

Force Guided Relays

RF Series



Enables flexible construction of safety circuits

Compact and EN compliant RF1V force guided relays.





(RF1V force guided relays)



(RF2 force guided relays)

• See website for details on approvals and standards.

	No. of Poles	Page
	6-pole	E-186
	4-pole	E-186
	2-pole	E-192

Force guided contact mechanism

EN 61810-3 Type A TÜV approved

Fast Response Time

Response time of 8ms.

Ensures safety by turning the load off quickly.

High Shock Resistance

High shock resistant suitable for use in machine tools and in environments subjected to vibration and shocks. (200m/s² minimum)

Clear Visibility

Available with a built-in LED.

Output expansion for safety relay modules and safety controllers

HR6S Safety Relay Module

Cost effective and easy method to expand mechanical contact outputs.



• Circuit Example

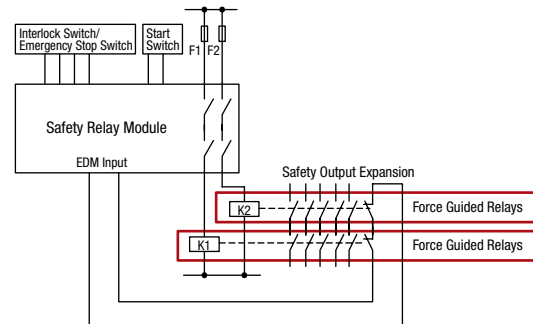

EDM input: External device monitor input

FS1B Safety Controller

Solid state safety outputs of safety controllers can be converted to mechanical contact outputs.



• Circuit Example

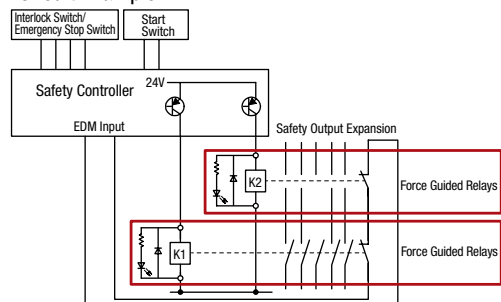

APEM

Switches & Pilot Lights

Control Boxes

Emergency Stop Switches

Enabling Switches

Safety Products

Explosion Proof

Terminal Blocks

Relays & Sockets

Circuit Protectors

Power Supplies

LED Illumination

Controllers

Operator Interfaces

Sensors

AUTO-ID

Interlock Switches

Non-contact Interlock Switches

Safety Laser Scanners

Safety Light Curtains

Safety Modules

FS1B

RF1V

RF2

HR2S

HR1S

RF1V Force-guided Relays / SF1V Relay Sockets

Compact and EN compliant RF1V force guided relays.

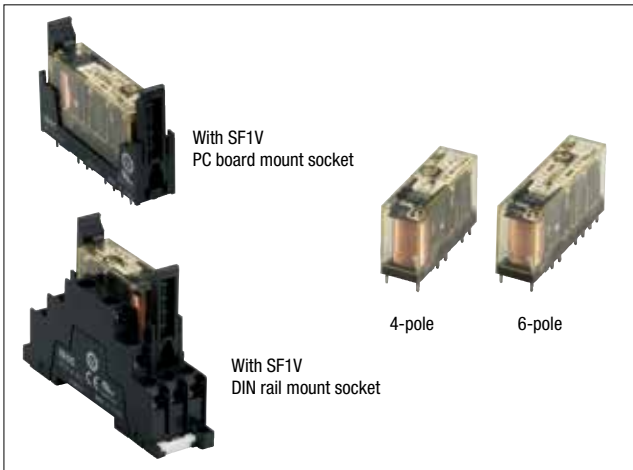

Package quantity: 10

Contact		Rated Coil Voltage	Without LED Indicator	With LED Indicator	With Counter-electromotive Force Diode With LED Indicator
			Part No.	Part No.	Part No.
4-pole	2NO-2NC	12V DC	RF1V-2A2B-D12	RF1V-2A2BL-D12	RF1V-2A2BLD1-D12
		24V DC	RF1V-2A2B-D24	RF1V-2A2BL-D24	RF1V-2A2BLD1-D24
		48V DC	RF1V-2A2B-D48	RF1V-2A2BL-D48	RF1V-2A2BLD1-D48
	3NO-1NC	12V DC	RF1V-3A1B-D12	RF1V-3A1BL-D12	RF1V-3A1BLD1-D12
		24V DC	RF1V-3A1B-D24	RF1V-3A1BL-D24	RF1V-3A1BLD1-D24
		48V DC	RF1V-3A1B-D48	RF1V-3A1BL-D48	RF1V-3A1BLD1-D48
6-pole	4NO-2NC	12V DC	RF1V-4A2B-D12	RF1V-4A2BL-D12	RF1V-4A2BLD1-D12
		24V DC	RF1V-4A2B-D24	RF1V-4A2BL-D24	RF1V-4A2BLD1-D24
		48V DC	RF1V-4A2B-D48	RF1V-4A2BL-D48	RF1V-4A2BLD1-D48
	5NO-1NC	12V DC	RF1V-5A1B-D12	RF1V-5A1BL-D12	RF1V-5A1BLD1-D12
		24V DC	RF1V-5A1B-D24	RF1V-5A1BL-D24	RF1V-5A1BLD1-D24
		48V DC	RF1V-5A1B-D48	RF1V-5A1BL-D48	RF1V-5A1BLD1-D48
	3NO-3NC	12V DC	RF1V-3A3B-D12	RF1V-3A3BL-D12	RF1V-3A3BLD1-D12
		24V DC	RF1V-3A3B-D24	RF1V-3A3BL-D24	RF1V-3A3BLD1-D24
		48V DC	RF1V-3A3B-D48	RF1V-3A3BL-D48	RF1V-3A3BLD1-D48

Sockets

Package quantity: 10

Types	No. of Poles	Part No.
DIN Rail Mount Sockets	4	SF1V-4-07L
	6	SF1V-6-07L
PC Board Mount Sockets	4	SF1V-4-61
	6	SF1V-6-61

Coil Ratings

Contact	Rated Coil Voltage (V)	Rated Current (mA) ±10% (at 20°C) (Note 1)	Coil Resistance (Ω) ±10% (at 20°C)	Operating Characteristics (at 20°C)			Power Consumption			
				Pickup Voltage (initial value)	Dropout Voltage (initial value)	Maximum allowable Voltage (Note 2)				
4-pole	2NO-2NC	12V DC	30.0	75% maximum	10% minimum	110%	Approx. 0.36W			
		24V DC	15.0							
		48V DC	7.5							
	3NO-1NC	12V DC	30.0							
		24V DC	15.0							
		48V DC	7.5							
6-pole	4NO-2NC	12V DC	41.7				75% maximum	10% minimum	110%	Approx. 0.50W
		24V DC	20.8							
		48V DC	10.4							
	5NO-1NC	12V DC	41.7							
		24V DC	20.8							
		48V DC	10.4							
	3NO-3NC	12V DC	41.7							
		24V DC	20.8							
		48V DC	10.4							

Note 1: For relays with LED indicator, the rated current increases by approx. 2mA.

Note 2: Maximum allowable voltage is the maximum voltage that can be applied to relay coils.

RF1V Force Guided Relays / SF1V Relay Sockets

Relay Specifications

Number of Poles		4-pole	6-pole
Contact Configuration		2NO-2NC	3NO-1NC
Contact Resistance (initial value) (Note 1)		100 mΩ maximum	4NO-2NC
Contact Material		AgSnO ₂ (Au flashed)	5NO-1NC
Rated Load (resistive load)		6A 250V AC, 6A 30V DC	3NO-3NC
Allowable Switching Power (resistive load)		1500 VA, 180W DC (30V DC max.), 85W DC (30V to 120V DC max.)	
Allowable Switching Voltage		250V AC, 125V DC	
Allowable Switching Current		6A	
Minimum Applicable Load (Note 2)		5V DC, 1 mA (reference value)	
Power Consumption (approx.)		0.36W	0.50W
Insulation Resistance		1000 MΩ minimum (500V DC megger, same measurement positions as the dielectric strength)	
Dielectric Strength	Between contact and coil	4000V AC, 1 minute	
	Between contacts of different poles	2500V AC, 1 minute Between contacts 7-8 and 9-10	2500V AC, 1 minute Between contacts 7-8 and 11-12 Between contacts 9-10 and 13-14 Between contacts 11-12 and 13-14
		4000V AC, 1 minute Between contacts 3-4 and 5-6 Between contacts 3-4 and 7-8 Between contacts 5-6 and 9-10	4000V AC, 1 minute Between contacts 3-4 and 5-6 Between contacts 3-4 and 7-8 Between contacts 5-6 and 9-10 Between contacts 7-8 and 9-10
	Between contacts of the same pole	1500V AC, 1 minute	
Operate Time (at 20°C)		20 ms maximum (at the rated coil voltage, excluding contact bounce time)	
Response Time (at 20°C) (Note 3)		8 ms maximum (at the rated coil voltage, excluding contact bounce time, without diode) (Note 4)	
Release Time (at 20°C)		20 ms maximum (at the rated coil voltage, excluding contact bounce time, without diode)	
Vibration Resistance	Operating Extremes	10 to 55 Hz, amplitude 0.75 mm	
	Damage Limits	10 to 55 Hz, amplitude 0.75 mm	
Shock Resistance	Operating Extremes (half sine-wave pulse: 11 ms)	200 m/s ² , when mounted on DIN rail mount socket: 150 m/s ²	
	Damage Limits (half sine-wave pulse: 6 ms)	1000 m/s ²	
Electrical Life		250V AC 6A resistive load: 100,000 operations minimum (operating frequency 1200 per hour) 30V DC 6A resistive load: 100,000 operations minimum (operating frequency 1200 per hour) 250V AC 1A resistive load: 500,000 operations minimum (operating frequency 1800 per hour) 30V DC 1A resistive load: 500,000 operations minimum (operating frequency 1800 per hour) [AC 15] 240V AC 2A inductive load: 100,000 operations minimum (operating frequency 1200 per hour, cos φ = 0.3) [DC 13] 24V DC 1A inductive load: 100,000 operations minimum (operating frequency 1200 per hour, L/R = 48 ms)	
Mechanical Life		10 million operations minimum (operating frequency 10,800 operations per hour)	
Operating Temperature (Note 5)		-40 to +85°C (no freezing)	
Operating Humidity		5 to 85%RH (no condensation)	
Storage Temperature		-40 to +85°C (no freezing)	
Storage Humidity		5 to 85%RH (no condensation)	
Operating Frequency (rated load)		1200 operations per hour	
Weight (approx.)		20g	23g

Note 1: Measured using 6V DC, 1A voltage drop method.

Note 2: Failure rate level P (reference value)

Note 3: Response time is the time until NO contact opens, after the coil voltage is turned off.

Note 4: With diode: 12ms maximum (at the rated coil voltage, excluding contact bounce time)

Note 5: See the table below for the current and operating temperature

Socket Specifications

Model	SF1V-4-07L	SF1V-6-07L	SF1V-4-61	SF1V-6-61
Rated Current	6A			
Rated Voltage	250V AC/DC			
Insulation Resistance	1000 MΩ minimum (500V DC megger, between terminals)			
Applicable Wire	0.7 to 1.65 mm ² (18 AWG to 14 AWG)		—	
Recommended Screw Tightening Torque	0.5 to 0.8 N·m		—	
Screw Terminal Style	M3 slotted Phillips self-tapping screw		—	
Terminal Strength	Wire tensile strength: 50N min.		—	
Dielectric Strength	2500V AC, 1 minute (Between live and dead metal parts, between live parts of different poles)			
Vibration Resistance	Damage limits: 10 to 55 Hz, amplitude 0.75 mm Resonance: 10 to 55 Hz, amplitude 0.75 mm			
Shock Resistance	1000 m/s ²			
Operating Temperature (Note)	-40 to +85°C (no freezing)			
Operating Humidity	5 to 85% RH (no condensation)			
Storage Temperature	-40 to +85°C (no freezing)			
Storage Humidity	5 to 85% RH (no condensation)			
Degree of Protection	IP20 (finger-safe screw terminals)		—	
Weight (approx.)	40g	55g	9g	10g

Note: See the table at right for the current and operating temperature.

Operating Temperature (relay, socket)

	Single mounting	Collective mounting	
Operating Temperature	-40°C to +85°C	4-pole	-40°C to +70°C
		6-pole	-40°C to +65°C
Contact Current	6A	6A	
Remarks	When the ambient temperature is over 70°C, lower the contact current at 0.1A/°C. 5NO1NC: Up to 70°C: Keep the total current of NO side to 24A maximum. Over 70°C: Lower the contact current at 0.1A/°C.	4-pole	When the ambient temperature is over 60°C, lower the contact current at 0.1A/°C.
		6-pole	When the ambient temperature is over 50°C, lower the contact current at 0.1A/°C. 5NO1NC: Up to 50°C: Keep the total current of NO side to 24A maximum. Over 50°C: Lower the contact current at 0.1A/°C.

Applicable Crimping Terminal

All dimensions in mm.

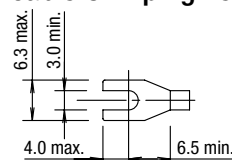

Note: Ring tongue terminals cannot be used.

Accessories

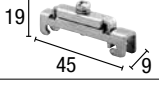
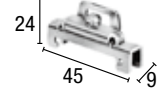
Item	Shape	Specifications	Part No.	Ordering Part No.	Package Quantity	Remarks
DIN Rail		Aluminum Weight: Approx. 200g	BAA1000	BAA1000PN10	10	Length: 1m Width: 35 mm
End Clip		Metal (zinc plated steel) Weight: Approx. 15g	BNL5	BNL5PN10	10	—
			BNL6	BNL6PN10	10	

Characteristics

Maximum Switching Capacity

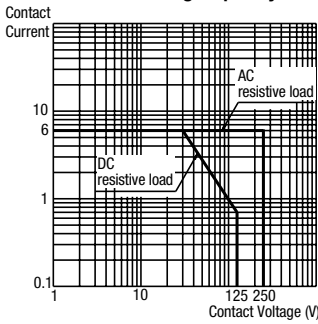

Electrical Life Curve

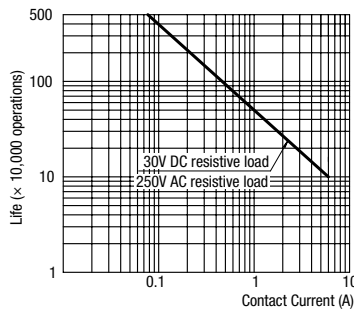

Notes on Contact Gaps except Welded Contacts

Example: RF1V-2A2B-D24

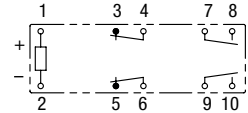

- If the NO contact (7-8 or 9-10) welds, the NC contact (3-4 or 5-6) remains open even when the relay coil is de-energized, maintaining a gap of 0.5 mm minimum. The remaining unwelded NO contact (9-10 or 7-8) is either open or closed.
- If the NC contact (3-4 or 5-6) welds, the NO contact (7-8 or 9-10) remains open even when the relay coil is energized, maintaining a gap of 0.5 mm minimum. The remaining unwelded NC contact (5-6 or 3-4) is either open or closed.

- APEM
- Switches & Pilot Lights
- Control Boxes
- Emergency Stop Switches
- Enabling Switches
- Safety Products
- Explosion Proof
- Terminal Blocks
- Relays & Sockets
- Circuit Protectors
- Power Supplies
- LED Illumination
- Controllers
- Operator Interfaces
- Sensors
- AUTO-ID
- Interlock Switches
- Non-contact Interlock Switches
- Safety Laser Scanners
- Safety Light Curtains
- Safety Modules
- FS1B
- RF1V
- RF2
- HR2S
- HR1S

Dimensions

(All dimensions in mm.)

RF1V Relays

RF1V (4-pole)

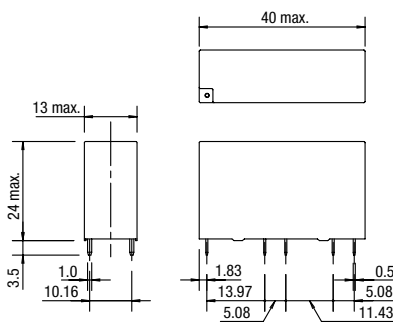

RF1V (6-pole)

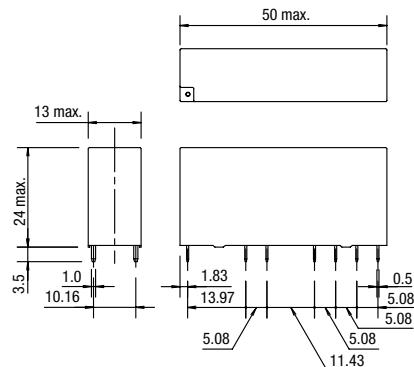

PC Board Terminal Model

Mounting Hole Layout (Bottom View)

RF1V (4-pole)

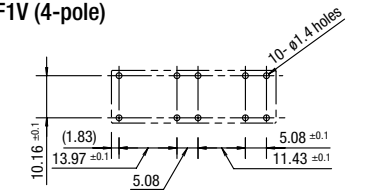

RF1V (6-pole)

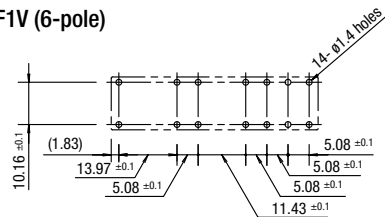

Internal Connection (Bottom View)

RF1V (4-pole)

Without LED Indicator

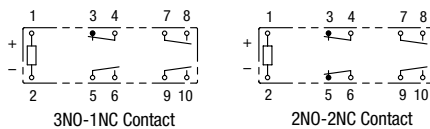

RF1V (6-pole)

Without LED Indicator

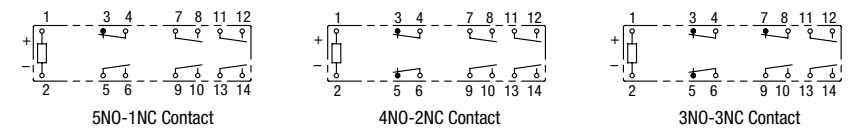

With LED Indicator

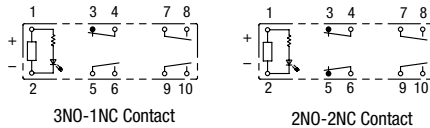

With LED Indicator

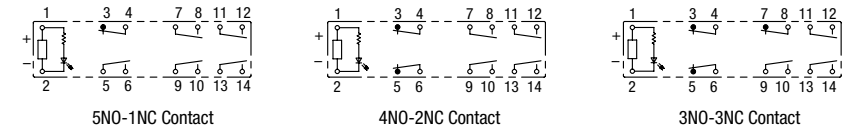

With Counter-electromotive Force Diode

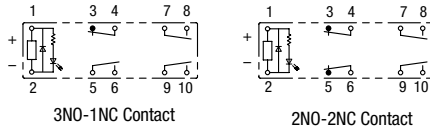

With Counter-electromotive Force Diode

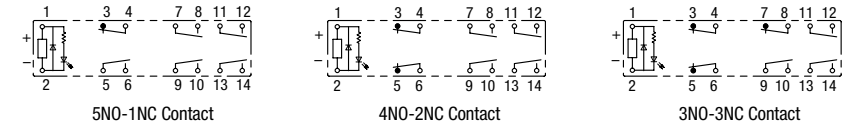

Dimensions

(All dimensions in mm.)

SF1V PC Board Mount Sockets

SF1V (4-pole)

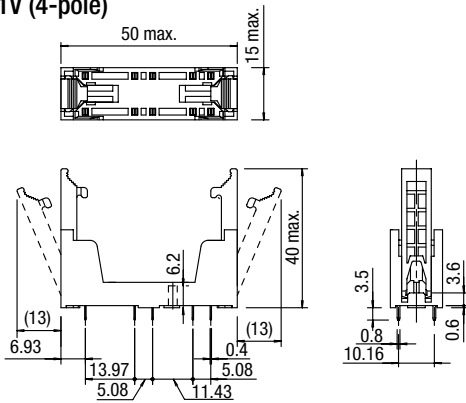

SF1V (6-pole)

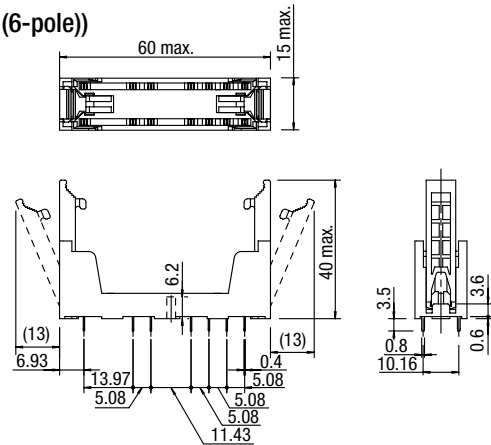

PC Board Mounting Hole Layout / Terminal Arrangement (Bottom View)

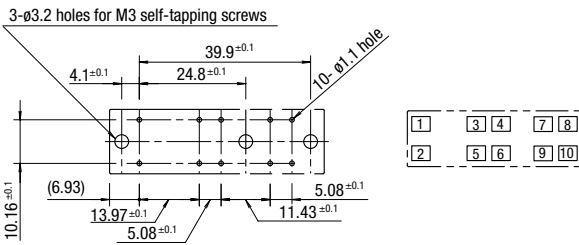

PC Board Mounting Hole Layout / Terminal Arrangement (Bottom View)

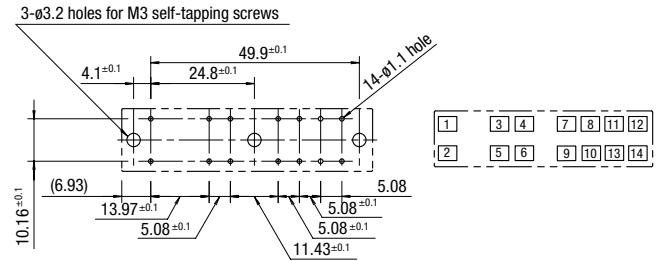

SF1V DIN Rail Mount Socket Dimensions

SF1V (4-pole)

(Internal Connection)

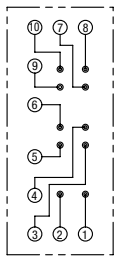

(Top View)

M3 Terminal Screws

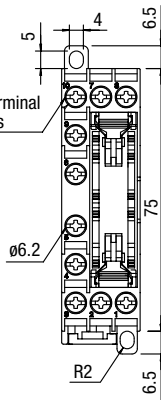

SF1V (6-pole)

(Internal Connection)

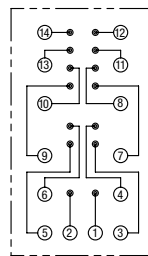

(Top View)

M3 Terminal Screws

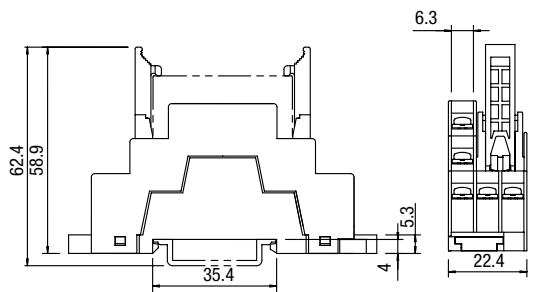
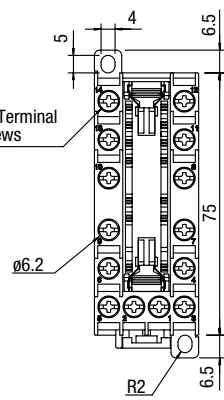

(Panel Mounting Hole Layout)

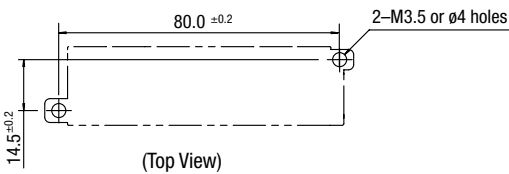

(Top View)

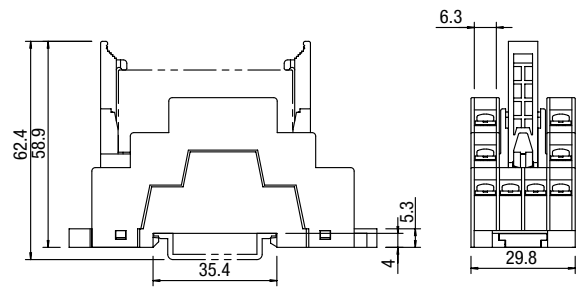

(Panel Mounting Hole Layout)

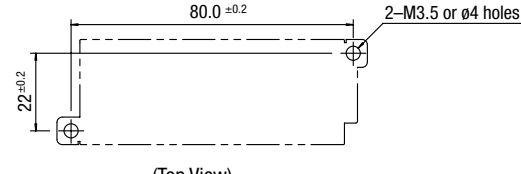

(Top View)

Operating Instructions

1. Driving Circuit for Relays

- To make sure of correct relay operation, apply rated voltage to the relay coil. Pickup and dropout voltages may differ according to operating temperature and conditions.
- Input voltage for DC coil:
A complete DC voltage is best for the coil power to make sure of stable operation. When using a power supply containing a ripple voltage, suppress the ripple factor within 5%. When power is supplied through a rectifications circuit, relay operating characteristics, such as pickup voltage and dropout voltage, depend on the ripple factor. Connect a smoothing capacitor for better operating characteristics as shown below.

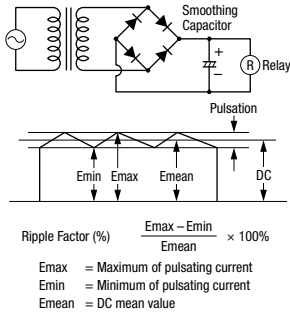

3. Operating the relay in sync with an AC load:

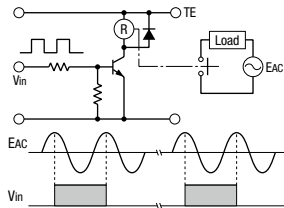

If the relay operates in sync with AC power voltage of the load, the relay life may be reduced. If this is the case, select a relay in consideration of the required reliability for the load. Or, make the relay turn on and off irrespective of the AC power phase or near the point where the AC phase crosses zero voltage.

4. Leakage current while relay is off:

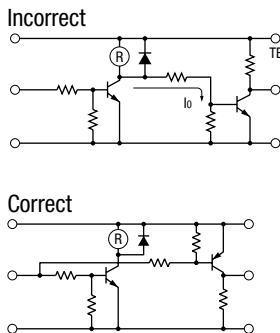

When driving an element at the same time as the relay operation, special consideration is needed for the circuit design. As shown in the incorrect circuit below, leakage current (I_o) flows through the relay coil while the relay is off. Leakage current causes coil release failure or adversely affects the vibration resistance and shock resistance. Design a circuit as shown in the correct example.

- Surge suppression for transistor driving circuits: When the relay coil is turned off, a high-voltage pulse is generated. Be sure to connect a diode to suppress the counter electromotive force, or use RF1V with counter-electromotive force diode. Then, the coil release time becomes slightly longer. To shorten the coil release time, connect a Zener diode between the collector and emitter of the controlling transistor. Select a Zener diode with a Zener voltage slightly higher than the power voltage.

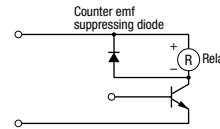

- The coil terminal of the relay has polarity. Connect terminals according to the internal connection diagram. Incorrect wiring may cause malfunction.

2. Protection for Relay Contacts

- The contact ratings show maximum values. Make sure that these values are not exceeded even momentarily. When an inrush current flows through the load, the contact may become welded. If this is the case, connect a contact protection circuit, such as a current limiting resistor.
- Contact protection circuit:
When switching an inductive load, arcing causes carbides to form on the contacts, resulting in an increased contact resistance. In consideration of contact reliability, contact life, and noise suppression, use of a surge absorbing circuit is recommended. Note that the release time of the load becomes slightly longer. Check the operation using an actual load. Incorrect use of a contact protection circuit will adversely affect switching characteristics. Four typical examples of contact protection circuits are shown in the following table:

RC		This protection circuit can be used when the load impedance is smaller than the RC impedance in an AC load power circuit. R: Resistor of approximately the same resistance value as the load C: 0.1 to 1 μ F
		This protection circuit can be used for both AC and DC load power circuits. R: Resistor of approximately the same resistance value as the load C: 0.1 to 1 μ F
Diode		This protection circuit can be used for DC load power circuits. Use a diode with the following ratings. Reverse withstand voltage: Power voltage of the load circuit \times 10 Forward current: More than the load current
Varistor		This protection circuit can be used for both AC and DC load power circuits. For a best result, when using on a power voltage of 24 to 48V AC/DC, connect a varistor across the load. When using on a power voltage of 100 to 240V AC/DC, connect a varistor across the contacts.

APEM

Switches & Pilot Lights

Control Boxes

Emergency Stop Switches

Enabling Switches

Safety Products

Explosion Proof

Terminal Blocks

Relays & Sockets

Circuit Protectors

Power Supplies

LED Illumination

Controllers

Operator Interfaces

Sensors

AUTO-ID

Interlock Switches

Non-contact Interlock Switches

Safety Laser Scanners

Safety Light Curtains

Safety Modules

FS1B

RF1V

RF2

HR2S

HR1S

Operating Instructions

3. Do not use a contact protection circuit as shown below:

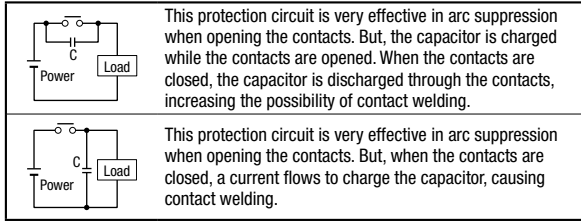

Generally, switching a DC inductive load is more difficult than switching a DC resistive load. Using an appropriate arc suppressor will improve the switching characteristics of a DC inductive load.

3. Usage, transport, and storage conditions

1. Temperature, humidity, atmospheric pressure during usage, transport, and storage.

- ① Temperature: -40°C to $+85^{\circ}\text{C}$ (no freezing)
See **E-187** for the current and operating temperature.
- ② Humidity: 5 to 85%RH (no condensation)
The humidity range varies with temperature. Use within the range indicated in the chart below.
- ③ Atmospheric pressure: 86 to 106 kPa
Operating temperature and humidity range

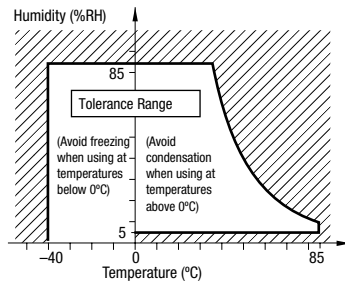

2. Condensation

Condensation occurs when there is a sudden change in temperature under high temperature and high humidity conditions. The relay insulation may deteriorate due to condensation.

3. Freezing

Condensation or other moisture may freeze on the relay when the temperatures is lower than 0°C . This causes problems such as sticking of movable parts or delay in operation.

4. Low temperature, low humidity environments

Plastic parts may become brittle when used in low temperature and low humidity environments.

4. Panel Mounting

When mounting DIN rail mount sockets on a panel, take the following into consideration.

- Use M3.5 screws, spring washers, and hex nuts.
- For mounting hole layout, see dimensions on **E-189**.
- Keep the tightening torque within 0.49 to 0.68 N·m. Excessive tightening may cause damage to the socket.

5. Others

1. General notice

- ① To maintain the initial characteristics, do not drop or shock the relay.
- ② The relay cover cannot be removed from the base during normal operation. To maintain the initial characteristics, do not remove the relay cover.
- ③ Use the relay in environments free from condensation, dust, sulfur dioxide (SO_2), and hydrogen sulfide (H_2S).
- ④ The RF1V relay cannot be washed as it is not a sealed type. Also make sure that flux does not leak to the PC board and enter the relay.

2. Connecting outputs to electronic circuits:

When the output is connected to a load which responds very quickly, such as an electronic circuit, contact bouncing causes incorrect operation of the load. Take the following measures into consideration.

- ① Connect an integration circuit.
 - ② Suppress the pulse voltage due to bouncing within the noise margin of the load.
3. Do not use relays in the vicinity of strong magnetic field, as this may affect relay operation.
 4. UL and CSA ratings may differ from product rated values determined by IDEC.

6. Notes on PC Board Mounting

- When mounting 2 or more relays on a PC board, keep a minimum spacing of 10 mm in each direction. If used without spacing of 10 mm, rated current and operating temperature differs. Consult IDEC.
- Manual soldering: Solder the terminals at 400°C within 3 sec.
- Auto-soldering: Preliminary heating at 120°C within 120 sec. Solder at $260^{\circ}\text{C} \pm 5^{\circ}\text{C}$ within 6 sec.
- Because the terminal part is filled with epoxy resin, do not excessively solder or bend the terminal. Otherwise, air tightness will degrade.
- Avoid the soldering iron from touching the relay cover or the epoxy filled terminal part.
- Use a non-corrosive resin flux.

RF2 2-pole Force Guided Relay / SJ Series Socket

For simple and easy safety measure. Reduce cost and installation space.

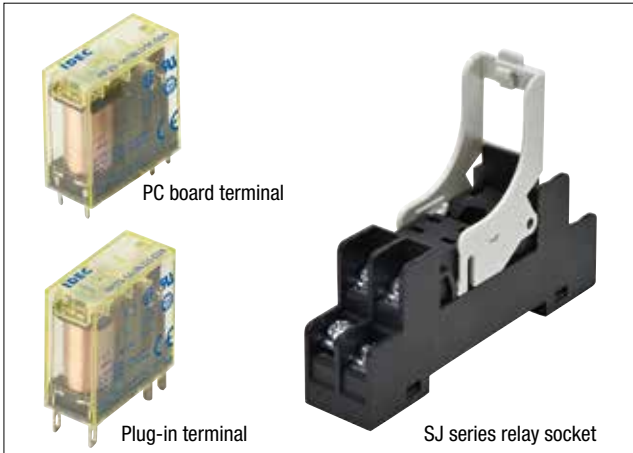

Force Guided Relays

Contact Configuration	Terminal Style	LED Indicator	w/diode of reverse polarity coil	Degree of Protection		Rated Coil Voltage	Part No.	
				Flux-tight (RTII)	Sealed (RTIII)			
2-pole	SPST-NO + SPST-NC	Plug-in	With	√	√	—	12V DC	RF2S-1A1BLD1-D12
			Without	—	√	—	24V DC	RF2S-1A1B-D24
			With	√	√	—		RF2S-1A1BD1-D24
			Without	—	√	—		RF2S-1A1BLD1-D24
			With	√	—	√		RF2S-1A1BLD1K-D24
			Without	—	√	—	48V DC	RF2S-1A1B-D48
	With	√	—	√	RF2S-1A1BLD1-D48			
	DPDT (*1)	Plug-in	Without	—	√	—	24V DC	RF2S-2C-D24
			Without	√	√	—	RF2S-2CD1-D24	
			With	√	√	—	RF2S-2CLD1-D24	
			With	√	—	√	RF2S-2CLD1K-D24	
	SPST-NO + SPST-NC	PC Board	Without	—	√	—	12V DC	RF2V-1A1B-D12
				—	√	—	24V DC	RF2V-1A1B-D24
				—	—	√	RF2V-1A1BK-D24	
√				√	—	RF2V-1A1BD1-D24		
√			—	√	RF2V-1A1BD1K-D24			
With			√	—	√	RF2V-1A1BLD1K-D24		
Without			—	√	—	48V DC	RF2V-1A1B-D48	
Without			—	√	—	24V DC	RF2V-2C-D24	

*1) When using DPDT model as a force guided relay, use in SPST-NO+SPST-NC wiring (EN50205).

• Other part numbers are available. See below (contact IDEC for details).

Part No. Development

RF	2	S	—	1A1B	LD1	K	—	D24					
Series	No. of Poles		Terminal Style		Contact Configuration		Option		Degree of Protection		Rated Coil Voltage		
	2	2-pole	S	Plug-in	1A1B	SPST-NO + SPST-NC		Blank	Standard		Blank	RTII	
			V	PC Board		L	With LED indicator		D	With diode (Note 1)			K
					2C	DPDT		D1	With diode of reverse polarity coil (Note 2)			D12	12V DC
								LD	With LED indicator & diode (Note 1)			D24	24V DC
								LD1	With LED indicator & diode of reverse polarity coil (Note 2)			D48	48V DC

Note 1: With diode: terminal 1 -, terminal 8 +

Note 2: With diode of reverse polarity coil: terminal 1 +, terminal 8 -

Note 3: Use this chart for interpreting part numbers. Not all possible variations can be realized.

APEM

Switches & Pilot Lights

Control Boxes

Emergency Stop Switches

Enabling Switches

Safety Products

Explosion Proof

Terminal Blocks

Relays & Sockets

Circuit Protectors

Power Supplies

LED Illumination

Controllers

Operator Interfaces

Sensors

AUTO-ID

Interlock Switches

Non-contact Interlock Switches

Safety Laser Scanners

Safety Light Curtains

Safety Modules

FS1A

RF1V

RF2

HR2S

HR1S

RF2 2-pole Force Guided Relay / SJ Series Socket

Standard Ratings

Voltage	UL Rating Resistive		CSA Rating Resistive	
	NO	NC	NO	NC
277V AC	6A	3A	6A	3A
30V DC	6A	3A	6A	3A

Voltage	TÜV Rating Resistive	
	NO	NC
240VAC	6A	3A
24V DC	6A	3A

Ratings

Coil ratings

Rated Voltage (V)	Rated Current (mA) ±15% (at 20°C)		Coil Resistance ±10% (at 20°C)	Operating Characteristics (against rated values at 20°C)			Power Consumption
	Without LED	With LED		Minimum Pickup Voltage	Dropout Voltage	Maximum Allowable Voltage (Note)	
12V DC	58	63	205	75% maximum	10% minimum	110%	Approx. 0.7W
24V DC	29	33	820				
48V DC	14.6	18	3300				

Note: Maximum allowable voltage is the maximum voltage that can be applied to relay coils.

Specifications

Model	RF2S (Plug-in Terminal)		RF2V (PC board terminal)	
No. of Poles	2-pole			
Contact Configuration	SPST-NO + SPST-NC, DPDT			
Disconnecting Means	Micro disconnection			
Contact Resistance (Note 1)	100mΩ maximum			
Contact Material	AgNi+Au-Clad			
Degree of Protection	RTII (flux-tight), RTIII (sealed)			
Rated Load (resistive load)	NO contact: 240V AC, 6A/24V DC, 6A NC contact: 240V AC, 3A/24V DC, 3A			
Contact	Maximum Allowable Power (resistive load)		NO contact: 1440VA/144W, NC contact: 720VA/72W	
	Maximum Allowable Voltage		250V AC, 125V DC	
	Maximum Allowable Current		6A	
Minimum Applicable Load (Note 2)	1V DC, 1mA			
Power Consumption	Approx. 0.7W			
Rated Insulation Voltage	250V			
Insulation Resistance	1000MΩ minimum (500V megger)			
Impulse Withstand Voltage	6000V			
Pollution Degree	2			
Dielectric Strength	Between contact and coil		5000V AC, 1 minute	
	Between contacts of the same pole		4000V AC, 1 minute	
	Between contacts of the different poles		1500V AC, 1 minute	
Operating Time	15ms max. (at the rated coil voltage, excluding contact bounce time)			
Response Time (Note 3)	5ms max. (at the rated coil voltage, without diode)			
	20ms max. (at the rated coil voltage, with diode)			
Release Time	10ms max. (at the rated coil voltage, excluding contact bounce time, without diode)			
	25ms max. (at the rated coil voltage, excluding contact bounce time, with diode)			
Vibration Resistance	Operating Extremes		NO contact: 10 to 55Hz, amplitude 0.75mm NC contact: 10 to 55Hz, amplitude 0.2mm	
	Damage Limits		10 to 55Hz, amplitude 0.75mm	
Shock Resistance	Operating Extremes		NO contact: 100m/s ² , NC contact: 50m/s ²	
	Damage Limits		1000m/s ²	
Electrical Life	NO contact: 100,000 operations minimum (operating frequency 1,800 per hour) at 240V 6A resistive load or 2A inductive load (power factor 0.4) 100,000 operations minimum (operating frequency 1,800 per hour) at 24V 6A resistive load or 1A inductive load (time constant 48ms) NC contact: 100,000 operations minimum (operating frequency 1,800 per hour) at 240V AC, 3A resistive load or 2A inductive load (power factor 0.4) 100,000 operations minimum (operating frequency 1,800 per hour) at 24V DC, 3A resistive load or 1A inductive load (time constant 48ms)			
Mechanical Life	10 million operations minimum (operating frequency 18,000 operations per hour)			
Operating Temperature	Single mounting: -40 to +70°C (no freezing) Collective mounting: -40 to +55°C (no freezing)		-40 to +70°C (no freezing)	
Operating Humidity	5 to 85%RH (no condensation)			
Storage Temperature	-40 to +85°C (no freezing)			
Weight (approx.)	18g (without LED/diode), 20g (with LED/with diode/with LED & diode)			

• Above values are initial values.

Note 1: Measured using 5V DC, 1A voltage drop method.

Note 2: Failure rate level P, reference value

Note 3: Response time is the time until NO contact opens, after the coil voltage is turned off.

SJ Series Relay Socket



• See website for details on approvals and standards.
 Note: Sockets can be used on RF2S (Plug-in terminal) only.

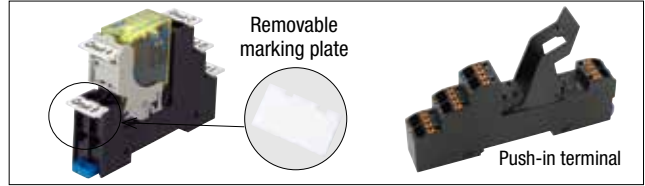

Sockets

Package Quantity: 1

	Terminal Style	Part No.	Ordering No.	Package Quantity
DIN-rail Socket (*1)	Standard Screw Terminal	SJ2S-05BS	SJ2S-05BS	1
	Fingersafe Screw Terminal	SJ2S-07L	SJ2S-07L	1
	Push-in Terminal	SJ2S-21L	SJ2S-21L	1
PC Board Socket		SJ2S-61	SJ2S-61PN10	10
		SJ2S-61	SJ2S-05PN50	50

*1) Release lever is supplied with the socket.
 • See website for details on PC board socket.

Accessories and Replacement Parts (for DIN-rail Socket)

Description/Shape	Applicable Socket Part No.	Material	Part No.	Ordering No.	Package Quantity	Remarks
Removable Marking Plate	SJ2S-07L	Plastic (white)	SJ9Z-PW	SJ9Z-PWPN10	10	Marking area
	SJ2S-21L		SJ9Z-P2100W	SJ9Z-P2100W		
Jumper (*2)	For 8 sockets	brass with polypropylene coating	SJ9Z-JF8S	SJ9Z-JF8S	10	Terminal centers: 15.8mm Rated current: 12A Terminal centers: 15.5mm Rated current: 12A A2 terminal of the coil is connected. The rated current is 2A.
	For 2 sockets		SJ9Z-JF2	SJ9Z-JF2PN10		
	For 5 sockets	Nickel-coated brass with polypropylene coating	SJ9Z-JF5	SJ9Z-JF5PN10		
	For 8 sockets		SJ9Z-JF8	SJ9Z-JF8PN10		
	For 10 sockets	SJ9Z-JF10	SJ9Z-JF10PN10			
For 2 sockets	Zinc-plated steel with polybutylene terephthalate coating	SU9Z-J2102A	SU9Z-J2102A			
Release Lever	SJ2S-05BS		SJ9Z-CS	SJ9Z-CS		-
Release Lever (with integrated marking plate)	SJ2S-07L	Plastic	SJ9Z-CM	SJ9Z-CMPN05	5	A part of the release lever can be cut off with nippers, etc. and used as a marking plate. Marking area
Release Lever	SJ2S-21L		SJ9Z-C21R	SJ9Z-C21R		

*2) Ensure that the total current to the jumper does not exceed the maximum current. *3) Used for Push-in terminals.

Socket Specifications

Model	SJ2S-05BS, SJ2S-07L (DIN Rail Socket)	SJ2S-61 (PC Board Socket)	SJ2S-21L (Push-in Terminal Socket)
Rated Current	8A		
Rated Insulation Voltage	250V AC/DC		300V AC/DC (*5)
Applicable Wire	2mm ²	-	Solid wire / stranded wire: 0.14 to 1.5mm ² , AWG26 to 16 Stranded wire with ferrule (without insulated cover): 0.5 to 1.5mm ² , AWG20 to 16 Stranded wire with ferrule (with insulated cover): 0.14 to 1.0mm ² , AWG26 to 18
Applicable Crimping Terminal	See the dimensions shown at right	-	-
Recommended Tightening Torque	SJ2S-05BS: 0.6 to 1.0N·m SJ2S-07L: 1.0N·m	-	-
Screw Terminal Style	M3 slotted Phillips screw (self-lifting)	-	-
Terminal Strength	Wire tensile strength: 50N minimum	-	-
Dielectric Strength (*4)	Between contact and coil	4000V AC, 1 min.	5000V AC, 1 min.
	Between contacts of the same pole	1000V AC, 1 min.	2500V AC, 1min. (between live and dead metal parts, between live metal parts of the different poles)
	Between contacts of the different pole	3000V AC, 1 min.	-
Vibration Resistance	Damage limits	Frequency 10 to 55Hz, amplitude 1.5mm	90m/s ² Frequency 10 to 55Hz, amplitude 0.75mm
	Resonance	-	10 to 55Hz, amplitude 1.5mm
Shock Resistance (damage limits)	100G (when using release lever)	1000m/s ²	50G (when using release lever)
Operating Temperature	-40 to +70°C (no freezing)		
Operating Humidity	5 to 85% RH (no condensation)		
Storage Temperature	-55 to +85°C (no freezing)		-40 to +70°C (no freezing)
Degree of Protection (Screw Terminal)	SJ2S-07L: IP20 (IEC 60529)	-	-
Weight	SJ2S-05BS: 30g, SJ2S-07L: 34g	4.5g	43g

*4) The above are same when used with a RF2 force guided relay. *5) When using the socket with RF2S Force Guided Relay, the rated insulation voltage is 150V AC/DC.

Applicable Crimping Terminal

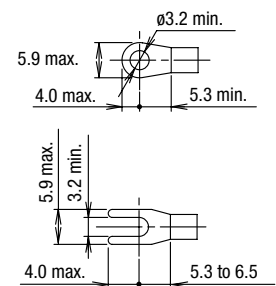

Note: Ring terminal cannot be used on SJ2S-07L.
 See Cat. No. EP1728 for applicable terminals on Push-in terminals.

APEM

Switches & Pilot Lights

Control Boxes

Emergency Stop Switches

Enabling Switches

Safety Products

Explosion Proof

Terminal Blocks

Relays & Sockets

Circuit Protectors

Power Supplies

LED Illumination

Controllers

Operator Interfaces

Sensors

AUTO-ID

Interlock Switches

Non-contact Interlock Switches

Safety Laser Scanners

Safety Light Curtains

Safety Modules

FS1B

RF1V

RF2

HR2S

HR1S

Dimensions

(All dimensions in mm.)

Relay Dimensions

**RF2S (plug-in terminal)
Standard (without LED/diode)**

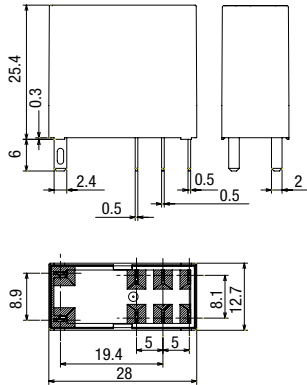

**RF2V (PC board terminal)
Standard (without LED/diode)**

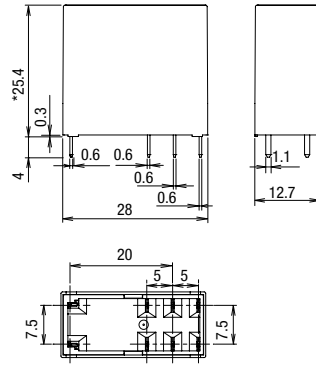

**PC Board Terminal Mounting Hole
Layout (Bottom View)**

RF2V (SPST-N0 + SPST-NC)

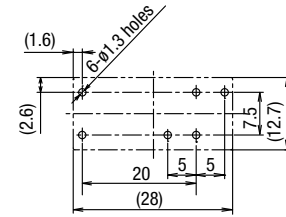

RF2V (DPDT)

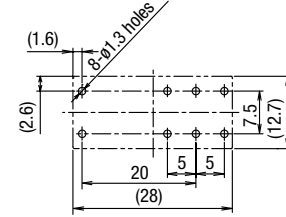

* With LED/diode: 28.4

Socket Dimensions

SJ2S-05BS

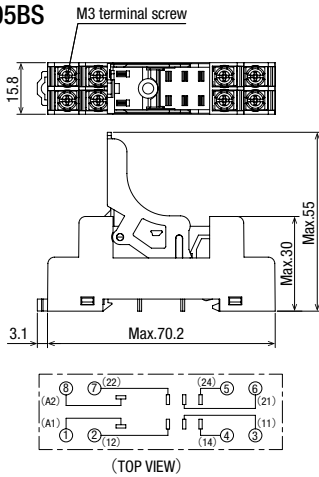

SJ2S-07L

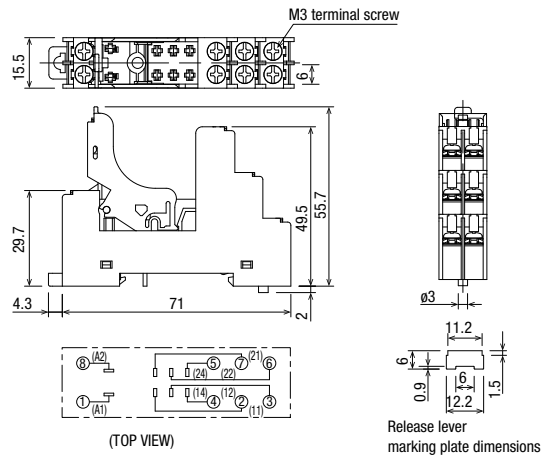

SJ2S-21L

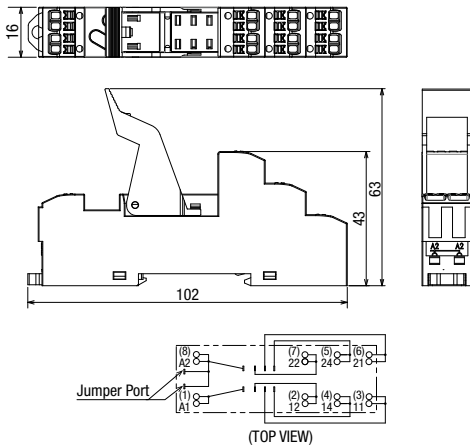

SJ2S-61

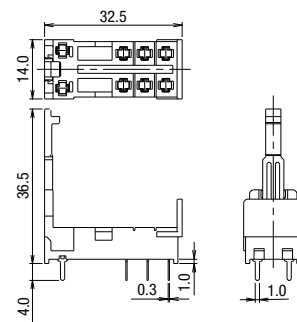

SJ9Z-CS (Release Lever)

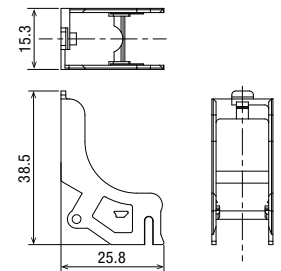

SJ9Z-CM (Release Lever)

• When the marking plate is not used on the release lever.

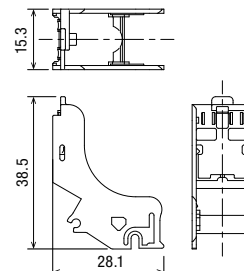

SJ9Z-C21R (Release Lever)

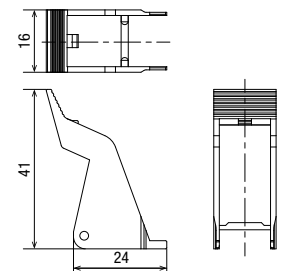

Dimensions

(All dimensions in mm.)

Internal Connection (Bottom View)

RF2*-1A1B-□
Standard

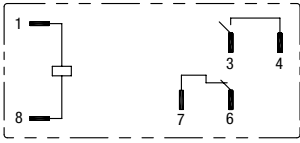

RF2*-1A1BLD1-□
With LED indicator + diode of reverse polarity coil

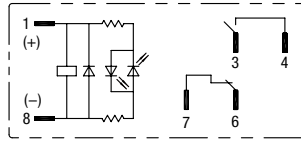

RF2*-1A1BLD-□
With LED indicator + diode

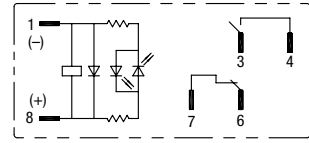

RF2*-2C-□
Standard

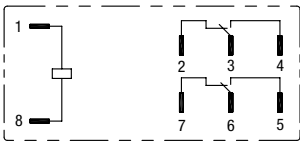

RF2*-2CLD1-□
With LED indicator + diode of reverse polarity coil

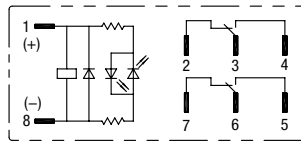

RF2*-2CLD-□
With LED indicator + diode

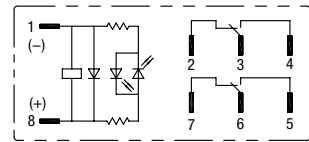

RF2*-1A1BL-□
With LED indicator

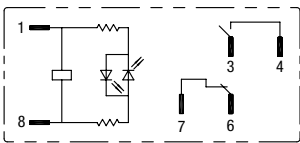

RF2*-1A1BD1-□
With diode of reverse polarity coil

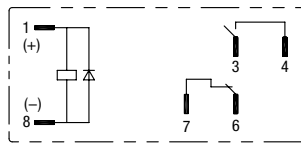

RF2*-1A1BD-□
With diode

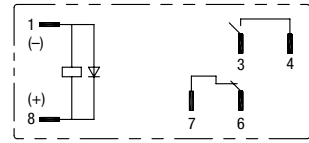

RF2*-2CL-□
With LED indicator

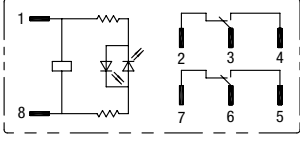

RF2*-2CD1-□
With diode of reverse polarity coil

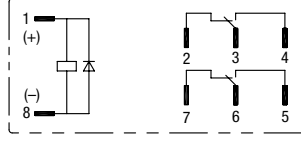

RF2*-2CD-□
With diode

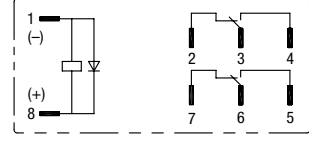

- Relays with diode have polarity. Take polarity into consideration when wiring.
- When using DPDT model as a force guided relay, use in SPST-NO + SPST-NC wiring (EN50205).

APEM

Switches & Pilot Lights

Control Boxes

Emergency Stop Switches

Enabling Switches

Safety Products

Explosion Proof

Terminal Blocks

Relays & Sockets

Circuit Protectors

Power Supplies

LED Illumination

Controllers

Operator Interfaces

Sensors

AUTO-ID

Interlock Switches

Non-contact Interlock Switches

Safety Laser Scanners

Safety Light Curtains

Safety Modules

FS1B

RF1V

RF2

HR2S

HR1S

Operating Instructions

1. When using DPDT model as a force guided relay

Use in SPST-NO + SPST-NC wiring according to EN50205 (2002)

RF2*-2C-□

Standard

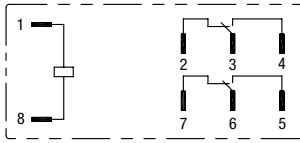

Example:

Use terminal 3-4 as NO contact and 6-7 as NC contact. Or terminal 2-3 as NC contact and terminal 5-6 as NO contact.

2. Driving Circuit for Relays

2-1. To make sure of correct relay operation, apply rated voltage to the relay coil. Pickup and dropout voltages may differ according to operating temperature and conditions.

2-2. Input voltage for DC coil:

A complete DC voltage is best for the coil power to make sure of stable operation. When using a power supply containing a ripple voltage, suppress the ripple factor within 5%. When power is supplied through a rectification circuit, the relay operating characteristics, such as pickup voltage and dropout voltage, depend on the ripple factor. Connect a smoothing capacitor for better operating characteristics as shown below.

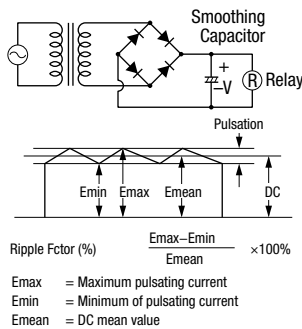

2-3. Operating the relay in sync with an AC load:

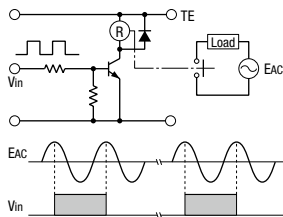

If the relay operates in sync with AC power voltage of the load, the relay life may be reduced. If this is the case, select a relay in consideration of the required reliability for the load. Or, make the relay turn on and off irrespective of the AC power phase or near the point where the AC phase crosses zero voltage.

2-4. Leakage current while relay is OFF

When driving an element at the same time as the relay operation, special consideration is needed for the circuit design. As shown in the incorrect circuit at right, leakage current (I_0) flows through the relay coil while the relay is off.

Leakage current causes coil release failure or adversely affects the vibration resistance and shock resistance. Design a circuit as shown in the correct example.

Correct

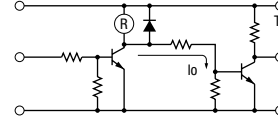

Incorrect

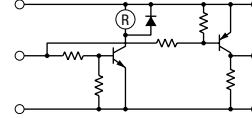

2-5. Surge suppression for transistor driving circuits:

When the relay coil is turned off, a high-voltage pulse is generated. Be sure to connect a diode to suppress the counter electromotive force. Then, the coil release time becomes slightly longer. To shorten the coil release time, connect a Zener diode between the collector and emitter of the controlling transistor. Select a Zener diode with a Zener voltage slightly higher than the power voltage.

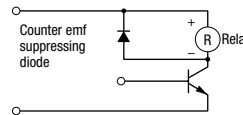

2-6. The coil terminal of the relay has polarity.

Connect terminals according to the internal connection diagram. Incorrect wiring may cause malfunction.

APEM

Switches & Pilot Lights

Control Boxes

Emergency Stop Switches

Enabling Switches

Safety Products

Explosion Proof

Terminal Blocks

Relays & Sockets

Circuit Protectors

Power Supplies

LED Illumination

Controllers

Operator Interfaces

Sensors

AUTO-ID

Interlock Switches

Non-contact Interlock Switches

Safety Laser Scanners

Safety Light Curtains

Safety Modules

FS1B

RF1V

RF2

HR2S

HR1S

Operating Instructions

3. Protection for Relay Contacts

3-1. The contact ratings show maximum values. Make sure that these values are not exceeded. When an inrush current flows through the load, the contact may become welded. If this is the case, connect a contact protection circuit, such as a current limiting resistor.

3-2. Contact protection circuit:

When switching an inductive load, arcing causes carbides to form on the contacts, resulting in an increased contact resistance. In consideration of contact reliability, contact life, and noise suppression, use of a surge absorbing circuit is recommended. Note that the release time of the load becomes slightly longer. Check the operation using an actual load. Incorrect use of a contact protection circuit will adversely affect switching characteristics. Four typical examples of contact protection circuits are shown in the following table:

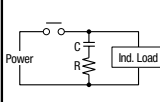
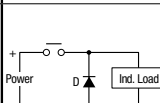
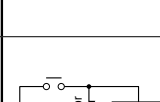
RC		This protection circuit can be used for both AC and DC load power circuits. R: Resistor of approximately the same resistance value as the load. C: 0.1 to 1 μ F
Diode		This protection circuit can be used for DC load power circuits. Use a diode with the following ratings. Reverse withstand voltage: Power voltage of the load circuit \times 10 Forward current: More than the load current
Varistor		This protection circuit can be used for both AC and DC load power circuits. For the best result, when using on a power voltage of 24 to 48V AC/DC, connect a varistor across the load. When using on a power voltage of 100 to 240V AC/DC, connect a varistor across the contacts.

3-3. Do not use a contact protection circuit as shown below:

	This protection circuit is very effective in arc suppression when opening the contacts. But, when the contacts are closed, a current flows to charge the capacitor, causing contact welding.
---	--

Generally, switching a DC inductive load is more difficult than switching a DC resistive load. Using an appropriate arc suppressor will improve the switching characteristics of a DC inductive load.

4. Usage, transport, and storage conditions

4-1. Condensation

Condensation occurs when there is a sudden change in temperature under high temperature and high humidity conditions. The relay insulation may deteriorate due to condensation.

4-2. Freezing

Condensation or other moisture may freeze on the relay when the temperatures is lower than 0°C. This causes problems such as sticking of movable parts or delay in operation.

4-3. Low temperature, low humidity environments

Plastic parts may become brittle when used in low temperature and low humidity environments.

5. Other Notices

5-1. General notice:

- ① To maintain the initial characteristics, do not drop or shock the relay.
- ② The relay cover cannot be removed from the base during normal operation. To maintain the initial characteristics, do not remove the relay cover.
- ③ Use the relay in environments free from condensation, dust, sulfur dioxide (SO₂), and hydrogen sulfide (H₂S).
- ④ RTII model cannot be washed as it is not a sealed type. Also make sure that flux does not leak to the PC board and enter the relay.
- ⑤ Make sure that the voltage applied to the coil continuously does not exceed the maximum allowable voltage.

5-2. Connecting outputs to electronic circuits:

When the output is connected to a load which responds very quickly, such as an electronic circuit, contact bouncing causes incorrect operation of the load. Take the following measures into consideration.

- ① Connect an integration circuit.
- ② Suppress the pulse voltage due to bouncing within the noise margin of the load.

5-3. Do not use relays in the vicinity of strong magnetic fields, as this may affect relay operation.

5-4. UL and CSA ratings may differ from product rated values determined by IDEC.

5-5. Others

- Shock Resistance

For the best shock resistance, it is ideal to install the RF2 relay so that the armature movement is perpendicular to the direction of vibration/shock.

- Life

Large loads that causes arcs may result in the contact material scattered off, accumulating around the contact. This will degrade insulation resistance between the circuits. Make sure that the relay is mounted in the correct direction.

- Counter-electromotive force model (diode)

Counter-electromotive force diode model has polarity. The diode absorbs counter-electromotive force of relay coil. When excessive external surge voltage is anticipated, take additional counter-electromotive force measures. Otherwise the diode may be damaged. When using general purpose relays and force guided relays closely, use of a marking plate (optional) on the release lever or socket is recommended, so that force guided relay can be recognized easily.

6. Notes on PC Board Mounting

- When mounting two or more relays on a PC board, keep a minimum spacing of 5 mm in each direction. If used without spacing of 10 mm, rated current and operating temperature differs. Consult IDEC.
- Manual soldering: Solder the terminals at 350°C within 3 sec.
- Auto-soldering: Preliminary heating at 120°C within 60 sec. Solder at 250°C within 4 to 5 sec.
- Because the terminal part is filled with epoxy resin, do not excessively solder or bend the terminal. Otherwise, air tightness will degrade.
- Avoid the soldering iron from touching the relay cover or the epoxy filled terminal part. Use a non-corrosive resin flux.
- Do not install the relay on the PC board in the way the PC board is bent, otherwise copper foil may be cut or solder may be displaced after operating for a long time or due to vibration, degrading the relay's performance.
- When multiple PC boards with relays are mounted to a rack, the temperature may rise excessively. When mounting relays, leave enough space so that heat will not build up, and so that the relays' ambient temperature remains within the specified operating temperature range.

Ordering Terms and Conditions

Thank you for using IDEC Products.

By purchasing products listed in our catalogs, datasheets, and the like (hereinafter referred to as "Catalogs") you agree to be bound by these terms and conditions. Please read and agree to the terms and conditions before placing your order.

1. Notes on contents of Catalogs

- (1) Rated values, performance values, and specification values of IDEC products listed in this Catalog are values acquired under respective conditions in independent testing, and do not guarantee values gained in combined conditions.
Also, durability varies depending on the usage environment and usage conditions.
- (2) Reference data and reference values listed in Catalogs are for reference purposes only, and do not guarantee that the product will always operate appropriately in that range.
- (3) The specifications / appearance and accessories of IDEC products listed in Catalogs are subject to change or termination of sales without notice, for improvement or other reasons.
- (4) The content of Catalogs is subject to change without notice.

2. Note on applications

- (1) If using IDEC products in combination with other products, confirm the applicable laws / regulations and standards.
Also, confirm that IDEC products are compatible with your systems, machines, devices, and the like by using under the actual conditions. IDEC shall bear no liability whatsoever regarding the compatibility with IDEC products.
- (2) The usage examples and application examples listed in Catalogs are for reference purposes only. Therefore, when introducing a product, confirm the performance and safety of the instruments, devices, and the like before use. Furthermore, regarding these examples, IDEC does not grant license to use IDEC products to you, and IDEC offers no warranties regarding the ownership of intellectual property rights or non-infringement upon the intellectual property rights of third parties.
- (3) When using IDEC products, be cautious when implementing the following.
 - i. Use of IDEC products with sufficient allowance for rating and performance
 - ii. Safety design, including redundant design and malfunction prevention design that prevents other danger and damage even in the event that an IDEC product fails
 - iii. Wiring and installation that ensures the IDEC product used in your system, machine, device, or the like can perform and function according to its specifications
- (4) Continuing to use an IDEC product even after the performance has deteriorated can result in abnormal heat, smoke, fires, and the like due to insulation deterioration or the like. Perform periodic maintenance for IDEC products and the systems, machines, devices, and the like in which they are used.
- (5) IDEC products are developed and manufactured as general-purpose products for general industrial products. They are not intended for use in the following applications, and in the event that you use an IDEC product for these applications, unless otherwise agreed upon between you and IDEC, IDEC shall provide no guarantees whatsoever regarding IDEC products.
 - i. Use in applications that require a high degree of safety, including nuclear power control equipment, transportation equipment (railroads / airplanes / ships / vehicles / vehicle instruments, etc.), equipment for use in outer space, elevating equipment, medical instruments, safety devices, or any other equipment, instruments, or the like that could endanger life or human health
 - ii. Use in applications that require a high degree of reliability, such as provision systems for gas / waterworks / electricity, etc., systems that operate continuously for 24 hours, and settlement systems
 - iii. Use in applications where the product may be handled or used deviating from the specifications or conditions / environment listed in the Catalogs, such as equipment used outdoors or applications in environments subject to chemical pollution or electromagnetic interference
If you would like to use IDEC products in the above applications, be sure to consult with an IDEC sales representative.

3. Inspections

We ask that you implement inspections for IDEC products you purchase without delay, as well as thoroughly keep in mind management/maintenance regarding handling of the product before and during the inspection.

4. Warranty

- (1) Warranty period
The warranty period for IDEC products shall be one (1) year after purchase or delivery to the specified location. However, this shall not apply in cases where there is a different specification in the Catalogs or there is another agreement in place between you and IDEC.
- (2) Warranty scope
Should a failure occur in an IDEC product during the above warranty period for reasons attributable to IDEC, then IDEC shall replace or repair that product, free of charge, at the purchase location / delivery location of the product, or an IDEC service base. However, failures caused by the following reasons shall be deemed outside the scope of this warranty.
 - i. The product was handled or used deviating from the conditions / environment listed in the Catalogs
 - ii. The failure was caused by reasons other than an IDEC product
 - iii. Modification or repair was performed by a party other than IDEC
 - iv. The failure was caused by a software program of a party other than IDEC
 - v. The product was used outside of its original purpose
 - vi. Replacement of maintenance parts, installation of accessories, or the like was not performed properly in accordance with the user's manual and Catalogs
 - vii. The failure could not have been predicted with the scientific and technical standards at the time when the product was shipped from IDEC
 - viii. The failure was due to other causes not attributable to IDEC (including cases of force majeure such as natural disasters and other disasters)Furthermore, the warranty described here refers to a warranty on the IDEC product as a unit, and damages induced by the failure of an IDEC product are excluded from this warranty.

5. Limitation of liability

The warranty listed in this Agreement is the full and complete warranty for IDEC products, and IDEC shall bear no liability whatsoever regarding special damages, indirect damages, incidental damages, or passive damages that occurred due to an IDEC product.

6. Service scope

The prices of IDEC products do not include the cost of services, such as dispatching technicians. Therefore, separate fees are required in the following cases.

- (1) Instructions for installation / adjustment and accompaniment at test operation (including creating application software and testing operation, etc.)
- (2) Maintenance inspections, adjustments, and repairs
- (3) Technical instructions and technical training
- (4) Product tests or inspections specified by you

The above content assumes transactions and usage within your region. Please consult with an IDEC sales representative regarding transactions and usage outside of your region. Also, IDEC provides no guarantees whatsoever regarding IDEC products sold outside your region.

IDEC CORPORATION

Head Office 6-64, Nishi-Miyahara-2-Chome, Yodogawa-ku, Osaka 532-0004, Japan

USA IDEC Corporation
EMEA APEM SAS

Singapore IDEC Izumi Asia Pte. Ltd.
Thailand IDEC Asia (Thailand) Co., Ltd.
India IDEC Controls India Private Ltd.

China IDEC (Shanghai) Corporation
IDEC Izumi (H.K.) Co., Ltd.
Taiwan IDEC Taiwan Corporation

Japan IDEC Corporation

 www.idec.com

Specifications and other descriptions in this brochure are subject to change without notice.

2024 IDEC Corporation, All Rights Reserved.

