

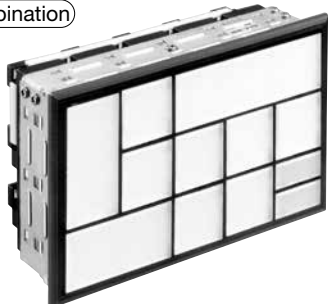

Series		SLC Series Combination Display Lights	
Model		SLC30	
Shape		<p>(An example of 15-window combination) Spot illumination is available with Type F only.</p>  	
Light Source		LED Unit	LED lamp (LFTD) (SX6S/8 base)
No. of Units		Basic (Type F) 1 for 1 window	Half Size (Type C) 1 for 1 window
Illumination Face Size		F, H, L, V, G	C only
			Type F (30 × 30mm) Type H (30 × 60mm) Type L (30 × 90mm) Type V (60 × 30mm) Type G (60 × 60mm) Type C (15 × 30mm) (split-window)
Illumination Color		A (amber), G (green), PW (pure white) *, R (red), S (blue), Y (yellow), Red (R)/G (green) * PW is available with Type F only	A (amber), G (green), PW (pure white), R (red), S (blue), Y (yellow)
Rated Voltage		12, 24V AC/DC (full voltage) 100/110, 200/220V AC (transformer) 110V DC (DC-DC converter) 100/110V AC/DC (resistor)	12, 24V AC/DC (full voltage)
Lens Frame Color & Frame Cover Color		Black (Munsell N1.5 equivalent)	
Terminal Screw		M3.5, Check terminal: M3	
No. of Windows	Full Voltage	1 to 200 (Type F equivalent)	1 to 50 (Type F equivalent)
	Transformer/Resistor	1 to 75 (Type F equivalent)	—
	DC-DC Converter		—
Degree of Protection		IP40 (IEC 60529)	
Remarks		<ul style="list-style-type: none"> • Jumper available • 2-color alternate, check terminal 	
Approvals		UL, c-UL, DEMKO, CE (Note)	—
Page		5	

Note: Except for DC-DC converter and resistor

SLC Series Combination Display Lights	
SLC40	
<p>(An example of 12-window combination)</p> <p>Spot illumination is available with Type F only.</p> 	
LED Unit	LED lamp (LSRD) (BA9S/13 base)
Basic (Type F) 1 for 1 window	Half Size (Type C) 1 for 1 window
F, H, L, V, G	C only
 <p>Type F (40 × 40mm) Type H (40 × 80mm) Type L (40 × 120mm) Type V (80 × 40mm) Type G (80 × 80mm) Type C (20 × 40mm) (split-window)</p>	
A (amber), G (green), PW (pure white) *, R (red), S (blue), Y (yellow), Red (R)/G (green) * PW is available with Type F only	A (amber), G (green), PW (pure white), R (red), S (blue), Y (yellow)
24V AC/DC (full voltage) 100/110, 200/220V AC (transformer) 110V DC (DC-DC converter) 100/110V AC/DC (resistor)	24V AC/DC (full voltage)
Black (Munsell N1.5 equivalent)	
M3.5 2-color illumination, Type C, Check terminal: M3	
1 to 126 (Type F equivalent)	1 to 105 (Type F equivalent)
1 to 60 (Type F equivalent)	—
IP40 (IEC 60529)	
<ul style="list-style-type: none"> • Extensive windows are easy to recognize at high places. • Jumper available • 2-color alternate, check terminal 	
UL, c-UL, DEMKO, CE (Note)	—

Series	Combination Display with Control Units	
Model	SLC30 Series (SLC30 + SLC-LW)	
Shape		
No. of Windows	<ul style="list-style-type: none"> Combination display lights: 29 maximum Control units: 10 maximum (the bottom row only) Total 30 maximum	
Combination Display Lights	<ul style="list-style-type: none"> SLC30 series one-color (window 30 × 30mm) Illumination color: A (amber), G (green), PW (pure white), R (red), S (blue), Y (yellow) 	
	Ratings	Rated voltage: 24V AC/DC Operating voltage: 24V AC/DC ±10%
Control Unit	<ul style="list-style-type: none"> Pushbutton (square, round with square bezel, momentary) Illuminated pushbutton (square, round with square bezel, momentary) Selector switch (2, 3 positions, round with square bezel) Key selector switch (2, 3 positions, round with square bezel) 	
	Contact Ratings (Resistive Load)	<ul style="list-style-type: none"> Rated insulation voltage: 250V AC/DC Rated current: 3A/gold, 5A/silver Gold contact: 125V AC/0.1A, 30V DC/0.1A Silver contact: 125V AC/3A, 250V AC/2A, 30V DC/2A, 125V DC/0.4A
Lens Frame Color & Frame Cover Color	Black (Munsell N1.5 equivalent)	
Degree of Protection	IP40 (IEC 60529)	
Page	37	

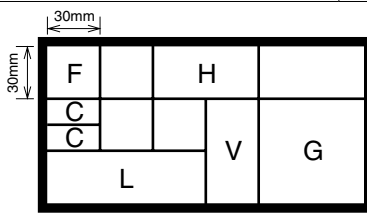
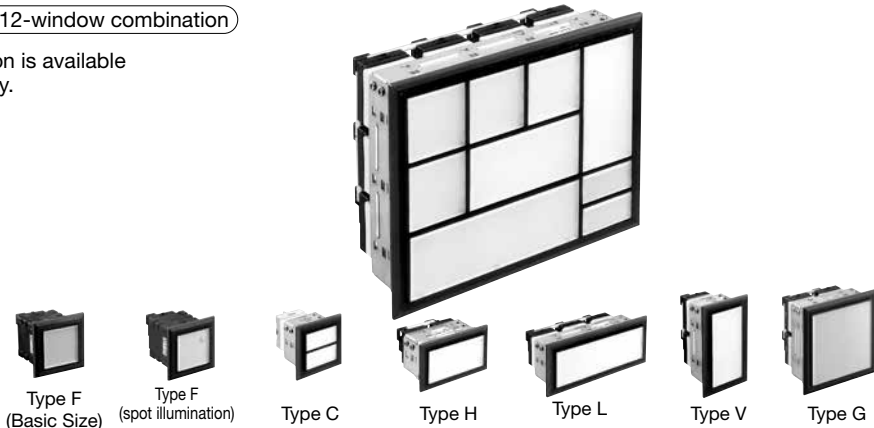
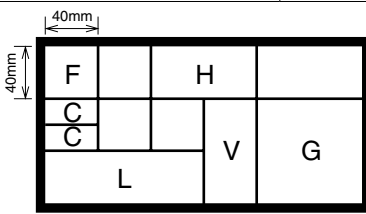
<IP65 Degree of Protection Pilot Lights>

The following control square flush pilot lights can be mounted collectively to design a panel similar to combination display lights.

SLC30 series equivalent
HW2P-1



Collective Mounting Example (HN2P)



Flange size	□30
Mounting hole	ø22
Degree of protection	IP65 (IEC 60529)

SLC30^{series} Combination Display Lights

Highly bright “Super LED” unit improves visibility and safety.

- Eight types of illumination faces to choose from. Compact combination display lights.
- Super bright Super LED.
- The fingersafe spring-up terminals reduce wiring time and prevent electrical shocks.
- The insulated jumper, when used on fingersafe spring-up terminals, eliminates the need of terminal cover.
- Legends can be engraved on the attached marking plate. One or two thin marking sheets (not attached) can also be installed (Type F only).
- Spot illumination available for easy recognition in bright environment (Type F only)
- UL and c-UL recognized, EN compliant.



1) Except for EN60947-5-1 DC-DC converter and resistor types. See website for details.

An Example of 15-window size

Spot illumination is available with type F only.

Type F Type F (spot illumination) Type C (split-window) Type H (full) / Type H2 (2-way illumination) Type L Type V Type G

- A wide variety of illumination face sizes
- Type F: 30H × 30W mm (Basic size)
 - Type F spot illumination: 30H × 30W mm
 - Type C: 15H × 30W mm × 2 (Split-window)
 - Type H: 30H × 60W mm
 - Type H2: 30H × 60W (2-way split)
 - Type L: 30H × 90W mm
 - Type V: 60H × 30W mm
 - Type G: 60H × 60W mm
- Combined construction is available.

Type F Window Spot Illumination Kit

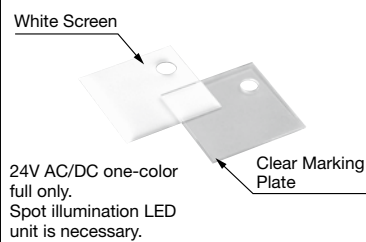

Frame (metal)

The frame cover and frame are molded in one piece for one-, two-, and three-window types.

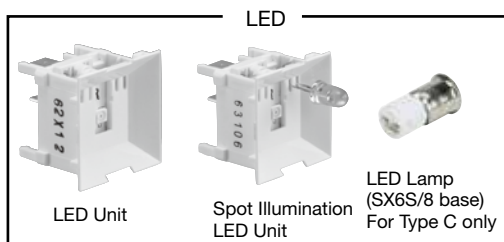

The fingersafe, spring-up terminals reduce wiring time.

The integrated terminal cover and insulated jumpers prevent electric shocks.

Application Example of Jumpers

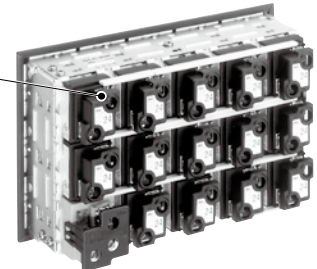

Marking films can be used for Type F only

Available up to 200 windows
10 rows by 26 columns maximum
Type F: 12, 24V AC/DC
See page 33 for details.

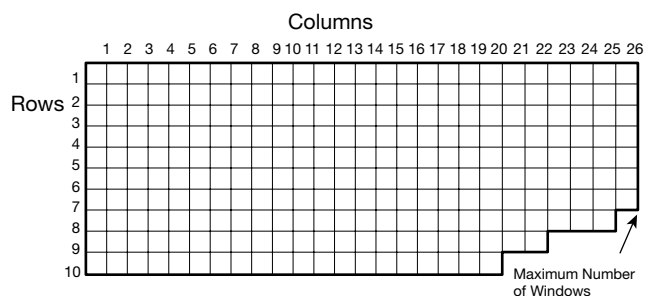

- For 110/220V AC type, up to 75 windows (Type F equivalent) can be mounted.
- For Type C, up to 50 windows (Type F equivalent) can be mounted.
- Lighting limitations should be considered in any application. For details see page 32.

Configuration

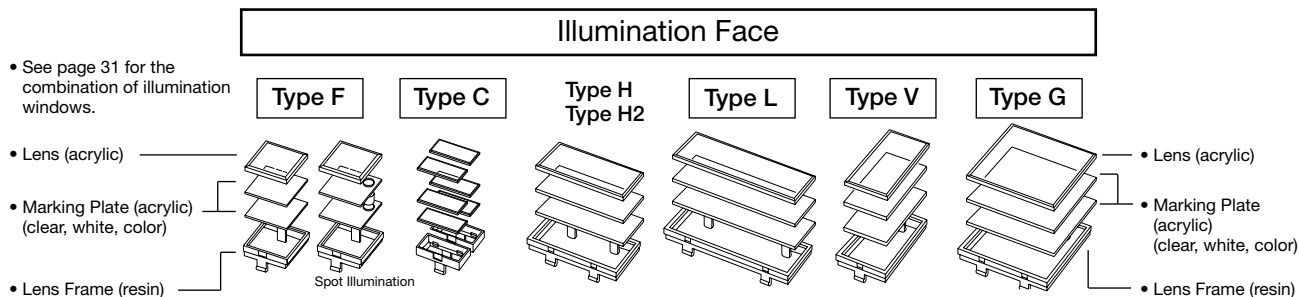

Type F, H, H2, L, V, G

Display Color Type	Light Source	Marking Plate/Color Screen (one each) (Note 2)	Lens	ON Color (Color Code)			OFF Color
Standard (using clear lens)	LED Unit	clear / white	Clear Lens	amber (A), blue (S), green (G), pure white (PW), red (R), yellow (Y), red/green 2-color alternate (RG) (Note 1)			White
Color Screen		color / white		amber (TA), blue (TS), green (TG), red (TR), yellow (TY)			Same as ON color
Gray Lens		black (Note 3) / clear	Gray Lens	Lens: gray	Legend Color	amber (SA), blue (SS), green (SG), pure white (SPW), red (SR), yellow (SY)	Gray

Note 1: Spot illumination is not available with red/green 2-color alternate (RG).
 Note 2: The order to insert clear marking plate, color screen, and white screen can be interchanged if necessary.
 Marking plate/color screen are interchangeable. Engrave markings on the flat surface of the plate or screen next to the lens.
 Note 3: Black marking plate has black coating. Engrave a reverse legend on the black-coated surface.

Type C (split-window)

Display Color Type	Light Source	Marking Plate/Color Screens (one each)(Note 4)	Lens	ON Color (Color Code)			OFF Color
Standard (using clear lens)	LED Lamp	color / white	Clear Lens	amber (A), blue (S), green (G), red (R), yellow (Y),			White
		clear / white		pure white (PW)			
Gray Lens		black (Note 5) / color	Gray Lens	Lens: gray	Legend Color	amber (SA), blue (SS), green (SG), red (SR), yellow (SY)	Gray
	black (Note 5) / clear	pure white (SPW)					

Note 4: The order to insert clear marking plate, color screen, and white screen can be interchanged if necessary.
 Marking plate/color screen are interchangeable. Engrave markings on the flat surface of the plate or screen next to the lens.
 Note 5: Black marking plate has black coating. Engrave a reverse legend on the black-coated surface.

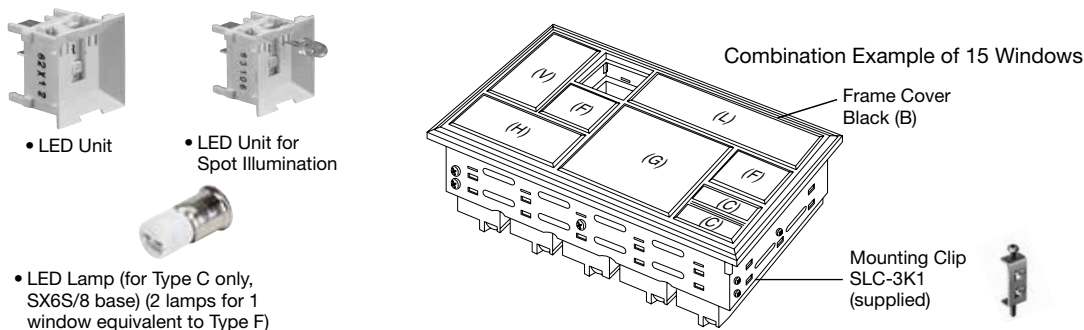

 One-color full 12, 24V AC/DC	 One-color full (w/check terminal) 24V DC (Except Type C)	 Two-color Alternate 24V AC/DC (Except Type C)
 One-color full 100/110V, 200/220V AC (Except Type C)	 One-color full 100/110V DC (Resistor Type) (Except Type C)	 One-color full 110V DC (DC-DC Converter) (Except Type C)

- 2-way split is also available in Type H2.
- The illustration above shows combination examples of windows. One-window type is available in Type F (see page 10 and 11).

Specifications

Light Source	LED Unit					LED Lamp			
Input	Full Voltage			Transformer	DC-DC Converter	Resistor	Full Voltage		
Illumination	One-color One-color w/check terminal (Note 1)		Two-color Alternate	One-color			One-color × 2 Split-window (Type C)		
Fingersafe Spring-up Terminal	Provided (except for check terminal)		(Note 2)	Provided			— (Note 2)		
Rated Voltage (AC: 50/60Hz)	12V AC/DC ±10%	24V AC/DC ±10%	24V AC/DC ±10%	100/110V AC ±10% 200/220V AC ±10%	110V DC (90 to 140V DC)	100/110V AC/DC ±10%	12V AC/DC ±10%	24V AC/DC ±10%	
Maximum Current Draw (VA)	Same as internal LED Unit			1.7	1.4	1.5	Same as internal LED		
Illumination Color	Amber, green, red, yellow	Amber, blue, green, pure white, red, yellow	Red/green Alternate	Amber, blue, green, pure white, red, yellow			Amber, blue, green, pure white (Note 6), red, yellow		
Standards	UL, c-UL listed, EN compliant				—		—		
Built-in LED Unit/Lamp	Rated Voltage	12V AC/DC	24V AC/DC	24V DC	24V AC/DC		12V AC/DC	24V AC/DC	
	Rated Current	Amber, red	12 mA	12 mA (Note 5)	Red: 12 mA Green: 11 mA	12 mA (Note 5)		4 mA	
		Green, pure white, yellow	12 mA	11 mA (Note 5)		11 mA (Note 5)			
		Blue	12 mA	11 mA (Note 5)		11 mA (Note 5)			
	Illumination Color (code)	Amber (A), blue (S), green (G), red (R), pure white (PW), yellow (Y) (Note 4)		Red (R)/green (G)	Amber (A), blue (S), green (G), pure white (PW), red (R), yellow (Y)		Amber (A), blue (S), green (G), pure white (PW), red (R)		
	Base	Plug-in unit type					SX6S/8		
	LED Life (reference)	Approx. 50,000 hours (when used on complete DC, luminance reduces to 50% of the initial intensity)							
	Part No.	SLDN-31M-*	SLDN-32M-*	SLDN-32MW-RG	SLDN-32M-*		LFTD-1*N	LFTD-2*N	
	No. of Units	1 LED unit per window of basic Type F					1 LED lamp per split-window type		
	Insulation Resistance	100 MΩ between live and dead parts (500V DC megger)							
Dielectric Strength	2000V AC (1 minute) between live and dead parts			2500V AC (1 minute) between live and dead parts		2000V AC (1 minute)	2000V AC (1 minute) between live and dead parts		
Operating Temperature (Note 3)	-20 to +40°C			-20 to +40°C	-10 to +40°C	-20 to +40°C	-20 to +40°C		
Storage Temperature	-25 to +60°C (no freezing)								
Operating Humidity	45 to 85% RH (no condensation)								

Specify a color code in place of *.

Note 1: The rated voltage for w/check terminal type is 24V DC only.

Note 2: Terminal cover is available (see page 23).

Note 3: No freezing

Note 4: Blue and pure white LED is 24V AC/DC only.

Note 5: Spot illumination uses the spot illumination LED unit (SLCN-32ST-*). See page 26 for rated current.

Note 6: Use pure white LED lamp for yellow (Y) illumination.

Illumination Face		Type F (Note 7) (Basic)	Type C (Split-window)	Type H / Type H2 (Note 9)	Type L	Type V	Type G
Illumination Unit Size (mm)	Window (H × W)	30 × 30	15 × 30	30 × 60	30 × 90	60 × 30	60 × 60
	Illumination Face (H × W)	28 × 28	13 × 28	28 × 58	28 × 88	58 × 28	58 × 58
	White color screen, clear marking plate, color screen (H × W × t)	27 × 27 × 1.0 (Note 8)	12 × 27 × 1.0	27 × 57 × 1.0 (Note 9)	27 × 87 × 1.0	57 × 27 × 1.0	57 × 57 × 1.0
	Marking Film	Applicable	—	—	—	—	—
	Engraving Area (white, transparent, color plates)	25 × 25	10 × 25	25 × 55 (Note 9)	25 × 85	55 × 25	55 × 55
Material of Marking Plate & Color Screen	Acrylic						
Lens Frame Color & Frame Cover Color	Black (Munsell N1.5 equivalent)						
Connection Wire	Solid wire: ø1.6 × 2, Stranded 2 mm ² × 2						
Terminal Screw	M3.5 screw, Check terminal: M3						
Degree of Protection	IP40 (IEC 60529)						
Pollution Degree	3						

• Spot illumination uses designated clear plate and color screen.

Note 7: Pure white illumination and spot illumination types are available in Type F only.

Note 8: Spot illumination type uses an exclusive clear marking plate and color screen.

Note 9: 2-way split type (Type H2) can use 2-way split color screen only.

Dimensions

[Front View] a: No. of Rows b: No. of Columns

Type F

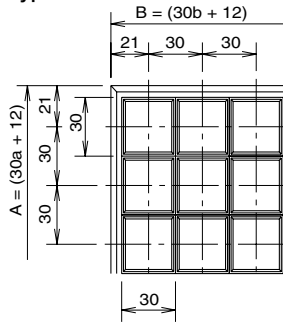

Type F (Spot Illumination)

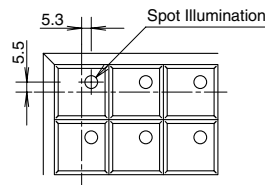

Type H

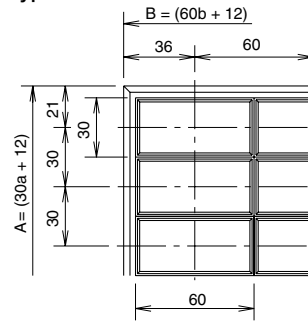

Type H2 (2-way split)

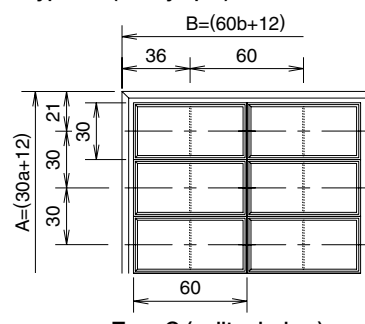

Type V

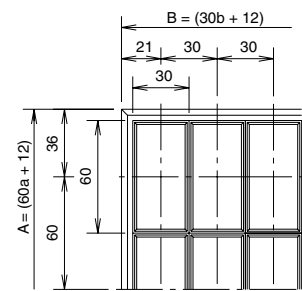

Type L

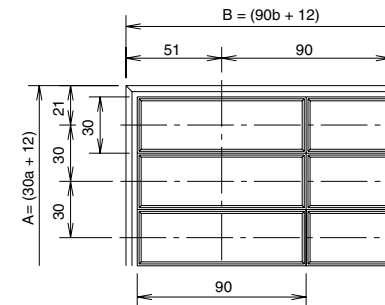

Type G

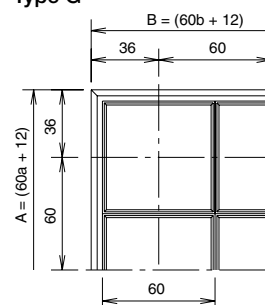

Type C (split-window)

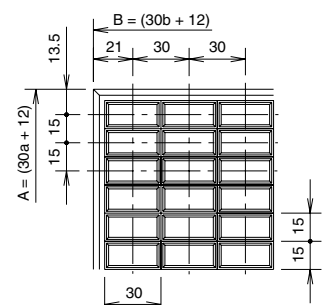

All dimensions in mm.

Type F Dimensions & No. of Windows (Type C, H, L, V, and G can be converted into Type F)

	Columns	b	01	02	03	04	05	06	07	08	09	10	11	12	13	14	15	16	17	18	19	20	21	22	23	24	25	26
Rows	Dimensions	B	42	72	102	132	162	192	222	252	282	312	342	372	402	432	462	492	522	552	582	612	642	672	702	732	762	792
	Panel Cut-out (D)	(D)	(35)	(65)	(95)	(125)	(155)	(185)	(215)	(245)	(275)	(305)	(335)	(365)	(395)	(425)	(455)	(485)	(515)	(545)	(575)	(605)	(635)	(665)	(695)	(725)	(755)	(785)
a	A	A	(35)	(65)	(95)	(125)	(155)	(185)	(215)	(245)	(275)	(305)	(335)	(365)	(395)	(425)	(455)	(485)	(515)	(545)	(575)	(605)	(635)	(665)	(695)	(725)	(755)	(785)
01	42	(35)	1	2	3	4	5	6	7	8	9	10	11	12	13	14	15	16	17	18	19	20	21	22	23	24	25	26
02	72	(65)	2	4	6	8	10	12	14	16	18	20	22	24	26	28	30	32	34	36	38	40	42	44	46	48	50	52
03	102	(95)	3	6	9	12	15	18	21	24	27	30	33	36	39	42	45	48	51	54	57	60	63	66	69	72	75	78
04	132	(125)	4	8	12	16	20	24	28	32	36	40	44	48	52	56	60	64	68	72	76	80	84	88	92	96	100	104
05	162	(155)	5	10	15	20	25	30	35	40	45	50	55	60	65	70	75	80	85	90	95	100	105	110	115	120	125	130
06	192	(185)	6	12	18	24	30	36	42	48	54	60	66	72	78	84	90	96	102	108	114	120	126	132	138	144	150	156
07	222	(215)	7	14	21	28	35	42	49	56	63	70	77	84	91	98	105	112	119	126	133	140	147	154	161	168	175	182
08	252	(245)	8	16	24	32	40	48	56	64	72	80	88	96	104	112	120	128	136	144	152	160	168	176	184	192	200	—
09	282	(275)	9	18	27	36	45	54	63	72	81	90	99	108	117	126	135	144	153	162	171	180	189	198	—	—	—	—
10	312	(305)	10	20	30	40	50	60	70	80	90	100	110	120	130	140	150	160	170	180	190	200	—	—	—	—	—	—

How to Read the Table

- The number of windows equals rows multiplied by columns. For example, for 5 rows by 7 columns, the number of windows is 35, external dimensions are 162mm high by 222mm wide, and panel cut-out is 155mm high by 215mm wide.
- External dimensions are represented by A for rows and B for columns in boldface.
- Panel cut-out dimensions are shown in (), for height (C) and width (D). Panel cut-out tolerance is +1.0 to -0.4mm (for one window: +0.6 to -0.4mm).

[Example]

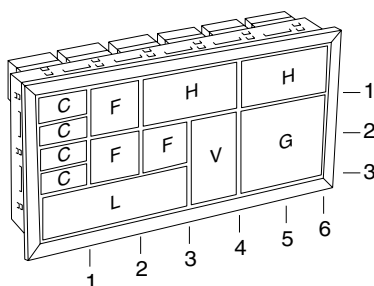

- Total number of windows, dimensions, panel cut-out
 - For Type C, H, L, V, and G, convert the numbers of rows and columns into Type F (basic size) equivalents.
 - Type C — Type F equivalent: 2 split-windows consist of one window.
 - Type H — Type F equivalent: 2 windows. Height: 1 row. Width: 2 columns.
 - Type V — Type F equivalent: 2 windows. Height: 2 rows. Width: 1 column.

Panel Cut-out (SLC30)

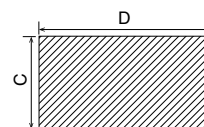

Determine the panel thickness in consideration of the weight of display lights and wires (see page 23).

- Type L — Type F equivalent: 3 windows. Height: 1 row. Width: 3 columns.
- Type G — Type F equivalent: 4 windows. Height: 2 rows. Width: 2 columns.

- The combination example at left consists of 3 rows by 6 columns.
- The above table shows: No. of windows: 18. Dimensions: 102H x 192W mm. Panel cut-out: 95H x 185W mm.

Dimensions

[Side & Rear Views]

Type F (Type H, L, V, and G are the same in side and rear views as Type F.)

- Full Voltage
- 12, 24V AC/DC
- One-color full
- Spot Illumination 24V AC/DC

- Full Voltage
- One-color full w/Check Terminal 24V DC
- Two-color alternate 24V AC/DC
- For applicable terminal cover, see page 23.

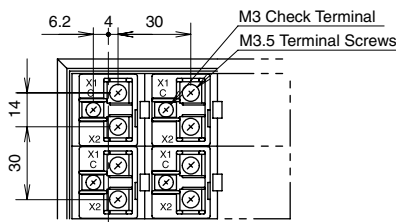
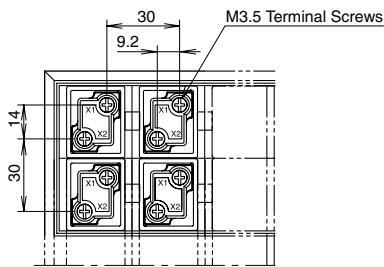
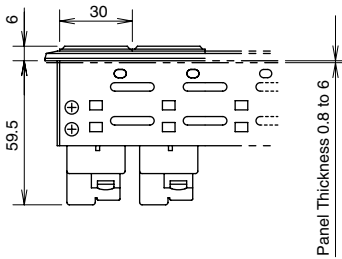
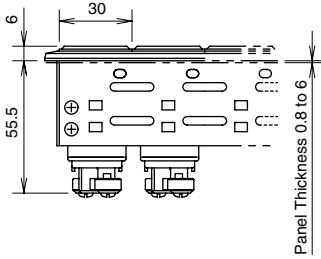

- w/Check Terminal
Terminal X1 is a positive pole; Terminal X2 and C (check terminal) are negative poles.
- Two-color Alternate
Red (R) illumination: X1 positive, C negative
Green (G) illumination: X1 positive, X2 negative

- Transformer
- One-color full
- 100/110, 200/220V AC/DC
- 110VDC (DC-DC Converter)

- Resistor
- One-color full
- 100/110V AC/DC

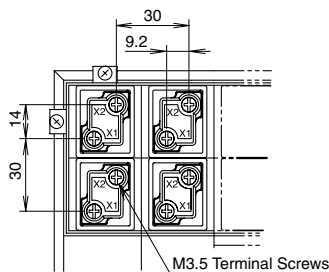
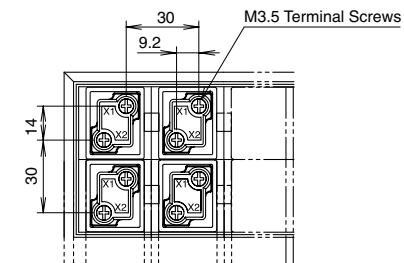
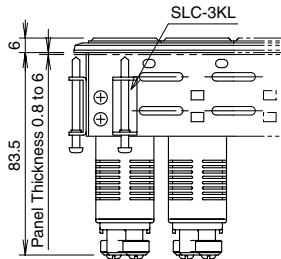
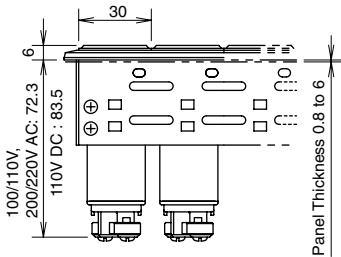

- On DC-DC converter type units, Terminals X1 and X2 are positive and negative poles, respectively.

Type C (split-window)

- Full Voltage
- 12, 24V AC/DC
- One-color full, 2 x LED lamps, Split-window type

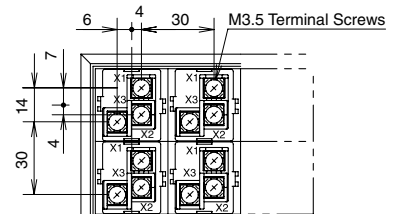
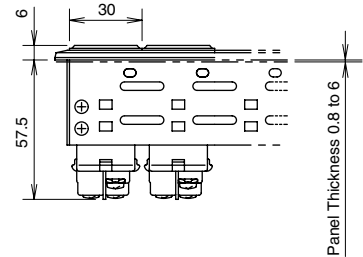

- Terminal X1 is COM terminal.
- For applicable terminal cover, see page 23.

All dimensions in mm.

Dimensions

[One-window, Type F only]
Full Voltage 12, 24V AC/DC, One-color Full

All dimensions in mm.

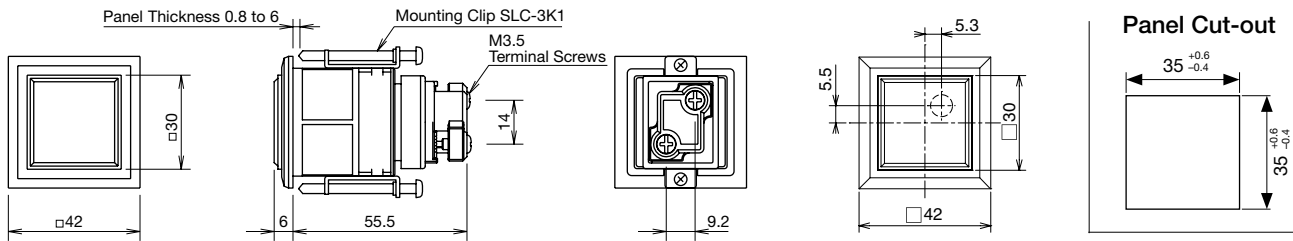

Full Voltage w/Check Terminal 24V DC / Two-color Alternate 24V AC/DC

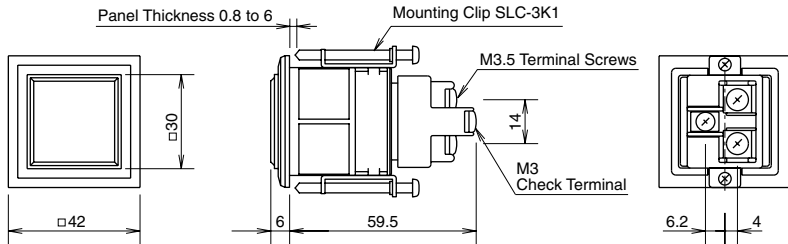

- w/Check Terminal Type
Terminal X1 is a positive pole; Terminals X2 and C (check terminal) are negative poles.
- Two-color Alternate Type
Red (R) illumination: X1 positive, C negative
Green (G) illumination: X1 positive, X2 negative
- See page 23 for terminal covers.

Transformer 100/110, 200/220V AC

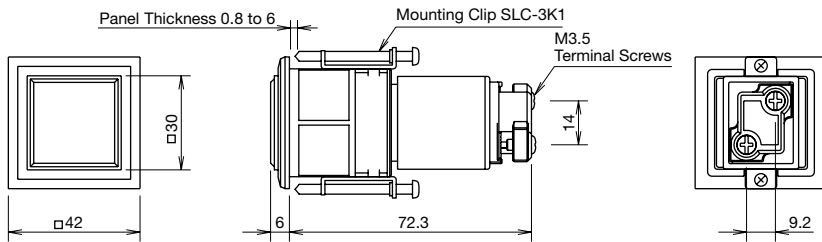

DC-DC Converter 110V DC

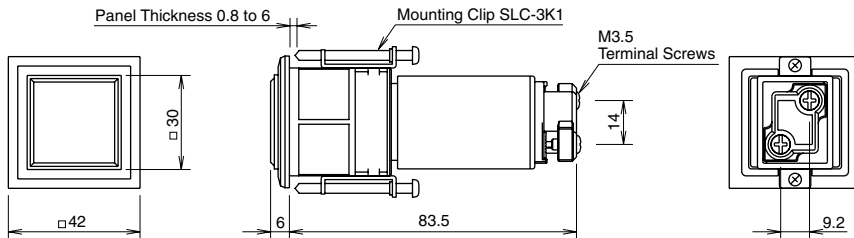

- On DC-DC converter type, Terminals X1 and X2 are positive and negative poles, respectively.

Resistor 100/110V AC/DC

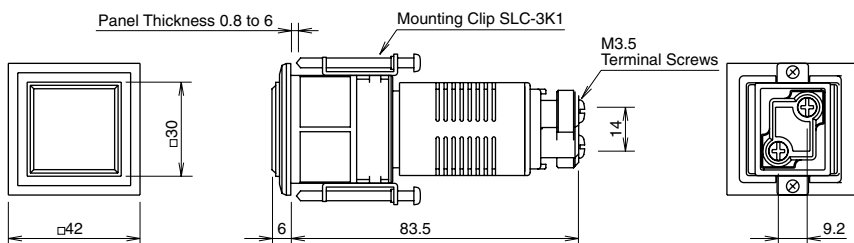

(Resistance)
7.2 kΩ, 4W

Terminal Connection

- For one-color full with check terminal, DC-DC converter, and resistor, Terminals X1 and X2 are positive and negative poles, respectively.

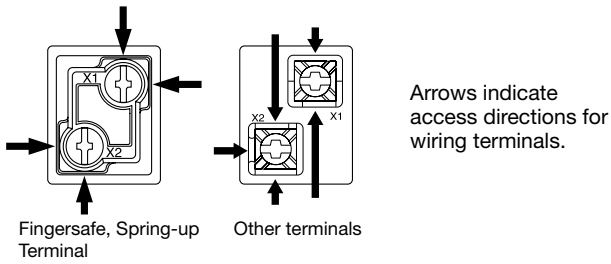

- For w/check terminal and two-color alternate units, terminal X1 is a positive pole; Terminals X2 and C (check terminal) are negative poles.

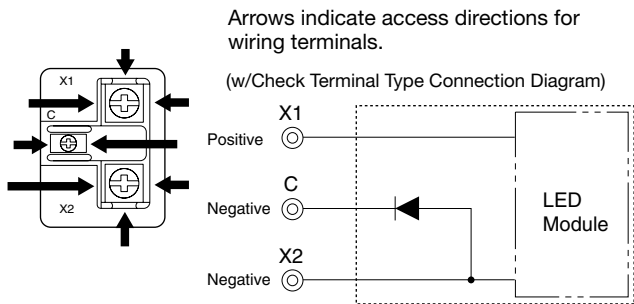

- Connection for two-color alternate is as follows.
 Red (R) — Terminal X1: positive, Terminal C: negative
 Green (G) — Terminal X1: positive, Terminal X2: negative
 (Two-color alternate Type Connection Diagram)

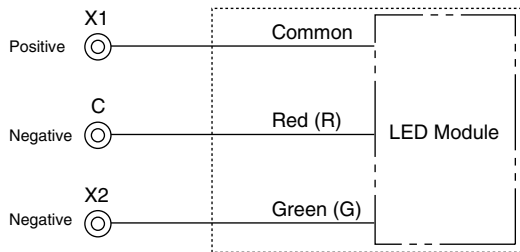

- For the split-window (Type C), Terminal X1 (+) is a common terminal. Terminal X2 is a negative pole of upper illumination and Terminal X3 is a negative pole of lower illumination. (AC/DC)

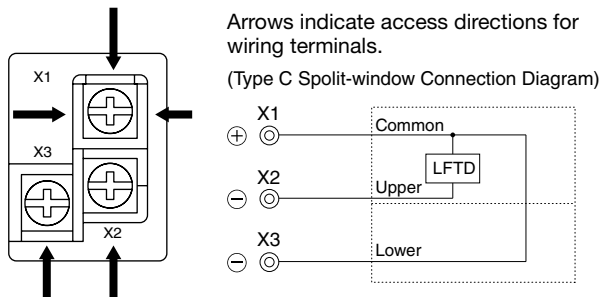

Terminal Connection Using Jumpers

- For terminal connection of types F, H, L, V, and G (except Type C), jumpers can be used as shown below.

SLC30 Series

	Terminal X1	Terminal X2	Terminal C
Fingersafe, Spring-up Terminal (Note 1)	SLCN-JP34 SLCN-JP35	SLCN-JP34 SLCN-JP35	—
Others	SLC-JP30	SLC-JP33	SLC-JP32

Note 1: Fingersafe, spring-up terminals are used in one-color full illuminated type (12, 24V AC/DC, 100/110, 200/220V AC, 110V DC).

- For Type C, jumpers can be used on Terminal X1 only as shown below.

Direction	<ul style="list-style-type: none"> When using Type C only When using Type C and Two-color alternate
Vertical	SLC-JP33
Horizontal	SLC-JP30

Note: Jumpers cannot be used when using both Type C and fingersafe spring-up terminals.

[Examples of Using Jumpers]

Fingersafe Spring-up Terminal)

When connecting two windows

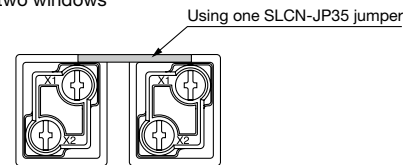

When connecting three windows

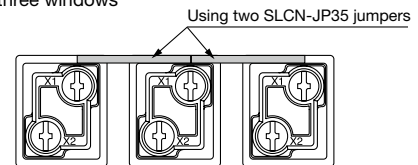

When connecting four windows

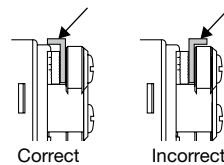
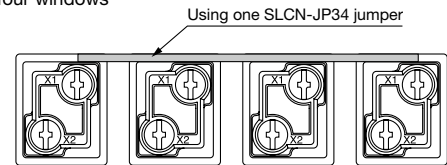

Jumpers (SLCN-JP34/35) have an orientation. Ensure that jumpers are installed correctly.

Part No. Development

SLC30N - 0405 - DD2FB - Example: A (10), G (5), R (5)
Specify the color code and the number of windows.

30 Series

When ordering Type H, L, V, G, or C units, enter the equivalents of Type F.

Frame Color
Black: B

Equivalent of Basic Size Windows		Unit (Code)		Operating Voltage (Built-in Lamp) (Code)		Illumination Face Size (Code)		Illumination Color		
Rows	Columns									
01	01	LED Unit	Full Voltage (A, G, R, Y)	DD	12V AC/DC ±10%	1	Type F 30 × 30 mm	F	Standard Clear Lens Combination (Code)	
02	02		24V AC/DC ±10%	2	Type H 30 × 60 mm	H				Amber
03	03		Full Voltage (PW, S)	DDA			24V AC/DC ±10%	2	Type H2 (Note 1) (2-way split) 30 × 60 mm	H2
04	04		Full Voltage / Type H2 only (Combination of S and A, G, R, Y)	DDC	24V AC/DC ±10%	2	Type L 30 × 90 mm	L		
05	05		Full Voltage w/Check Terminal (A, G, R, Y)	DHM	24V DC ±10%	2			Type V 60 × 30 mm	V
06	06		Full Voltage Two-color Alternate (R/G)	DW	24V AC/DC ±10%	2	Type V 60 × 60 mm	G		
07	07		Transformer (A, G, R, Y)	TD	100/110V AC ±10%	1			Type C (15 × 30 mm) × 2	C
08	08		Transformer (PW, S)	TDA	200/220V AC ±10%	2	Type F Spot Illumination 30 × 30 mm	FST		
09	09		Transformer / Type H2 only (Combination of S and A, G, R, Y)	TDC	100/110V AC ±10%	1			A light barrier, clear marking plate, and color screen for 2-way split illumination are supplied.	
10	10		DC-DC Converter (A, G, R, Y)	CD	200/220V AC ±10%	2	When color display is required at power off, order color screens. For details, see page 31.			
11	11	LED Lamp	One-color Full × 2 split window (Type C) (A, G, R, Y)	SX6S/8 Base	DP	12V AC/DC ±10% (LFTD-1*N)	1	L	Green	TG
12	12					24V AC/DC ±10% (LFTD-2*N)	2		Red	TR
13	13	The following color/voltage selections are also available.								
14	14	LED Unit	Full Voltage w/Check Terminal (PW, S)	DHMA	110V DC (90 to 140V DC)	1	Type V 60 × 30 mm	V	Gray Lens Combination (Code)	
15	15		Resistor (A, G, R, Y)	RN	100/110V AC/DC ±10%	1				Type V 60 × 60 mm
16	16		One-color Full × 2 split window (Type C) (combination of PW, S only)	DPA	12V AC/DC ±10% (LFTD-1*N) × 2	1	Type V 60 × 60 mm	G	Green	
17	17		24V AC/DC ±10% (LFTD-2*N) × 2	2	Type C (15 × 30 mm) × 2	C			Pure White	SPW
18	18		Transformer (A, G, R, Y)	TD			115/120V AC ±10%	12	Type F Spot Illumination 30 × 30 mm	FST
19	19		Transformer (PW, S)	TDA	230/240V AC ±10%	24	Type C (15 × 30 mm) × 2	C		
20	20		Transformer / Type H2 only (Combination of S and A, G, R, Y)	TDC	115/120V AC ±10%	12			Type C (15 × 30 mm) × 2	C
21	21		DC-DC Converter (PW, S)	CDA	110V DC (90 to 140V DC)	1	Type L, V, and G cannot be split-illuminated. Enter the required number of color screens in ().			
22	22		Resistor (PW, S)	RNA	100/110V AC/DC ±10%	1				
23	23		LED Lamp	One-color Full × 2 split window (Type C) (combination of PW, S and A, G, R, Y)	SX6S/8 Base	DPC	12V AC/DC ±10% (LFTD-1*N)	1		
24	24	24V AC/DC ±10% (LFTD-2*N)					2			

Note 1: Type H2 (2-way split) can be configured with the combination described below.

Left	Right
Standard Clear Lens	Standard Clear Lens
Color Screen	Color Screen
Grey Lens	Grey Lens

Ordering Information

When ordering SLC Series Combination Display Lights, use the specification sheet provided on page 36.

Designation Procedure

- Part No.: Refer to Part No. Development Configuration on page 12.
- Quantity: Enter the required number of identical assemblies.

Counting of Windows

Count the number of windows in the equivalent of Type F (basic size).

Leaf Spring (for one-window type only)

Leaf spring for temporary fastening is not attached, and can be supplied free of charge upon request when ordering (Part No. SLD44KVP).

[Conversion Rate]

- Type H (horizontal)
 - Type F equivalent: 2 windows
 - Row (1), Column (2)
- Type L (horizontal)
 - Type F equivalent: 3 windows
 - Row (1), Column (3)
- Type V (vertical)
 - Type F equivalent: 2 windows
 - Row (2), Column (1)
- Type G (large)
 - Type F equivalent: 4 windows
 - Row (2), Column (2)
- Type C (split-window)
 - Type F equivalent: 1 window
 - Row (1), Column (1)

[Designation Examples]

Ex. 1 SLC30 Series
Type F, 20 windows

SLC30N-04 05 [] [] F []

Columns

Rows

Ex. 2 SLC30 Series
Type H, 9 windows (Type F equivalent: 3 rows by 6 columns)

SLC30N-03 06 [] [] H []

Columns

Rows

Ex. 3 SLC30 Series (Type F, 12 windows)

When ordering a combination of units with different operating voltages, specify Part No. as follows.

Type F, 12 windows, Full voltage type 24V AC/DC 8 Transformer Type 100/110V AC 4

SLC30N-0304-DD 2 FB(8) + TD 1 FB(4) - R(12)

Specify the position of the units and each voltage on the specification sheet.

Ex. 4 When ordering a combination of units with different illumination colors, specify Part No. as follows.

Example: Full voltage 24V AC/DC, Red (6), Pure White (2)

SLC30N-0204-DD2FB(6) + DDA2FB(2) - R(6)PW(2)

Red Pure White Designation

Red: 6, Pure White: 2

Ex. 5 When ordering a combination of units with different illumination colors for four windows of type C, specify Part No. as follows.

Example: Full voltage 24V AC/DC

SLC30N-0202-DPA2CB(1) DPC2CB(3) - R(1)G(1)A(1)S(1)PW(4)

Blue, Pure white Red, green, amber, pure white Designation

Red: 1, green: 1, blue 1, amber 1, pure white 4

Units in one color

R (20)

(Color screen: Type F, 20 windows)
R (20) = 20

• When color screen is required, specify the color screen code.

Ex. T * Color Code Color Screen Code

No entry is required in designations.

Specify each color code on the specification sheet.

Columns	1	2	3	4	5	6	
Rows	1	R	R	R	R	R	+
	2	G	G	G	G	G	+
	3	Y	Y	Y	Y	Y	+
	4	A	A	A	A	A	+
	5	+	+	+	+	+	+
	~						

R (9)

(Color screen: Type H, 9 windows)
R (9) = 9

• When color screen is required, specify the color screen code.

Ex. T * Color Code Color Screen Code

No entry is required in designations.

Specify each color code on the specification sheet.

Columns	1	2	3	4	5	6	7	
Rows	1	PW	R	R				+
	2	PW	R	R				+
	3	PW	G	G				+
	4	+	+	+	+	+	+	+
	~							

DD2

TD1

SLC40 Series Combination Display Lights

Highly bright “Super LED” unit improves visibility and safety.

- Eight types of illumination faces in 40mm size.
- Extensible window ensures high visibility when installed at high places (except C, L, G).
- Super bright Super LED.
- The fingersafe spring-up terminals save wiring time and prevent electrical shocks.
- The insulated jumper, when used on fingersafe spring-up terminals, eliminates the need of terminal cover.
- Legends can be engraved on the attached marking plate. One or two thin marking sheets (not attached) can also be installed (Type F only).
- Spot illumination available for easy recognition in bright environment (Type F only).
- UL and c-UL recognized, EN compliant



1) Except for EN60947-5-1 DC-DC converter and resistor types. See website for details.

An Example of 12-window size

Spot illumination is available with type F only.

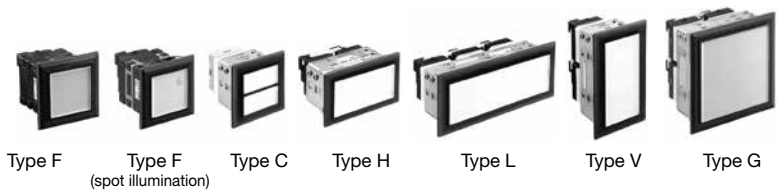

- A wide variety of illumination face sizes
- Type F: 40H × 40W mm (Basic size)
 - Type F spot illumination: 40H × 40W mm
 - Type C: 20H × 40W mm × 2 (Split-window type)
 - Type H: 40H × 80W mm
 - Type L: 40H × 120W mm
 - Type V: 80H × 40W mm
 - Type G: 80H × 80W mm
- Combined construction is available.

Extensible windows
Easy to recognize at high places (except Type C, L, and G)

The Fingersafe Spring-up terminals reduce wiring time. The integrated terminal cover and insulated jumpers prevent electric shocks.

Application Example of Jumpers

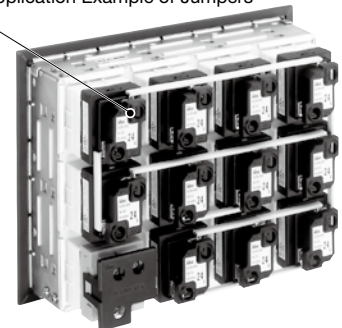

Type F Window Spot Illumination Kit

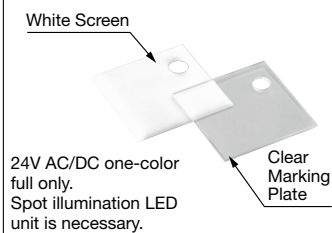

Frame (metal)
The frame cover and frame are integrated and molded of resin for Type F, one-window type.



Split-window reduces installation space.

Available up to 126 windows
LED: 7 rows by 24 columns
LED illumination: 24V AC/DC
See page 33 for details.

LED illumination

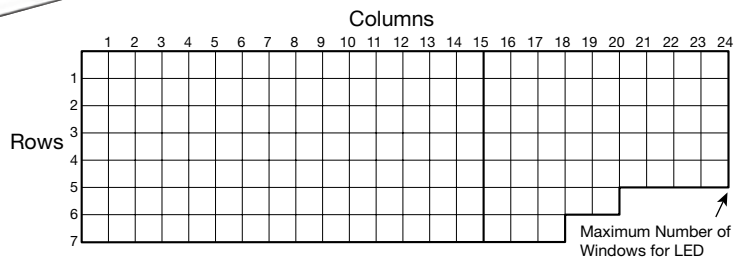

- For 110/220V AC type, up to 60 windows (Type F equivalent) can be mounted.
- For Type C, up to 105 windows (Type F equivalent) can be mounted.
- Lighting limitations should be considered in any applications. For details, see page 29.

Configuration

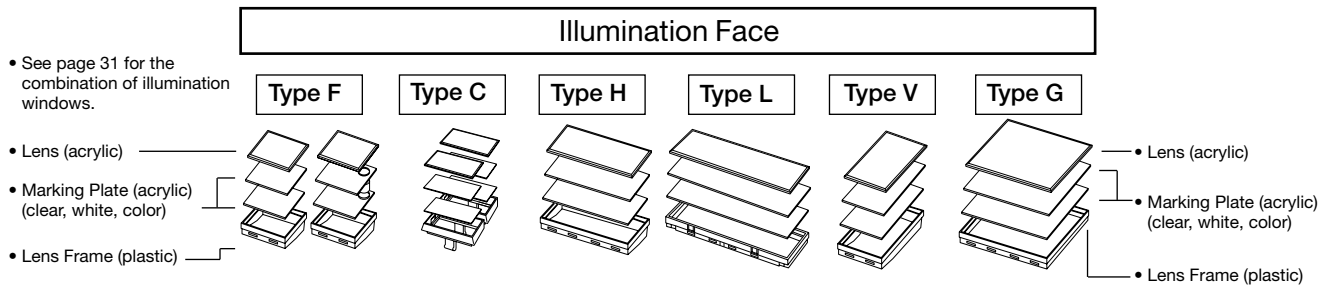

Type F, H, L, V, G

Display Color Type	Light Source	Marking Plate/Color Screen (one each) (Note 1) (Note 2)	Lens	ON Color (Color Code)		OFF Color
Standard (using clear lens)	LED Unit	clear / white	Clear Lens	amber (A), blue (S), green (G), pure white (PW), red (R), yellow (Y), red/green 2-color alternate (RG) (Note 1)		White
Color Screen		color / white		amber (TA), blue (TS), green (TG), red (TR), yellow (TY)		Same as ON color
Gray Lens		black (Note 3) / clear	Gray Lens	Lens: gray	Legend Color	amber (SA), blue (SS), green (SG), pure white (SPW), red (SR), yellow (SY)

Note 1: Spot illumination is not available with red/green 2-color alternate (RG).

Note 2: The order to insert clear marking plate, color screen, and white screen can be interchanged if necessary. Marking plate/color screen are interchangeable. Engrave markings on the flat surface of the plate or screen next to the lens.

Note 3: Black marking plate has black coating. Engrave a reverse legend on the black-coated surface.

Type C (split-window)

Display Color Type	Light Source	Marking Plate/Color Screen (one each) (Note 4)	Lens	ON Color (Color Code)		OFF Color	
Standard (using clear lens)	LED Lamp	color / white	Clear Lens	amber (A), blue (S), green (G), red (R), yellow (Y)		White	
		clear / white		pure white (PW)			
Gray Lens		black (Note 5) / color	Gray Lens	Lens: gray	Legend Color	amber (SA), blue (SS), green (SG), red (SR), yellow (SY)	Gray
		black (Note 5) / clear		pure white (SPW)			

Note 4: The order to insert clear marking plate, color screen, and white screen can be interchanged if necessary.

Marking plate/color screen are interchangeable. Engrave markings on the flat surface of the plate or screen next to the lens.

Note 5: Black marking plate has black coating. Engrave a reverse legend on the black-coated surface.

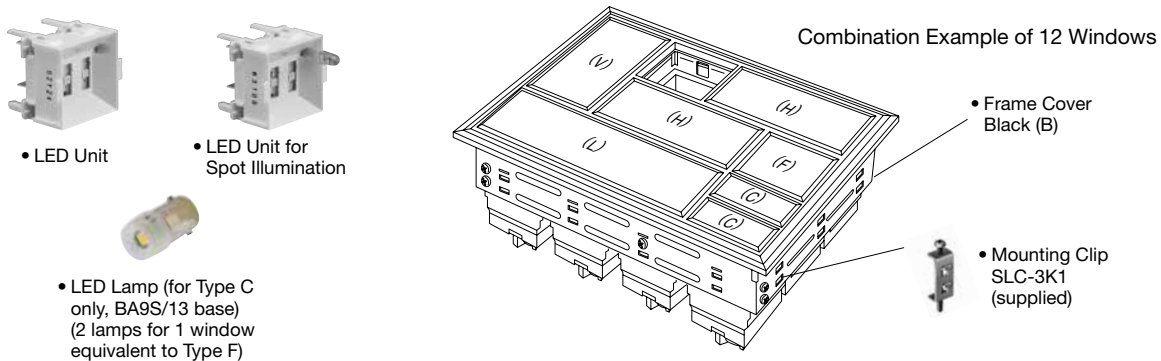

<p>One-color full</p> <p>24V AC/DC</p>	<p>One-color full (w/check terminal)</p> <p>24V DC (Except Type C)</p>	<p>Two-color Alternate</p> <p>24V AC/DC (Except Type C)</p>
<p>One-color full</p> <p>100/110V, 200/220V AC (Except Type C)</p>	<p>One-color full</p> <p>100/110V DC (Resistor Type) (Except Type C)</p>	<p>One-color full</p> <p>110V DC (DC-DC Converter) (Except Type C)</p>

• The illustration above shows combination examples of windows. One-window is available in Type F.

Specifications

Light Source	LED Unit					LED Lamp	
Input	Full Voltage		Transformer	DC-DC Converter	Resistor	Full Voltage	
Illumination	One-color One-color w/check terminal (Note 1)	Two-color Alternate	One-color	One-color	One-color	One-color × 2 Split-window Type (Type C)	
Fingersafe Spring-up Terminal	Provided (except for check terminal)	(Note 2)	Provided			— (Note 2)	
Rated Voltage (AC: 50/60Hz)	24V AC/DC ±10%	24V AC/DC ±10%	100/110V AC ±10% 200/220V AC ±10%	110V DC (90 to 140V DC)	100/110V AC/DC ±10%	24V AC/DC ±10%	
Maximum Current Draw (VA)	Same as internal LED unit		4.7	1.8	2.4	Same as internal LED lamp	
Illumination Color	Amber, blue, green, pure white, red, yellow	Red/green Alternate	Amber, blue, green, pure white, red, yellow			Amber, blue, green, pure white, red, yellow	
Standards	UL, c-UL listed, EN compliant			—		—	
Built-in LED Unit/Lamp	Rated Voltage	24V AC/DC	24V AC/DC	24V AC/DC		24V AC/DC	
	Rated Current (Note 5)	Amber	15 mA (Note 4)	Red: 15 mA Green: 15 mA	15 mA		7 mA
		Blue					
		Pure White					
		Green					
		Red					
	Yellow						
	Illumination Color (code)	Amber (A), blue (S), green (G), pure white (PW), red (R), yellow (Y)	Red (R)/green (G)	Amber (A), blue (S), green (G), pure white (PW), red (R), yellow (Y)			Amber (A), blue (S), green (G), pure white (PW), red (R), Y (yellow)
	LED Life (reference)	Approx. 50,000 hours (when used on complete DC, luminance reduces to 50% of the initial intensity)					
	Base	Plug-in unit type (for SLC40 only)				BA9S/13 base	
Part No.	SLCN-42M-*	SLCN-42MW-RG	SLCN-42M-*		LSRD-2		
No. of Units	1 LED unit per window of basic Type F				1 LED lamp per window of basic Type F		
Insulation Resistance	100 MΩ (500V DC megger)						
Dielectric Strength	2000V AC (1 minute) between live and dead parts		2500V AC (1 minute) between live and dead parts		2000V AC (1 minute)	2000V AC (1 minute) between live and dead parts	
Operating Temperature (Note 3)	-20 to +40°C		-20 to +40°C	-10 to +40°C	-20 to +40°C	-20 to +40°C	
Storage Temperature	-25 to +60°C (no freezing)						
Operating Humidity	45 to 85% RH (no condensation)						

Specify a color code in place of *.

Note 1: The rated voltage for w/check terminal is 24V DC only.

Note 2: Terminal cover is available (see page 23).

Note 3: No freezing

Note 4: Spot illumination uses the spot illumination LED unit (SLCN-42ST-*). See page 26 for rated current.

Note 5: Rated current for LED lamp is for DC. See page 26 for AC.

Illumination Face		Type F (Note 6) (Basic)	Type C (Split-window)	Type H	Type L	Type V	Type G
Illumination Unit Size (mm)	Window (H × W)	40 × 40	20 × 40	40 × 80	40 × 120	80 × 40	80 × 80
	Illumination Face (H × W)	37 × 37	17 × 37	37 × 77	37 × 117	77 × 37	77 × 77
	White color screen, clear marking plate, color screen (H × W × t)	35.8 × 35.8 × 1.0	15.8 × 35.8 × 1.0	35.8 × 75.8 × 1.0	35.8 × 115.8 × 1.0	75.8 × 35.8 × 1.0	75.8 × 75.8 × 1.0
	Marking Film	Applicable	—	—	—	—	—
	Engraving Area (white, transparent, color plates)	34 × 34	14 × 34	34 × 74	34 × 114	74 × 34	74 × 74
Material of Marking Plate & Color Screen	Acrylic						
Lens Frame Color & Frame Cover Color	Black (Munsell N1.5 equivalent)						
Connection Wire	Solid wire: ø1.6 × 2, Stranded 2 mm ² × 2						
Terminal Screw	M3.5 screw, Check terminal: M3						
Degree of Protection	IP40 (IEC60529)						
Pollution Degree	3						

Note 6: One-window and spot illumination are available in Type F only.

Dimensions

[Front View] a: No. of Rows b: No. of Columns

Type F

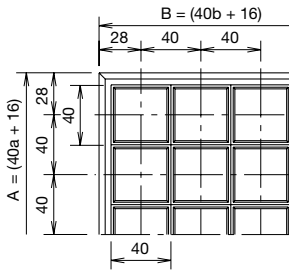

Type F (Spot Illumination)

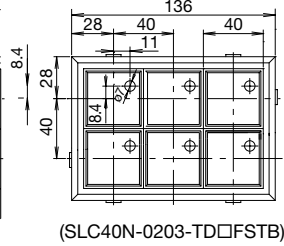

Type H

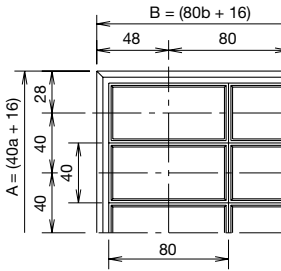

Type V

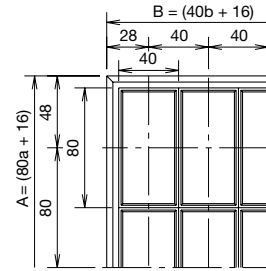

Type L

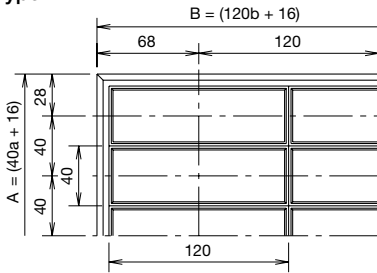

Type G

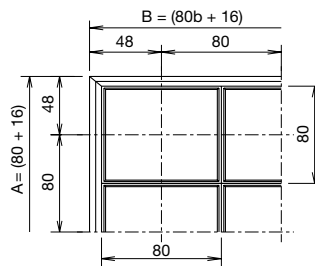

Type C

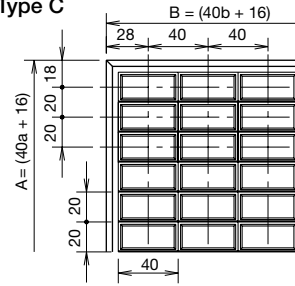

All dimensions in mm.

Type F Dimensions & No. of Windows (Type C, H, L, V, and G can be converted into Type F)

	Columns	b	01	02	03	04	05	06	07	08	09	10	11	12	13	14	15	16	17	18	19	20	21	22	23	24
Rows	Dimensions	B	56	96	136	176	216	256	296	336	376	416	456	496	536	576	616	656	696	736	776	816	856	896	936	976
a	A	Panel Cut-out (C) (D)	(45)	(85)	(125)	(165)	(205)	(245)	(285)	(325)	(365)	(405)	(445)	(485)	(525)	(565)	(605)	(645)	(685)	(725)	(765)	(805)	(845)	(885)	(925)	(965)
01	56	(45)	1	2	3	4	5	6	7	8	9	10	11	12	13	14	15	16	17	18	19	20	21	22	23	24
02	96	(85)	2	4	6	8	10	12	14	16	18	20	22	24	26	28	30	32	34	36	38	40	42	44	46	48
03	136	(125)	3	6	9	12	15	18	21	24	27	30	33	36	39	42	45	48	51	54	57	60	63	66	69	72
04	176	(165)	4	8	12	16	20	24	28	32	36	40	44	48	52	56	60	64	68	72	76	80	84	88	92	96
05	216	(205)	5	10	15	20	25	30	35	40	45	50	55	60	65	70	75	80	85	90	95	100	105	110	115	120
06	256	(245)	6	12	18	24	30	36	42	48	54	60	66	72	78	84	90	96	102	108	114	120	—	—	—	—
07	296	(285)	7	14	21	28	35	42	49	56	63	70	77	84	91	98	105	112	119	126	—	—	—	—	—	—

How to Read the Table

- The number of windows equals rows multiplied by columns. For example, for 5 rows by 7 columns, the number of windows is 35, external dimensions are 216mm high by 296mm wide, and panel cut-out is 205mm high by 285mm wide.
- External dimensions are represented by A for rows and B for columns in boldface.
- Panel cut-out dimensions are shown in (), for height (C) and width (D). Panel cut-out tolerance is +1.0 to -0 mm (for one window: +0.6 to -0.4mm).

Panel Cut-out (SLC40)

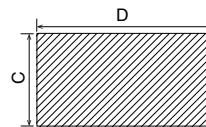

Determine the panel thickness in consideration of the weight of display lights and wires (see page 23).

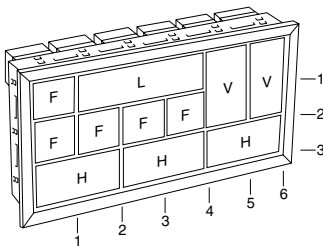

- Total number of windows, dimensions, panel cut-out
 - For Type C, H, L, V, and G, convert the numbers of rows and columns into Type F (basic size) equivalents.
 - Type C — Type F equivalent: 2 split-windows consist of one window.
 - Type H — Type F equivalent: 2 windows
 - Type V — Type F equivalent: 2 windows.

- Type L — Type F equivalent: 3 windows

 Height: 1 row
Width: 3 columns
- Type G — Type F equivalent: 4 windows

 Height: 2 rows
Width: 2 columns

- The combination example at left consists of 3 rows by 6 columns.
- The above table shows: No. of windows: 18
Dimensions: 136H x 256W mm
Panel cut-out: 125H x 245W mm

Dimensions

[Side & Rear Views]

- Full Voltage
- 24V AC/DC
- One-color full
- For applicable terminal cover, see page 23.
- Spot illumination 24V AC/DC

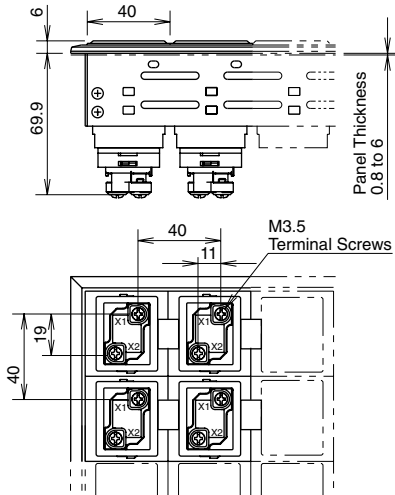

- Full Voltage
- One-color full
- w/Check Terminal 24V DC
- Two-color alternate 24V AC/DC
- For applicable terminal cover, see page 23.

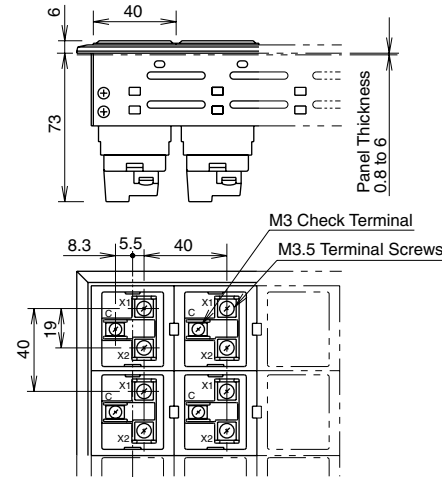

- w/Check Terminal
Terminal X1 is a positive pole; Terminal X2 and C (check terminal) are negative poles.
- Two-color Alternate
Terminal X1 is common.
Red (R) illumination: Terminal C
Green (G) illumination: Terminal X2

- Transformer
- One-color full
- 100/110, 200/220V AC
- 110VDC (DC-DC Converter)

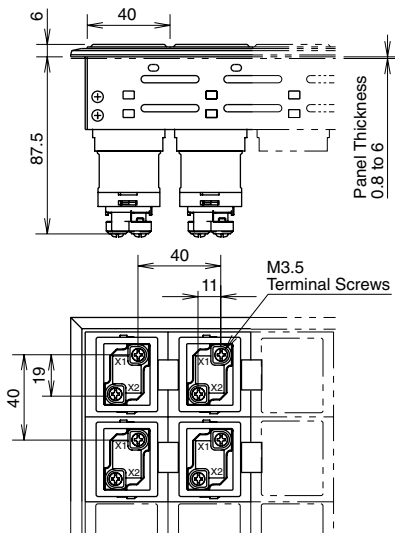

- Resistor
- One-color full
- 100/110V AC/DC

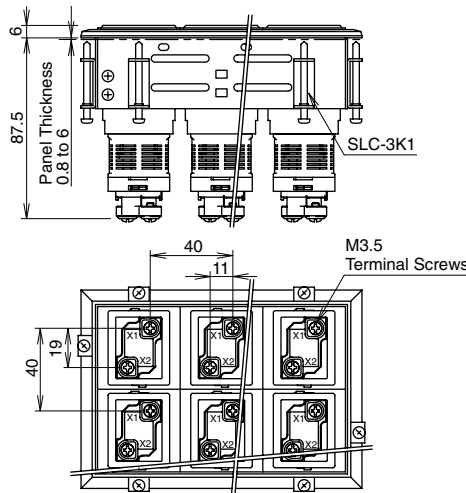

- On DC-DC Converter type units, Terminals X1 and X2 are positive and negative poles, respectively.

Type C (split-window)

- Full Voltage
- 24V AC/DC
- One-color full, 2 x LED lamps, Split-window

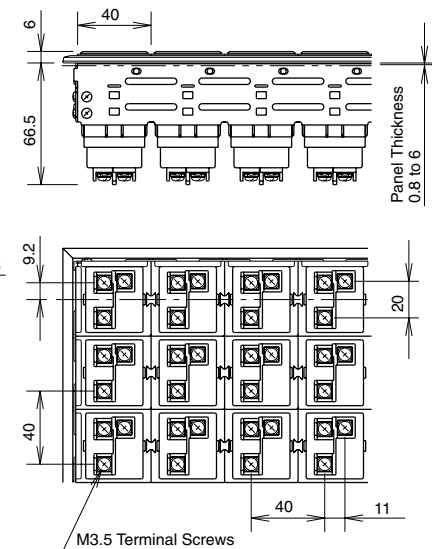

- Terminal X1 is COM terminal.
- For applicable terminal cover, see page 23.

All dimensions in mm.

Dimensions

All dimensions in mm.

[One-window, Type F only]

Full Voltage 24V AC/DC, One-color Full

Spot Illumination

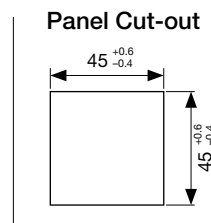
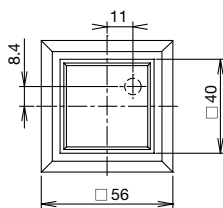
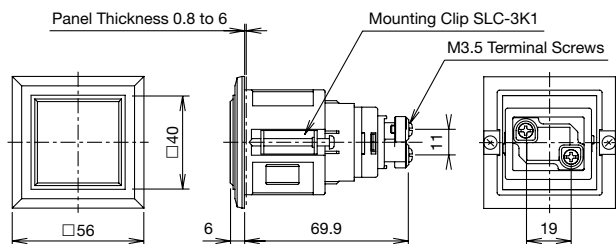

Full Voltage 24V DC, w/Check Terminal

Two-color Alternate 24V AC/DC

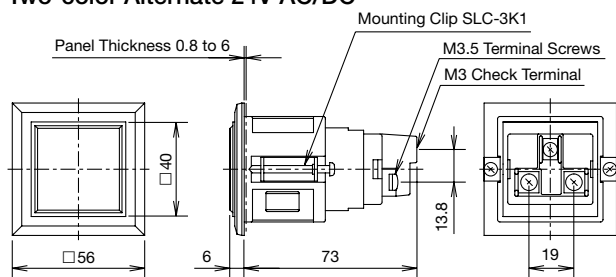

- w/Check Terminal Type
Terminal X1 is a positive pole; Terminals X2 and C (check terminal) are negative poles.
- Two-color Alternate Type
Red (R) illumination: X1 positive, C positive
Green (G) illumination: X1 positive, X2 positive
- See page 23 for terminal covers.

Transformer 100/110, 200/220V AC

DC-DC Converter 110V DC

Resistor 100/110V AC/DC

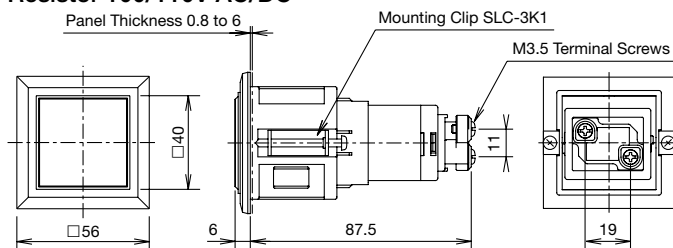

- On DC-DC converter type, Terminals X1 and X2 are positive and negative poles, respectively.
- Resistance
7.2 kΩ, 4W

[Two-window, Type C only]

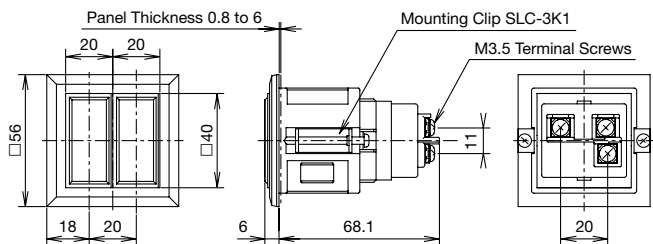

Terminal Connection

- For check terminal, DC-DC converter, and resistor, Terminals X1 and X2 are positive and negative poles, respectively.

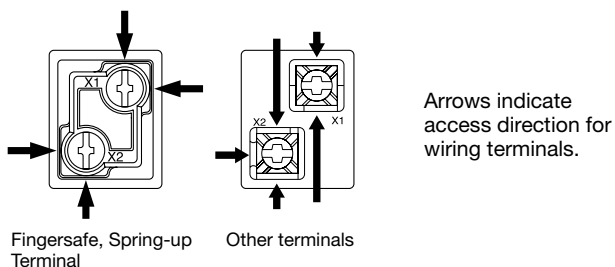

- For w/check terminal and two-color alternate units, Terminal X1 is a positive pole; Terminals X2 and C (check terminal) are negative poles. For two-color alternate, Terminal X1 is common.

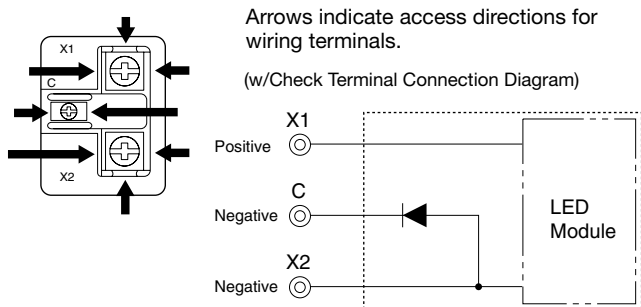

- Connection for Two-color alternate is as follows. Terminal X1 (+) is common (AC/DC). Red (R):Terminal C, Green (G):Terminal X2

(Two-color alternate Connection Diagram)

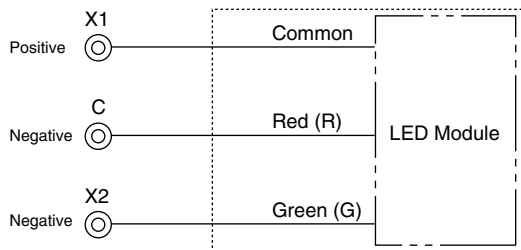

- For the split-window (Type C), Terminal X1 (+) is a common terminal. Terminal X2 is for upper illumination and Terminal X3 is for lower illumination (AC/DC).

Arrows indicate access direction for wiring terminals.

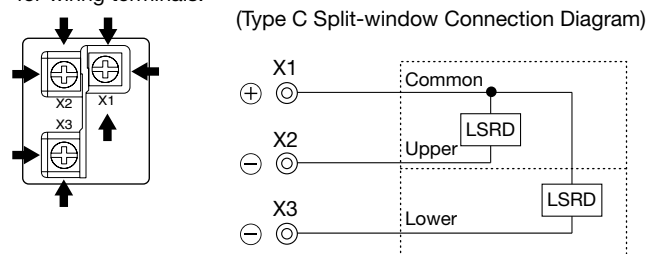

Recommended tightening torque:

- M3.5: 1 to 1.3 N·m
- M3: 0.6 to 1.0 N·m

Terminal Connection Using Jumpers

- For terminal connection of types F, H, L, V, and G (except Type C) using jumpers, jumpers can be used as shown below.

SLC40 Series

	Terminal X1	Terminal X2	Terminal C
Fingersafe, Spring-up Terminal (Note 1)	SLCN-JP44 SLCN-JP45	SLCN-JP44 SLCN-JP45	—
Others	SLC-JP40	SLC-JP41	SLC-JP42

Note 1: Fingersafe, spring-up terminals are used in one-color full illuminated (12, 24V AC/DC, 100/110, 200/220V AC, 110V DC).

- For Type C, jumpers can be used on Terminal X1 only as shown below.

Direction	• When using Type C only • When using Type C and Two-color alternate
Vertical	SLC-JP40
Horizontal	SLC-JP41

Note: Jumpers cannot be used when using Type C and fingersafe spring-up terminals.

[Examples of Using Jumpers]

Fingersafe Spring-up Terminal

When using two windows

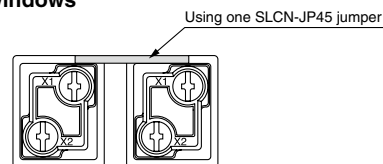

When using three windows

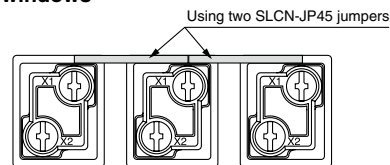

When using four windows

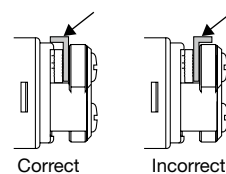
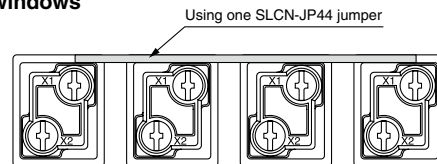

Jumpers (SLCN-JP44/45) have an orientation. Ensure that jumpers are installed correctly.

Part No. Development

SLC40N - 0405 - TD2FB - Example: A (10), G (5), R (5)
Specify the color code and the number of windows.

40 Series

When ordering Type H, L, V, G, or C units, enter the equivalents of Type F.

Frame Color
Black: B

Equivalent of Basic Size Windows	
Rows	Columns
01	01
02	02
03	03
04	04
05	05
06	06
07	07
08	
09	
10	
11	
12	
13	
14	
15	
16	
17	
18	
19	
20	
21	
22	
23	
24	

Unit		Operating Voltage (Built-in Lamp) (Code)			
LED Unit	Full Voltage (A, G, R, Y)	DD	24V AC/DC ±10% 2		
	Full Voltage (PW, S)	DDA	24V AC/DC ±10% 2		
	Full Voltage w/Check Terminal (A, G, R, Y)	DHM	24V DC ±10% 2		
	Full Voltage Two-color Alternate (R/G)	DW	24V AC/DC ±10% 2		
	Transformer (A, G, R, Y)	TD	100/110V AC ±10%	1	
			200/220V AC ±10%	2	
	Transformer (PW, S)	TDA	100/110V AC ±10%	1	
			200/220V AC ±10%	2	
	DC-DC Converter (A, G, R, Y)	CD	110V DC (90 to 140V DC)	1	
	Resistor (A, G, R, Y)	RN	100/110V AC/DC ±10%	1	
LED Lamp	One-color Full × 2 split window (Type C) (A, G, R, Y)	BA9S/13 Base	DP	24V AC/DC ±10% (LSRD-2)	2

Illumination Face Size (Code)	
• Type F 40 × 40 mm	F
• Type H 40 × 80 mm	H
• Type L 40 × 120 mm	L
• Type V 80 × 40 mm	V
• Type V 80 × 80 mm	G
• Type C (20 × 40 mm) × 2	C
• Type F Spot Illumination 40 × 40mm	FST

Illumination Color	
• Clear Lens Combination (Code)	
Amber	A
Green	G
Pure White	PW
Red	R
Blue	S
Yellow	Y
Red/Green	RG

• Color Screen Combination (Code)	
When color display is required at power off, order color screens. For details, see page 31.	
Amber	TA
Green	TG
Red	TR
Blue	TS
Yellow	TY
• Gray Lens Combination (Code)	
Amber	SA
Green	SG
Pure White	SPW
Red	SR
Blue	SS
Yellow	SY
• Type H, L, V, and G cannot be split-illuminated. • Enter the required number of color screens in ().	

The following color/voltage selections are also available.

Unit		Operating Voltage (Built-in Lamp) (Code)			
LED Unit	Full Voltage w/Check Terminal (PW, S)	DHMA	24V DC ±10% 2		
			120V AC ±10% 12		
	Transformer (A, G, R, Y)	TD	240V AC ±10% 24		
			380V AC ±10% 38		
			400/440V AC ±10% 4		
			480V AC ±10% 48		
	Transformer (PW, S)	TDA	120V AC ±10% 12		
			240V AC ±10% 24		
			380V AC ±10% 38		
			400/440V AC ±10% 4		
480V AC ±10% 48					
DC-DC Converter (PW, S)	CDA	110V DC (90 to 140V DC)	1		
Resistor (PW, S)	RNA	100/110V AC/DC ±10%	1		
LED Lamp	One-color Full window (Type C) (combination of PW, S only)	BA9S/13 Base	DPA	24V AC/DC ±10% (LSRD-2) × 2	2
				DPC	24V AC/DC ±10% (LSRD-2)

Terminal Cover

Ordering Terminal Covers

- The fingersafe, spring-up terminal types have integral covers, and do not require terminal covers.
- Terminals other than fingersafe, spring-up terminals do not have terminal covers and need covers ordered separately.

Applicable Terminal Covers (Material: PPE)

Series	Style	SLC30-VL5	SLC40-VL5	SLC30-VL6	SLC40-VL6	When using a terminal cover, the depth is extended shown as below. 
		 29H x 28W	 36H x 33.5W	 29H x 26W	 39H x 28W	
SLC30	zzzzzzzzOne-color Full w/Check Terminal			Applicable		+5.7 mm
	Two-color Alternate			Applicable		+5.7 mm
	Type C (half-type) one color Full x 2	Applicable				+2.5 mm
SLC40	One-color Full w/Check Terminal				Applicable	+4.7 mm
	Two-color Alternate				Applicable	+4.7 mm
	Type C (half-type) one color Full x 2		Applicable			+3 mm

Weight

Approximate weight of SLC combination display lights can be calculated in the formula below.

$$\text{Weight} = \left[\frac{A \times (\text{No. of Rows} + \text{No. of Columns})}{\text{Type F equivalent}} \right] + \left[\frac{B \times \text{No. of Windows}}{\text{Type F equivalent}} \right]$$

Frame Weight
Display Weight



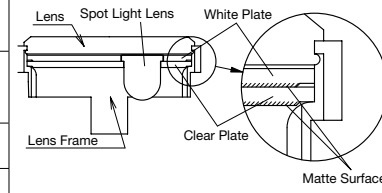

Series	A	B (including light source)				
		(Full Voltage) 12V AC/DC 24V AC/DC	(Transformer) 100/110V AC 200/220V AC	(Resistor) 100/110V DC 100/110V AC/DC (Note 2)	(DC-DC Converter) 110V DC	Type C Split-window (Type F equivalent)
SLC30 (Approx.)	22g	38g	85g	47g	54g	46g
SLC40 (Approx.)	30g	60g	126g	69g	77g	66g

Accessories / Replacement Parts

Accessories

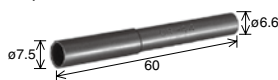
Name & Shape	Applicable Model	Part No.	Ordering No.	Package Quantity	Remarks
Spot Illumination Kit for Type F Window  (supplied with the spot illumination type SLC)	SLC30N	SLCN-3ST-F2	SLCN-3ST-F2	1	
	SLC40N	SLCN-4ST-F2	SLCN-4ST-F2	1	
White Screen for Spot Illumination	SLC30N	SLDN-3C-FW-ST1	SLDN-3C-FW-ST1	1	
	SLC40N	SLDN-4PF-FW-ST1	SLDN-4PF-FW-ST1	1	

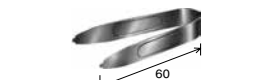
Tool Accessories

Name & Shape	Material	Part No.	Ordering No.	Package Quantity	Remarks
Lamp Holder Tool 	Rubber	OR-44	OR-44	1	Used for replacing LED lamps (LFTD) for SLC30 Type C (Split-window).
Lamp Holder Tool 	Rubber	OR-55	OR-55	1	Used for replacing LED lamps.
LED Unit Removal Tool 	Metal	MT-101	MT-101	1	Used for removing the LED unit for the SLC30/40 series.
Lens Unit Removal Tool 	Rubber (Ring: metal)	MT-S01	MT-S01	1	Used for removing the lens unit.

Marking Plate, Color Screens

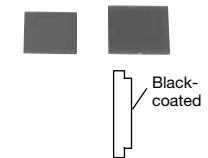
Name & Shape	Series	Applicable Window	Dimensions (mm)	Part No.	Ordering No.	Color Code	Package Quantity
Color Screen 	SLC30	F	27H × 27W × 1.0t	SLDN-3C-*	SLDN-3C-*	A: Amber C: Clear (clear screen) FW: White (white screen) G: Green R: Red (Type F) RL: Red (Except Type F) S: Blue Y: Yellow	5
		H and V	27H × 57W × 1.0t	SLC-3PH-*	SLC-3PH-*		
		H (split-window)	27H × 28.5W × 1.0t	SLC-3PH2-*	SLC-3PH2-*		
		L	27H × 87W × 1.0t	SLC-3PL-*	SLC-3PL-*		
		G	57H × 57W × 1.0t	SLC-3PG-*	SLC-3PG-*		
		C	12H × 27W × 1.0t	SLC-3PC-*	SLC-3PC-*		
	SLC40	F	35.8H × 35.8W × 1.0t	SLCN-4PF-*	SLCN-4PF-*		
		H and V	75.8H × 35.8W × 1.0t	SLC-4PH-*	SLC-4PH-*		
		L	35.8H × 115.8W × 1.0t	SLC-4PL-*	SLC-4PL-*		
		G	75.8H × 75.8W × 1.0t	SLC-4PG-*	SLC-4PG-*		
		C	15.8H × 35.8W × 1.0t	SLC-4PC-*	SLC-4PC-*		
Black Marking Plate 	SLC30	F	27H × 27W × 1.0t	SLDN-3C-WM	SLDN-3C-WM	-	1
		H and V	27H × 57W × 1.0t	SLC-3PH-FWM	SLC-3PH-FWM		
		H (split-window)	27H × 28.5W × 1.0t	SLC-3PH2-FWM	SLC-3PH2-FWM		
		L	27H × 87W × 1.0t	SLC-3PL-FWM	SLC-3PL-FWM		
		G	57H × 57W × 1.0t	SLC-3PG-FWM	SLC-3PG-FWM		
		C	12H × 27W × 1.0t	SLC-3PC-FWM	SLC-3PC-FWM		
	SLC40	F	35.8H × 35.8W × 1.0t	SLCN-4PF-FWM	SLCN-4PF-FWM		
		H and V	75.8H × 35.8W × 1.0t	SLC-4PH-FWM	SLC-4PH-FWM		
		L	35.8H × 115.8W × 1.0t	SLC-4PL-FWM	SLC-4PL-FWM		
		G	75.8H × 75.8W × 1.0t	SLC-4PG-FWM	SLC-4PG-FWM		
		C	15.8H × 35.8W × 1.0t	SLC-4PC-FWM	SLC-4PC-FWM		

Note: For insertion order into SLC frames or markings, see operating instructions on page 31 and 32.

Replacement Parts

Lens

Name & Shape	Description	Series	Applicable Window	Dimensions (mm)	Material	Part No.
	Clear	SLC30	F	28H × 28W × 2.8t	Acrylic	SLC-3LF
			H and V	28H × 58W × 2.8t		SLC-3LH
			L	28H × 88W × 2.8t		SLC-3LL
			G	58H × 58W × 2.8t		SLC-3LG
			C	13H × 28W × 2.8t		SLC-3LC
		SLC40	F	36.8H × 36.8W × 2.8t		SLC-4LF
			H and V	36.8H × 76.8W × 2.8t		SLC-4LH
			L	36.8H × 116.8W × 2.8t		SLC-4LL
			G	76.8H × 76.8W × 2.8t		SLC-4LG
			C	16.8H × 36.8W × 2.8t		SLC-4LC
	Gray	SLC30	F	28H × 28W × 2.8t	SLC-3LF-M	
			H and V	28H × 58W × 2.8t	SLC-3LH-M	
			L	28H × 88W × 2.8t	SLC-3LL-M	
			G	58H × 58W × 2.8t	SLC-3LG-M	
			C	13H × 28W × 2.8t	SLC-3LC-M	
		SLC40	F	36.8H × 36.8W × 2.8t	SLC-4LF-M	
			H and V	36.8H × 76.8W × 2.8t	SLC-4LH-M	
			L	36.8H × 116.8W × 2.8t	SLC-4LL-M	
			G	76.8H × 76.8W × 2.8t	SLC-4LG-M	
			C	16.8H × 36.8W × 2.8t	SLC-4LC-M	

Lens Frame

Shape	Series	Applicable Window	Material	Part No.	
	SLC30	F	ABS	SLC-3WF-BL	
		H		SLC-3WH-BL	
		H (split-window) (Note)		SLC-3WH2-BL	
		L	PC	SLC-3WL-BL	
		V	ABS	SLC-3WV-BL	
		G		SLC-3WG-BL	
	SLC40	SLC30	C	ABS	SLC-3WC-BL
			F		SLC-4WF-BL
		SLC40	H	PC	SLC-4WH-BL
			L		SLC-4WL-BL
			V	ABS	SLC-4WV-BL
			G		SLC-4WG-BL
			C		SLC-4WC-BL

Note: A light barrier is supplied.



LED Units

Series & Shape	Illumination	Operating Voltage	Rated Current	Part No.	Ordering No.	Color Code
 Weight: approx. 4.3g	One color full	12V AC/DC	Amber, green, red, yellow: 12mA	SLDN-31M-*	SLDN-31M-*T	Specify a color code in place of * in the Part No. A (amber) G (green) PW (pure white) R (red) S (blue) Y (yellow)
		24V AC/DC	Amber, red: 12mA Blue, green, pure white, yellow: 11mA	SLDN-32M-*	SLDN-32M-*T	
	Two-color alternate	24V DC	Red: 12mA/green: 11mA	SLDN-32MW-RG	SLDN-32MW-RGT	
 Weight: approx. 9.2g	One color full	24V AC/DC	Amber, blue, green, pure white, red, yellow: 15mA	SLCN-42M-*	SLCN-42M-*T	
	Two-color alternate	24V AC/DC	Red: 15mA/green: 15mA	SLCN-42MW-RG	SLCN-42MW-RGT	

Note: Blue (S) and PW (pure white) are 24V AC/DC only



Replacement Parts

LED Units for Spot Illumination

Series & Shape	Rated Voltage (AC: 50/60 Hz)	Rated Current	Part No.	Ordering No.	Color Code
SLC30  Weight: approx. 4.5g	24V AC/DC	Amber, red: 12mA Blue, green, pure white, yellow: 11mA	SLDN-32ST-*	SLDN-32ST-*T	Specify a color code in place of * in the Part No. A (amber) G (green) PW (pure white) R (red) S (blue) Y (yellow)
SLC40  Weight: approx. 9.4g	24V AC/DC	Amber, blue, green, pure white, red, yellow: 15mA	SLCN-42ST-*	SLCN-42ST-*T	

• Used with SLCN-ST-* spot illumination kit. The spot color is same as illumination surface.

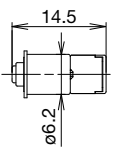

LED Lamps

Shape	Operating Voltage	Current Draw		Part No.	Ordering No.	Illumination Color	Package Quantity	Base
		DC Rating	AC Rating					
LFTD Lamp (SLC30)  	12V AC/DC	4mA		LFTD-1*N	Specify a color code in place of * in the Part No. A (amber) G (green) PW (pure white) R (red) S (blue)	1	SX6S/8 × 5.4	
				LFTD-1*NPN10		10		
	24V AC/DC			LFTD-2*N		1		
				LFTD-2*NPN10		10		
LSRD Lamp (SLC40) 	24V AC/DC	7mA	8mA	LSRD-2	-	1	BA9S/13	
				LSRD-2PN10		10		



• Only one color is available for LSRD so there are no codes to specify the color in the part no.

Accessories / Replacement Parts

Full Voltage Adapter

Shape	Series	Description	Part No.
	SLC30	One-color Full	SLDN-3DH
	SLC40		SLDN-4DH

Transformer Unit

Shape	Series	Illumination	Primary Voltage (50/60 Hz)	Applicable LED Unit	Part No.
	SLC30	LED	100/110V AC	SLDN-32M-*	SLDN-3TH1
			200/220V AC		SLDN-3TH2
	SLC40		100/110V AC	SLCN-42M-*	SLDN-4TH1
			200/220V AC		SLDN-4TH2

Separate Transformer (24V output, LED Unit)

Shape	Primary Voltage	Secondary Voltage	Part No.	Applicable LED Unit/Lamp
	100/110V AC	0.5W, 24V	TWR512	See the table below.
	200/220V AC	0.5W, 24V	TWR522	
	400/440V AC	0.5W, 24V	TWR542	

- Terminal cover (Part No. TWR-VL3) is supplied as standard.

Applicable LED Unit/Lamp

Series	LED Part No.	Applicable Model	
SLC30	LED Unit	SLDN-32M-*	One-color full (one unit per transformer)
		SLDN-32MW-RG	Two-color alternate (one unit per transformer)
	LED Lamp	LFTD-2*N	Type C (up to two lamps per transformer)
SLC40	LED Unit	SLCN-42M-*	One-color full (one unit per transformer)
		SLCN-42MW-RG	Two-color alternate (one unit per transformer)
	LED Lamp	LSRD-2	Type C (one unit per transformer)

- Specify a color code in place of *. See page 26.

Dimensions

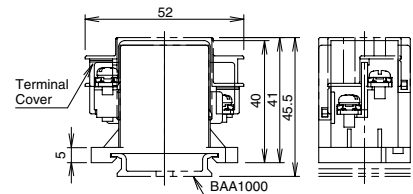
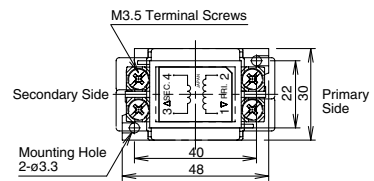

All dimensions in mm.

Accessories / Replacement Parts

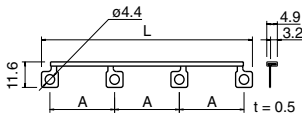
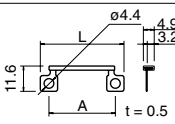
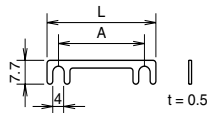
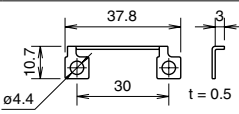
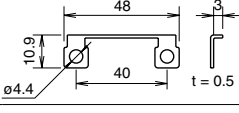
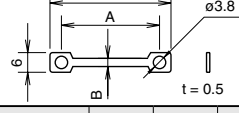
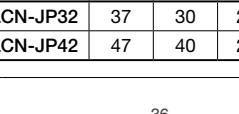
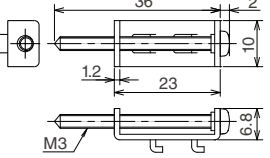
Name & Shape		Part No.	Ordering No.	Description & Dimensions	Package Quantity												
Jumper for fingersafe, Spring-up Terminal (Supplied)	Ring Terminal (for four windows) Rated Current: 3A	SLCN-JP34	SLCN-JP34PN10	For SLC30 Terminal X1, X2	 <table border="1"> <thead> <tr> <th>Part No.</th> <th>L</th> <th>A</th> </tr> </thead> <tbody> <tr> <td>SLCN-JP34</td> <td>97.8</td> <td>30</td> </tr> <tr> <td>SLCN-JP44</td> <td>128</td> <td>40</td> </tr> </tbody> </table>	Part No.	L	A	SLCN-JP34	97.8	30	SLCN-JP44	128	40	10		
	Part No.	L	A														
	SLCN-JP34	97.8	30														
	SLCN-JP44	128	40														
Ring Terminal (for 2 windows) Rated Current: 3A	SLCN-JP35	SLCN-JP35PN10	For SLC30 Terminal X1, X2	 <table border="1"> <thead> <tr> <th>Part No.</th> <th>L</th> <th>A</th> </tr> </thead> <tbody> <tr> <td>SLCN-JP35</td> <td>37.8</td> <td>30</td> </tr> <tr> <td>SLCN-JP45</td> <td>48</td> <td>40</td> </tr> </tbody> </table>	Part No.	L	A	SLCN-JP35	37.8	30	SLCN-JP45	48	40				
Part No.	L	A															
SLCN-JP35	37.8	30															
SLCN-JP45	48	40															
Spade Terminal Rated Current: 3A	SLC-JP30	SLC-JP30PN10	For SLC30 Terminal X1	 <table border="1"> <thead> <tr> <th>Part No.</th> <th>L</th> <th>A^{±0.1}</th> </tr> </thead> <tbody> <tr> <td>SLCN-JP30</td> <td>38</td> <td>30</td> </tr> <tr> <td>SLCN-JP40</td> <td>48</td> <td>40</td> </tr> </tbody> </table>	Part No.	L	A ^{±0.1}	SLCN-JP30	38	30	SLCN-JP40	48	40				
Part No.	L	A ^{±0.1}															
SLCN-JP30	38	30															
SLCN-JP40	48	40															
Ring Terminal Rated Current: 3A	SLC-JP33	SLC-JP33PN10	For SLC30 Terminal X2 or Terminal X1 of Type C														
Jumper for Other Terminals (Supplied)	Ring Terminal Rated Current: 3A	SLC-JP41	SLC-JP41PN10	For SLC40 Terminal X2													
	Ring Terminal Rated Current: 3A	SLC-JP32	SLC-JP32PN10	For SLC30 Terminal C (check terminal & 2-color alternate)	 <table border="1"> <thead> <tr> <th>Part No.</th> <th>L</th> <th>A^{±0.1}</th> <th>B</th> </tr> </thead> <tbody> <tr> <td>SLCN-JP32</td> <td>37</td> <td>30</td> <td>2.5</td> </tr> <tr> <td>SLCN-JP42</td> <td>47</td> <td>40</td> <td>2.5</td> </tr> </tbody> </table>	Part No.	L	A ^{±0.1}	B	SLCN-JP32	37	30	2.5	SLCN-JP42	47	40	2.5
	Part No.	L	A ^{±0.1}	B													
SLCN-JP32	37	30	2.5														
SLCN-JP42	47	40	2.5														
Ring Terminal Rated Current: 3A	SLC-JP42	SLC-JP42PN10	For SLC40 Terminal C (check terminal & 2-color alternate)														
Mounting Clips (Supplied)	SLC-3K1	SLC-3K1PN10	Used for fastening SLC units to panel cut-out from the rear of the panel. Weight: approx. 4.6g														

All dimensions in mm.

Jumper Application Examples

On Fingersafe, Spring-up Terminals



On Other Terminals

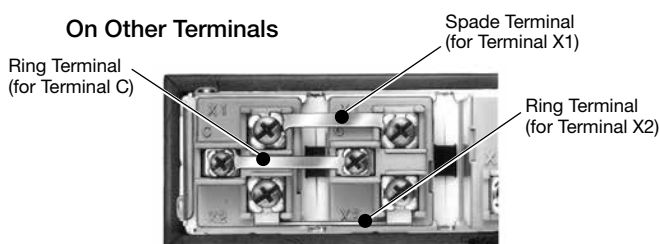

⚠ Safety Precautions

- Turn off the power to the SLC units before installation, removal, wiring, maintenance, or inspection. Before removing the LED units, make sure that power is turned off. Failure to turn off the power may cause an electrical shock, create fire hazards, or damage of LED units or lamps. Do not use the SLC units without the lens, otherwise ingress of foreign objects may cause short circuit, and LED units may be damaged resulting in the deterioration of LED brightness or no lighting.
- When lighting the SLC units continuously, observe the conditions described below. If the limits are exceeded, the SLC units may heat up and create fire hazards or damage the SLC units.
- For wiring, use wires of a proper size to meet the voltage and current requirements and tighten the terminal screws to the tightening torque shown below. Loose terminal screws may cause excessive heating, resulting in fire hazards.
- Do not install or operate the SLC units where the SLC units are subjected to direct sunlight. Excessive heating may create fire hazards or damage the SLC units.
- When replacing LED units or LED lamps, use IDEC products.

Operating Instructions

Notes for Continuous Lighting

Up to 10 SLC units (Type F equivalent) can be lit continuously. When more units are mounted, consider the following restrictions.

Full voltage

- Do not light more than 40% of the SLC units continuously, and light the units in a checker pattern.
- When more than 40% of the units are lit continuously, limit the lighting duration to 40 minutes. Before lighting the units again, ensure that all units have cooled down.
- When using 2-color alternate units, do not light the two colors simultaneously.

Transformer and DC-DC converter

- Light the units in a flashing or checker pattern.

When using the SLC units in other conditions, contact IDEC.

Notes for Panel Mounting

- When mounting the SLC units on a panel, determine the panel thickness taking the weights of the SLC units and wires into consideration.

Tightening Torque for Terminal Screws

- For wiring, use wires of a proper size to meet the voltage and current requirements and tighten the terminal screws to the tightening torque shown below.

Terminal Screw	Tightening Torque
M3	0.6 to 1.0
M3.5	1.0 to 1.3 N·m
M4	1.4 to 2.0 N·m

<Storage and Handling>

- Do not use the SLC where it is subjected to condensation caused by extreme temperature change.
- Do not use chemicals such as alcohol that degrade the property of acrylic.

<Operating Instructions>

- The illumination color may change depending on the decreasing brightness of LED, along with the period of use.
- The SLC can be used indoors only. Do not use outdoors.

Operating Instructions

When Using Blue and Green LED Units

When replacing LED units, avoid ESD to the LED pins, otherwise the internal LED elements may become damaged.

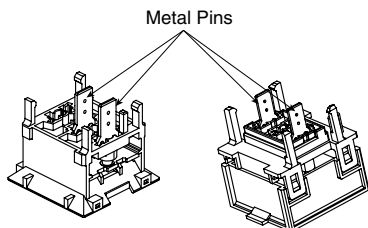

Precautions for Noise

When using the SLC units in an environment where the SLC is subjected to noise, connect a noise suppressor across terminals X1 and X2 as shown below.

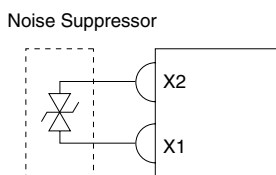

Notes for Using LED Units

Countermeasures against dim lighting

The SLC units contain a provision against dim lighting due to leakage current. If the LED unit appears to be dimly lit due to induced current from nearby AC lines, take appropriate countermeasures as described below.

[Sample Circuit]

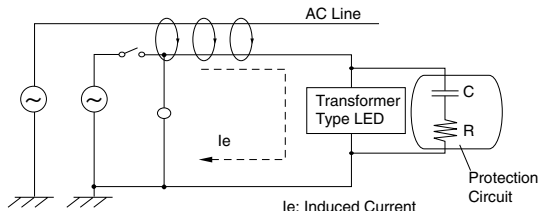

[Countermeasure]

As shown in the diagram above, connect an RC circuit in parallel with the transformer LED unit. For the values of the resistor and capacitor, see the following table.

	Operating Voltage	Capacitor C (μF)	Resistor R	
			(Ω)	(W)
SLC30	100/110V AC (50/60 Hz)	0.33	120	0.25
	200/220V AC (50/60 Hz)	0.10	120	0.25
SLC40	100/110V AC (50/60 Hz)	0.22	120	0.25
	200/220V AC (50/60 Hz)	0.10	120	0.25

LED Unit Internal Circuit

SLC30 Series

- SLDN-31M-* (12V AC/DC)
One-color full
(amber, green, red, yellow)

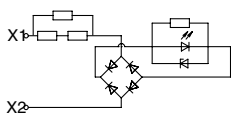

- SLDN-31M-W (12V AC/DC)
One-color full (white)

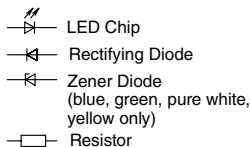
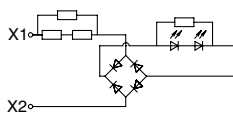

- SLDN-32M-* (24V AC/DC)
One-color full
(amber, blue, green, red, yellow)

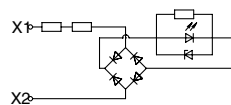

- SLDN-32-W (24V AC/DC)
One-color full (white)

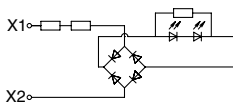

- SLDN-32MW-RG (24V AC/DC)
Two-color alternate

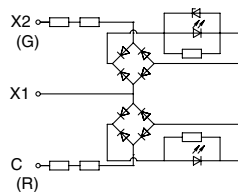

- SLDN-32ST-* (24V AC/DC)
Spot illumination

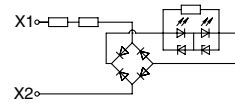

SLC40 Series

- SLDN-42M-* (24V AC/DC)
One-color full (amber, blue, green, red, yellow)

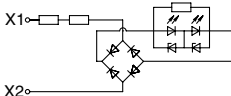

- SLDN-42-W (24V AC/DC)
One-color full (white)

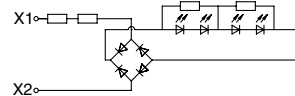

- SLDN-42MW-RG (24V AC/DC)
Two-color alternate

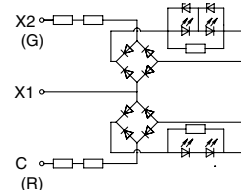



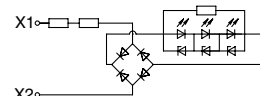





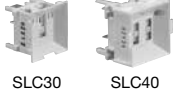



- SLDN-42ST-* (24V AC/DC)
Spot illumination













Operating Instructions

Type F, H, H2, L, V, G

Display Color Type	Light Source	Marking Plate/ Color Screen (Note 1) (Note 2)	Lens	ON Color (Color Code)	OFF Color
Standard (using clear lens)	 SLC30 SLC40 LED unit	 Matte Surface clear / white	 clear lens	amber (A), blue (S), green (G), pure white (PW) (Type F only), red (R), yellow (Y) red/green (two-color alternate) (RG) (no spot illumination for red/green two-color alternate)	White
Color Screen	 SLC30 SLC40 LED unit	 Matte Surface white / color	 clear lens	amber (TA), blue (TS), green (TG), red (TR), yellow (TY)	Same as ON color
	 SLC30 SLC40 LED unit	 Matte Surface clear / white	 clear lens	pure white (TPW, Type F only)	
Gray Lens (Note 3)	 SLC30 SLC40 LED unit	 Matte Surface clear / black (Note 4)	 gray lens	Legend Color amber (SA), blue (SS), green (SG), pure white (SPW, Type F only), red (SR), yellow (SY)	Gray

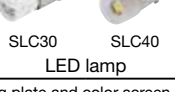
Type C (split-window)

Display Color Type	Light Source	Marking Plate/ Color Screen (Note 1) (Note 2)	Lens	ON Color (Color Code)	OFF Color
Standard (using clear lens)	 SLC30 SLC40 LED lamp	 Matte Surface color / white	 clear lens	amber (A), blue (S), green (G), red (R), yellow (Y)	White
	 SLC30 SLC40 LED lamp	 Matte Surface white / clear	 clear lens	pure white (PW)	
Gray Lens (Note 3)	 SLC30 SLC40 LED lamp	 Matte Surface color / black (Note 4)	 gray lens	Legend Color amber (SA), blue (SS), green (SG), red (SR), yellow (SY)	Gray
	 SLC30 SLC40 LED lamp	 Matte Surface clear / black (Note 4)	 gray lens	pure white (SPW)	

Note 1: Place the marking plate and color screen with the matte surfaces facing each other. The insertion order can be interchanged if necessary.

Note 2: Engrave on the flat surface of the screen/plate next to the lens.

Note 3: See page 24 for ordering the screen/plate as replacement parts.

Note 4: When ON: legends shown in the specified color on gray lens. When OFF: no legends shown on gray lens. Gray lens, black marking plate, and clear or color screen are used.

Note 5: Black marking plate has black coating. Engrave a reverse legend on the black-coated surface.

Type F Spot Illumination

Spot illumination LED unit and spot illumination kit are used.

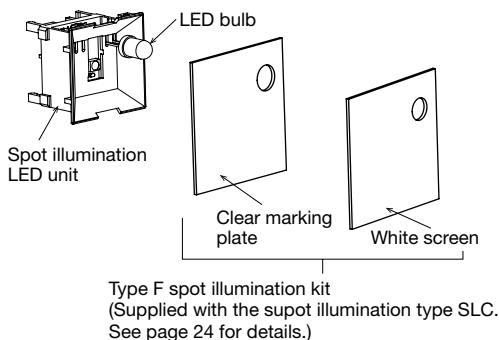

Color Screen/White Color Screen/Clear Screen Dimensions

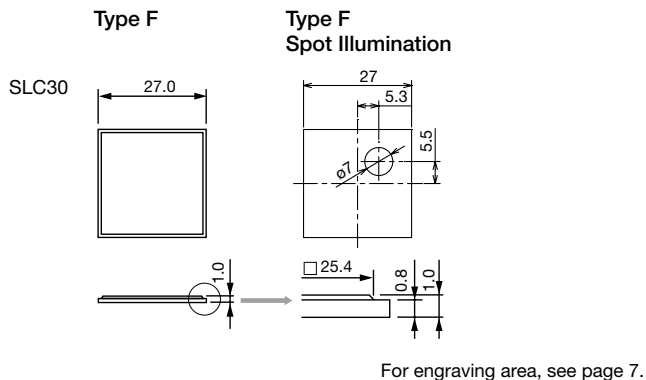

Marking on Films

In addition to white color screens or clear marking plates, legends can be engraved on thin marking films on Type F windows. Two sheets of 0.1-mm-thick films or one sheet of 0.2-mm-thick films is applicable. Marking films are not supplied with the SLC units and must be prepared by the user.

Dimensions

SLC30N: 27 × 27 mm
SLC40N: 35.8 × 35.8 mm

Film Material

Polyester is recommended.

Placement of Marking Film

When using a marking film, place the matte surfaces of the marking plate and color screen in the same direction to make a room of 0.2 mm for the marking film (matte surfaces are not facing each other). When not using a marking film, face the matte surfaces of marking plate and color screen each other.

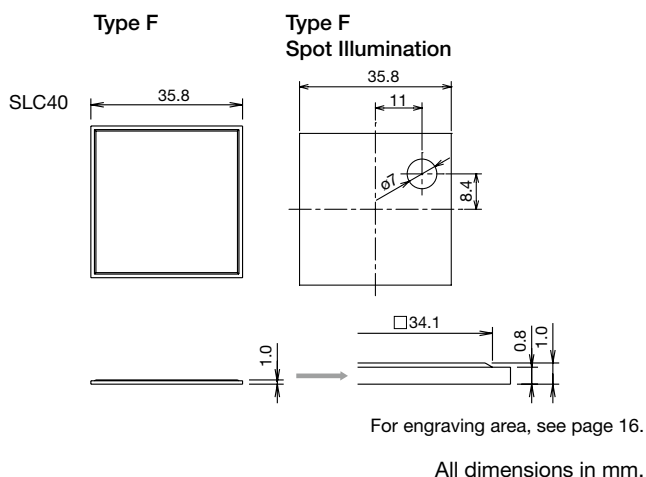

Using a marking film

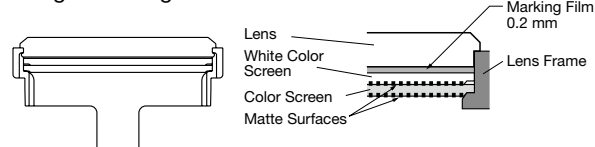

Not using a marking film

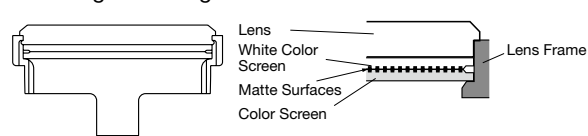

Operating Instructions

Removing the Windows

SLC30 Series

To remove the display window, insert the tip of a flat screwdriver into the slot on the bottom of the lens frame, and press down lightly on the screwdriver as shown.

For types G and V, do not put excessive force to remove one latch while pressing the other latch on the opposite side.

SLC40 Series (Extensible Windows)

The extensible window, featured on all SLC40 series units except Types C, G, and L, can be removed simply by pulling the upper portion out of the housing. For Types C, G, and L, insert the tip of a flat screwdriver into the slot on the bottom of the lens frame, and press up lightly.

When installing Type C windows, face the retaining latch with TOP marking upward.

All windows are shipped with the window retracted. After the windows are installed in a panel, they can be extended as required starting from the lowest row to the top row. Beware of the orientation when installing the units. When transporting the units, hold all windows in the retracted position.

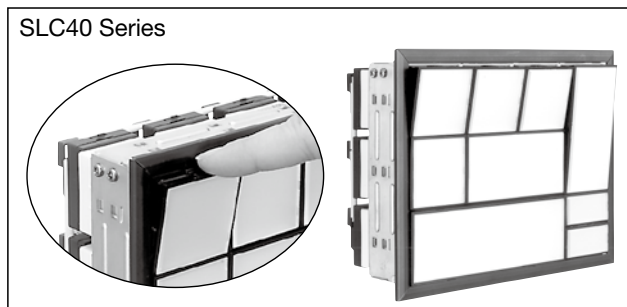

Maximum Number of Windows

SLC30 Series

LED Unit

- Full Voltage 12, 24V DC, w/Check Terminal, 2-color Alternate Up to 10 rows/26 columns (windows must be 200 at maximum)

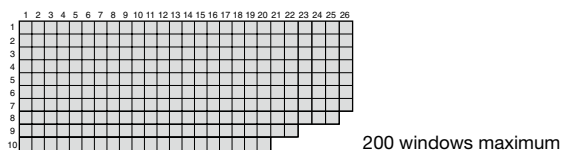

SLC40 Series

LED Unit

- Full Voltage 24V AC, w/Check Terminal, 2-color Alternate Up to 7 rows/24 columns (windows must be 126 at maximum)

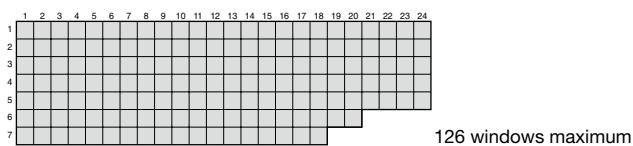

LED Unit

- Transformer 100/110V, 200/220V, 115/120, 230/240V AC DC-DC Converter, Resistor Up to 10 rows/26 columns (windows must be 75 at maximum)

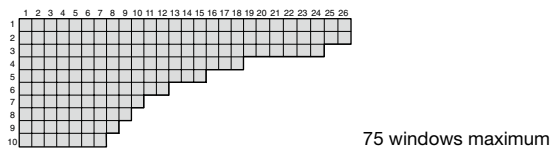

LED Unit

- Transformer, 100/110, 200/220, 115, 120, 230, 240, 380, 400/440, 480V AC DC-DC Converter, Resistor Up to 7 rows/24 columns (windows must be 60 at maximum)

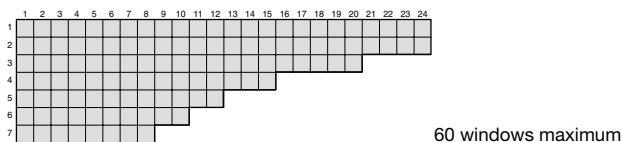

LED Lamp (Type C)

- Full Voltage 12, 24V DC

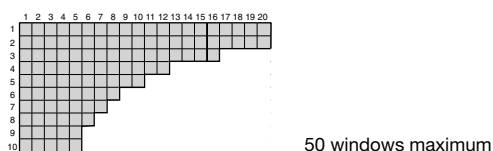

LED Lamp (Type C)

- Full Voltage 24V DC

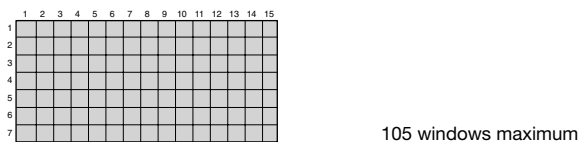

Replacing Lens, Marking Plate, and Color Screen

[Removal]

The lens has retaining projections (one or two each on right and left sides). To remove the lens, marking plate, and color screen from the lens frame, push open the lens frame with both hands as shown.

The lens can also be removed by inserting a screwdriver into one of the sides with recesses. Since the lens has an orientation due to projections, be sure to insert the screwdriver in the direction as shown.

Note: Take care not to damage or scratch the lens surface.

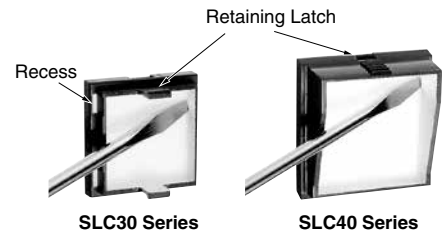
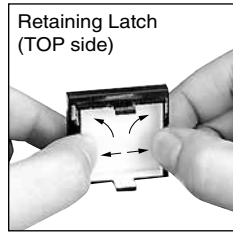

Retaining Projections Location

Series	Type F, G	Type C	Type H	Type L	Type V
SLC30 Series (Not extensible)					
SLC40 Series (Extensible Windows)	 Type G: Not extensible	 Not Extensible		 Not Extensible	

[Installation]

Install the color screen and marking plate into the lens frame.

To install the lens, insert its retaining projections into the recesses inside the lens frame, and press the lens on the other side into the lens frame.



Replacing the LED Unit

Ensure that power to the display lights has been turned off before removing the LED unit.

[Removal]

Use the LED unit removal tool (MT-101) to pull out the LED unit. For SLC30 units, pinch the top and bottom sides of the unit. For SLC40 units, pinch the right and left sides of the unit.

Note: When removing the LED unit from the housing, pull it out straight without pressing on the LED unit terminals.

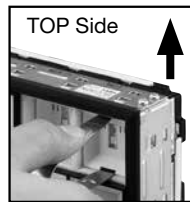

[Installation]

The LED unit has an orientation. To install the LED unit, place the metal pins on the LED unit to fit into the receptacles in the housing, and insert the LED unit.

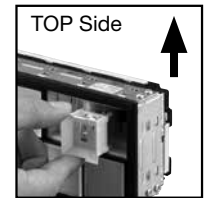

LED Unit Color Identification

Each LED unit has part no. and identification mark stamped.

Color	Code	Mark	Appearance	
			SLC30	SLC40
Red	R	● Red dot		
Green	G	● Green dot		
Amber	A	● Amber dot		
Blue	S	● Blue dot		

Note: Yellow (Y) LED unit uses a pure white LED unit with a yellow filter on the LED.

Color	Code	Mark	Appearance	
			SLC30	SLC40
Yellow	Y	P (Note)		
Pure White	PW	P		
Red/ Green	RG	—		

Replacing LED Lamps

SLC30, Type C

[Removal]

Push lamp holder tool OR-44 into the LED lamp kit, and push and turn clockwise to remove the lamp from the lamp holder.

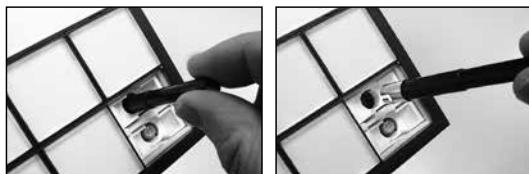

[Installation]

Insert the lamp into the lamp holder completely (lamps can be installed easily by using the handle part of lamp holder tool).

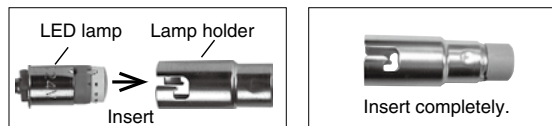

Insert the lamp holder tool into the lamp holder.



Align the insertion guides of the lamp holder with the grooves in the SLC unit. Push the lamp lightly and turn clockwise to install.

SLC40, Type C

Lamps can be replaced easily by using the lamp holder tool OR-55. When removing the lamp, reflector does not have to be removed.

Installation on Panel

Insert the units into a panel cut-out from the front, and install the mounting clips supplied with the units from the back as shown below. Apply loctite on the screws to prevent loosening. The number of mounting screws varies with the number of windows. Tighten the screws to a torque of 0.39 N·m to 0.49 N·m.

Example of Mounting Clip Positions (■)

Columns \ Rows	1	2	3 to 8	9 to 15	16 to 22	23 to 26
1 to 2	■ (Note)		■	■	■	■
3	■		■	■	■	■
4 to 6	■	■	■	■	■	■
7 to 10	■		■	■	■	■

Note: See below for Type V.

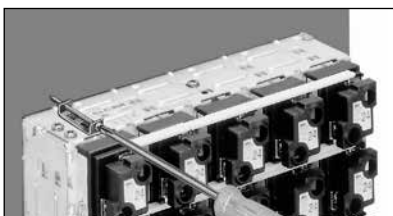

No. of Mounting Clips

Columns \ Rows	1 to 2	3 to 8	9 to 15	16 to 22	23 to 26
1 to 2	2	4 (6)	6 (8)	8	10
3 to 6	4 (6)	6 (8)	8 (10)	10 (12)	12 (14)
7 to 10	6 (8)	8 (10)	10 (12)	12	14

Note: Numbers in () show the number of mounting clips required for transformer, resistor, flicker, and DC-DC converter.

SLC30/40 Series Combination Display Lights Specification Sheet

Date of Order	
Customer	
Address	
Phone No.	
Contact	

Part No.

Color Code Designations

SLC N - - B -

A (), G (), PW (), R (), S (), Y ()
 TA (), TG (), TPW (), TR (), TS (), TY ()
 SA (), SG (), SPW (), SR (), SS (), SY ()

Illumination Face Size & Color Screen Code Designations

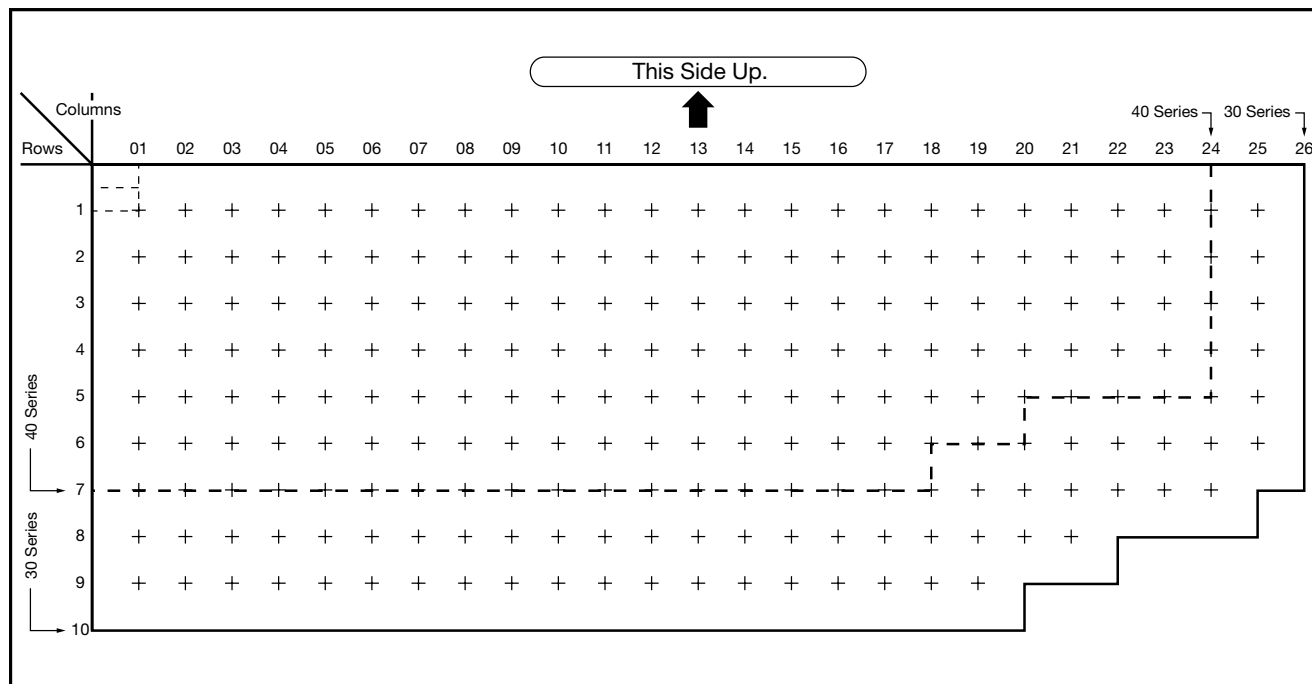

Part No. Development

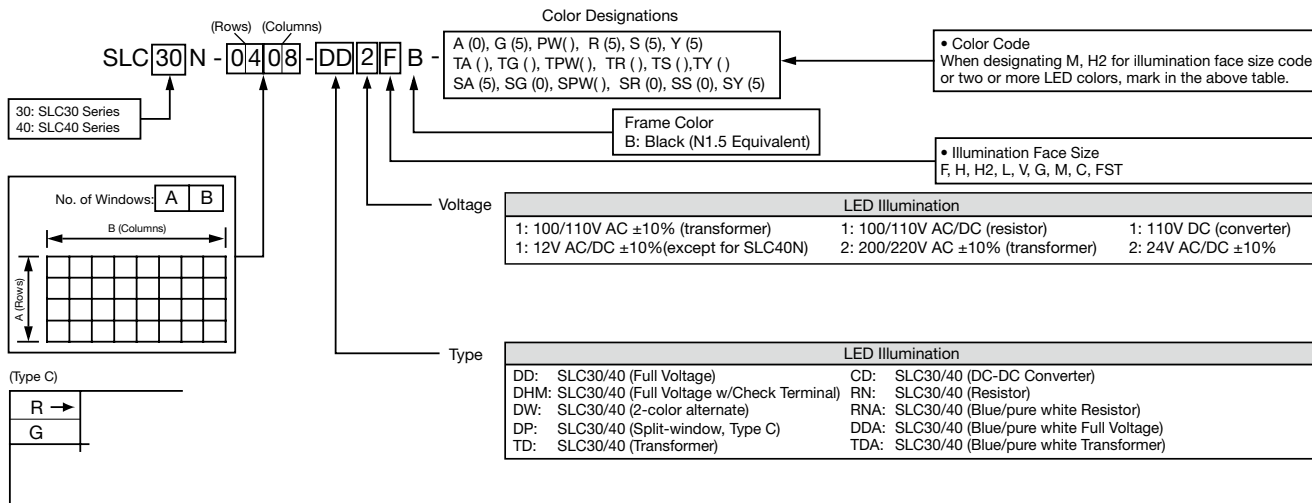

SLC30 Series Combination Display with Control Units

Combination of display lights and control units reduce labor of switch installation and minimizes installation space.

Switch for lamp test, external switch for system display can be integrated into the frame of combination display lights.

- Various control units can be installed in the window frame, with or without SLC units.
- Panel space can be reduced.
- Labor and time to install switches can be reduced.
- Flexibility of panel design is maximized.
- Up to 30 windows (3 rows × 10 columns) can be used.



Combination Display Lights

- One-color Full, Type F (30 × 30mm)
- Operating voltage: 24V AC/DC
- Illumination color:
Amber (A), Blue (S), Green (G), Pure White (PW), Red (R), Yellow (Y)
- Frame color: Black (B)

Control Unit (SLC30-LW)

Pushbutton (Square, Round w/Square Bezel)

- Contact: DPDT (gold or silver)
- Operation: Momentary
- Button color:
Black (B), Green (G), Red (R), Blue (S), Yellow (Y)

Illuminated Pushbutton

(Square, Round w/Square Bezel)

- Contact: DPDT (gold or silver)
- Operation: Momentary
- Illumination color:
Amber (A), Green (G), Pure White (PW), Red (R), Blue (S), Yellow (Y)

Selector Switch (Round w/Square Bezel)

Key Selector Switch (Round w/Square Bezel)

- Contact: DPDT (gold or silver)
- Operation: 2 or 3-position, maintained

Operation Angle	Operator Position and Contact Operation					
	Left ↙		Center ↑	Right ↘		
90° 2-position	Left Contact NO NC	Right Contact NO NC		Left Contact NO NC	Right Contact NO NC	
45° 3-position	Left Contact NO NC	Right Contact NO NC	Left Contact NO NC	Right Contact NO NC	Left Contact NO NC	Right Contact NO NC

Specifications

Connection Wire	SLC30: Solid wire $\phi 1.6 \times 2$ Stranded wire $2 \text{ mm}^2 \times 2$ SLC-LW: Stranded wire 1.25 mm^2 maximum
Terminal Screw	SLC30: M3.5 SLC30-LW: M3.0
Insulation Resistance	100 M Ω minimum (500V DC megger)
Dielectric Strength	SLC30: 2000V AC, 1 minute
	SLC30-LW: 2500V AC, 1 minute (between terminals of the same pole: 1000V AC, 1 minute)
Operating Temperature	-20 to 40°C (no freezing)
Storage Temperature	-25 to +60°C (no freezing)
Operating Humidity	45 to 85% RH (no condensation)

Contact Ratings

Rated Insulation Voltage	250V AC/DC
Rated Current	Gold contact: 3A Silver contact: 5A
Operating Voltage/Current	Gold contact: 125V AC/0.1A, 30V DC/0.1A (resistive load) Silver contact: 125V AC/3A, 250V AC/2A 30V DC/2A, 125V DC/0.4A (resistive load)

Combination Display Light Ratings

Operating Voltage	24V AC/DC
Rated Current	Amber, red: 12 mA Blue, green, pure white, yellow: 11 mA

Dimensions

All dimensions in mm.

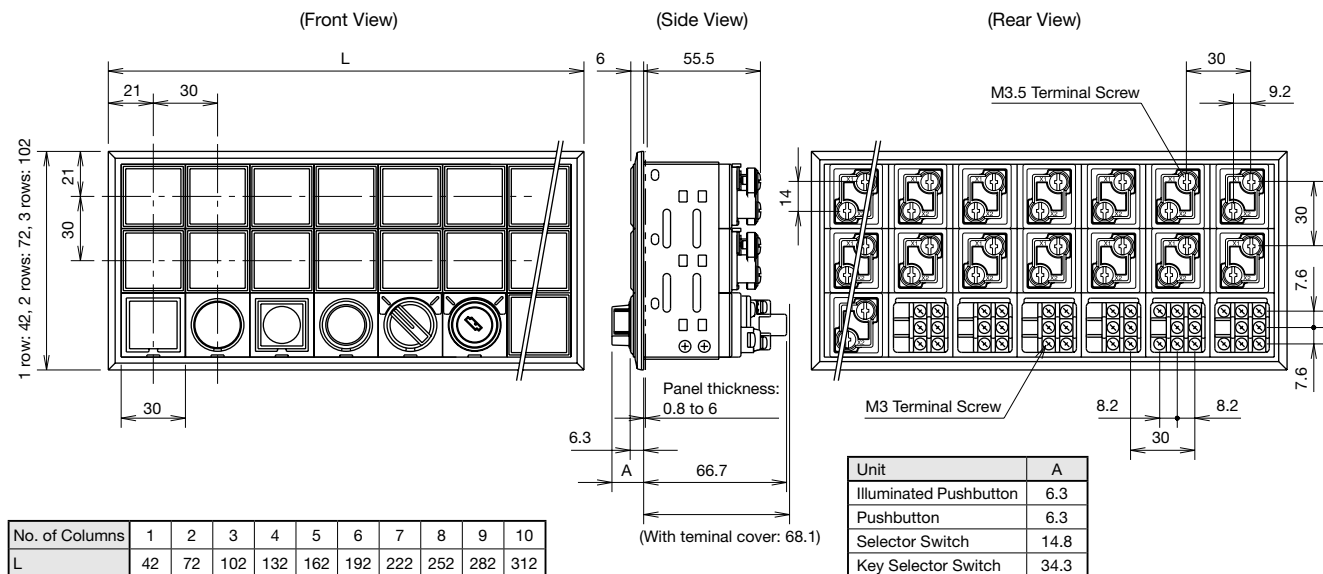

Panel Cut-out

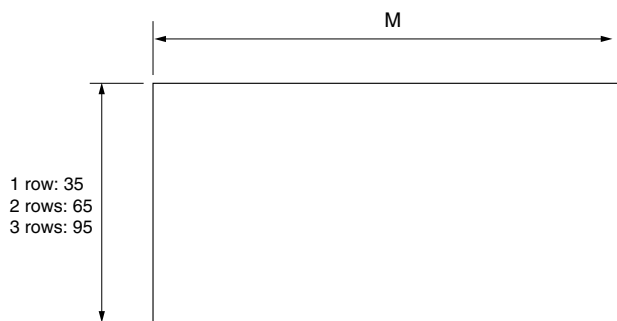

No. of Columns	1	2	3	4	5	6	7	8	9	10
M (mm)	35	65	95	125	155	185	215	245	275	305

Panel Cut-out (Bottom View)

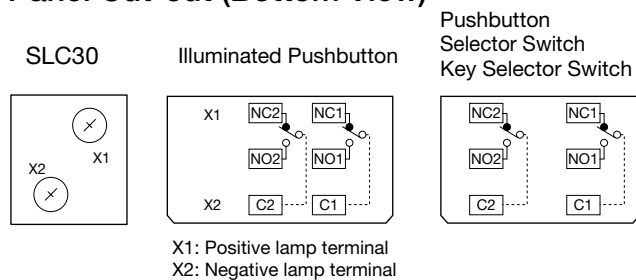

Ordering Information

- When ordering, complete the Specification Sheet on page 36.
- Control units (SLC30-LW) can be mounted on the bottom row only.
- Jumpers (SLCN-JP34/-JP35) are used between combination display lights only. Jumpers can not be used between control units, or between control units and combination display lights.
- See page 24 to 26 for accessories.
- Minimum unit size is 2 x 1 windows.

Safety Precautions

See page 29.

Operating Instructions

- When using the insulation terminal cover (LW-VL2M) for the control units
 - Install the terminal cover on the SLC units before wiring. Terminal covers cannot be installed after wiring.
 - Ring crimping terminals cannot be installed when terminal covers are used. Use spade terminals or wire directly.
- Do not remove the operator part of control units from the housing. Otherwise contacts may malfunction.
- On key selector switches, do not attempt to remove the key at any key retained position with excessive force (more than approx. 70N). Otherwise the operator part detaches from the housing, causing the contacts to malfunction.
- Use a lamp holder tool (OR-55) when replacing lamps for control units.
- For wiring, use wires of a proper size to meet the voltage and current requirements. Tighten the M3.5 terminal screws to a tightening torque shown below.

Terminal Screw	Recommended Tightening Torque
M3	0.6 to 1.0 N·m
M3.5	1.0 to 1.3 N·m

- Up to 10 SLC units (Type F equivalent) can be lit continuously. When more units are mounted, consider the following restrictions.
 - Do not light more than 40% of the SLC units continuously, and light the units in a checker pattern.
 - When more than 40% of the units are lit continuously, limit the lighting duration to 40 minutes. Before lighting the units again, ensure that all units have cooled down.
- For other operating instructions of display lights, see the relevant pages of SLC30/40 catalog.
- For other operating instructions of control units, see the relevant pages of ø22 LW control unit catalog.

SLC30/40 Series Combination Display Lights with Control Units Specification Sheet

Date of Order	
Customer	
Address	
Phone No.	
Contact	

Part No.

SLC30N- -DD2ML -

For illumination color and control unit, enter your requirements in the diagram below.

Illumination Color & Control Unit Specification

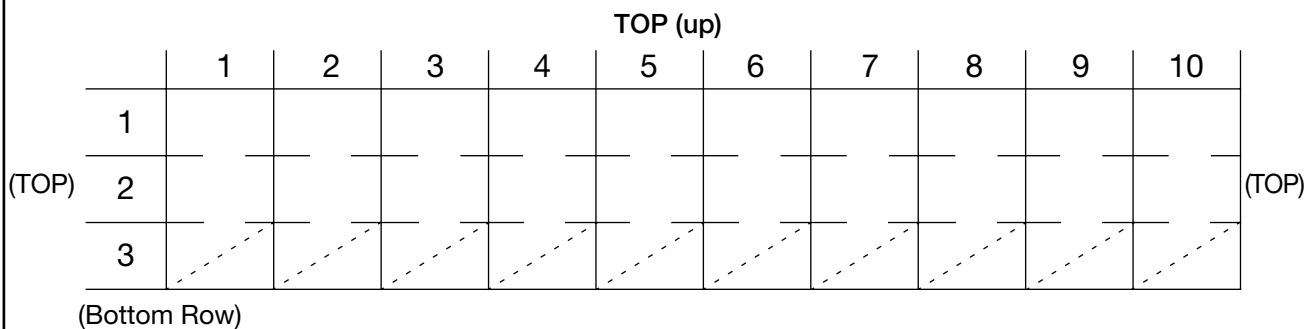

Specification Notes

- Use the specification diagram above for LED one-color Full (24V AC/DC) only.
- Control units can be mounted on the bottom row (the third row in the diagram above) only. Enter button or lens color code in the upper part and control unit code in the lower part (see the table below for control unit code). Display lights can be specified on the bottom row.
- Specify the TOP position (mounted onto the panel).

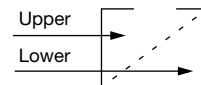

Control Unit Code

Code	Style (gold contact)	Code	Style (silver contact)
1	Square Illuminated Pushbutton (DPDT)	2	Square Illuminated Pushbutton (DPDT)
3	Round w/Square Bezel Illuminated Pushbutton (DPDT)	4	Round w/Square Bezel Illuminated Pushbutton (DPDT)
5	Square Pushbutton (DPDT)	6	Square Pushbutton (DPDT)
7	Round w/Square Bezel Pushbutton (DPDT)	8	Round w/Square Bezel Pushbutton (DPDT)
9	Selector Switch (2-position)	10	Selector Switch (2-position)
11	Selector Switch (3-position)	12	Selector Switch (3-position)
13*	Key Selector Switch (2-position)	14*	Key Selector Switch (2-position)
15*	Key Selector Switch (3-position)	16*	Key Selector Switch (3-position)

* Refer to the below table for key retaining positions.

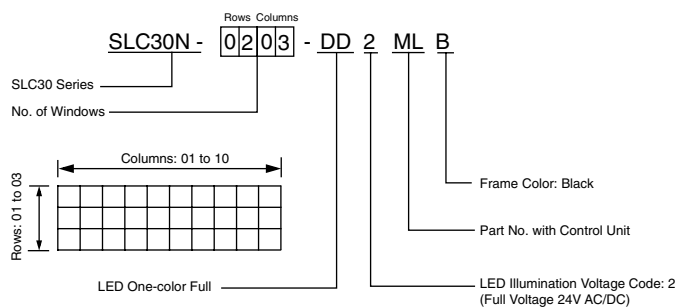

Key Code	A	B	C	L C R:			
2-position Maintained				Key can be released from these positions.			
Key Code	A	B	C	D	E	G	H
3-position Maintained							

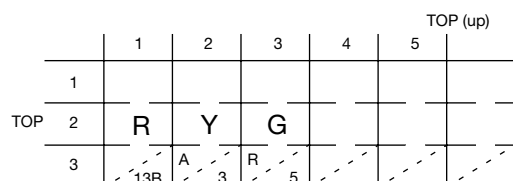

Ordering Terms and Conditions

Thank you for using IDEC Products.

By purchasing products listed in our catalogs, datasheets, and the like (hereinafter referred to as "Catalogs") you agree to be bound by these terms and conditions. Please read and agree to the terms and conditions before placing your order.

1. Notes on contents of Catalogs

- (1) Rated values, performance values, and specification values of IDEC products listed in this Catalog are values acquired under respective conditions in independent testing, and do not guarantee values gained in combined conditions.
Also, durability varies depending on the usage environment and usage conditions.
- (2) Reference data and reference values listed in Catalogs are for reference purposes only, and do not guarantee that the product will always operate appropriately in that range.
- (3) The specifications / appearance and accessories of IDEC products listed in Catalogs are subject to change or termination of sales without notice, for improvement or other reasons.
- (4) The content of Catalogs is subject to change without notice.

2. Note on applications

- (1) If using IDEC products in combination with other products, confirm the applicable laws / regulations and standards.
Also, confirm that IDEC products are compatible with your systems, machines, devices, and the like by using under the actual conditions. IDEC shall bear no liability whatsoever regarding the compatibility with IDEC products.
- (2) The usage examples and application examples listed in Catalogs are for reference purposes only. Therefore, when introducing a product, confirm the performance and safety of the instruments, devices, and the like before use. Furthermore, regarding these examples, IDEC does not grant license to use IDEC products to you, and IDEC offers no warranties regarding the ownership of intellectual property rights or non-infringement upon the intellectual property rights of third parties.
- (3) When using IDEC products, be cautious when implementing the following.
 - i. Use of IDEC products with sufficient allowance for rating and performance
 - ii. Safety design, including redundant design and malfunction prevention design that prevents other danger and damage even in the event that an IDEC product fails
 - iii. Wiring and installation that ensures the IDEC product used in your system, machine, device, or the like can perform and function according to its specifications
- (4) Continuing to use an IDEC product even after the performance has deteriorated can result in abnormal heat, smoke, fires, and the like due to insulation deterioration or the like. Perform periodic maintenance for IDEC products and the systems, machines, devices, and the like in which they are used.
- (5) IDEC products are developed and manufactured as general-purpose products for general industrial products. They are not intended for use in the following applications, and in the event that you use an IDEC product for these applications, unless otherwise agreed upon between you and IDEC, IDEC shall provide no guarantees whatsoever regarding IDEC products.
 - i. Use in applications that require a high degree of safety, including nuclear power control equipment, transportation equipment (railroads / airplanes / ships / vehicles / vehicle instruments, etc.), equipment for use in outer space, elevating equipment, medical instruments, safety devices, or any other equipment, instruments, or the like that could endanger life or human health
 - ii. Use in applications that require a high degree of reliability, such as provision systems for gas / waterworks / electricity, etc., systems that operate continuously for 24 hours, and settlement systems
 - iii. Use in applications where the product may be handled or used deviating from the specifications or conditions / environment listed in the Catalogs, such as equipment used outdoors or applications in environments subject to chemical pollution or electromagnetic interference
If you would like to use IDEC products in the above applications, be sure to consult with an IDEC sales representative.

3. Inspections

We ask that you implement inspections for IDEC products you purchase without delay, as well as thoroughly keep in mind management/maintenance regarding handling of the product before and during the inspection.

4. Warranty

- (1) Warranty period
The warranty period for IDEC products shall be one (1) year after purchase or delivery to the specified location. However, this shall not apply in cases where there is a different specification in the Catalogs or there is another agreement in place between you and IDEC.
- (2) Warranty scope
Should a failure occur in an IDEC product during the above warranty period for reasons attributable to IDEC, then IDEC shall replace or repair that product, free of charge, at the purchase location / delivery location of the product, or an IDEC service base. However, failures caused by the following reasons shall be deemed outside the scope of this warranty.
 - i. The product was handled or used deviating from the conditions / environment listed in the Catalogs
 - ii. The failure was caused by reasons other than an IDEC product
 - iii. Modification or repair was performed by a party other than IDEC
 - iv. The failure was caused by a software program of a party other than IDEC
 - v. The product was used outside of its original purpose
 - vi. Replacement of maintenance parts, installation of accessories, or the like was not performed properly in accordance with the user's manual and Catalogs
 - vii. The failure could not have been predicted with the scientific and technical standards at the time when the product was shipped from IDEC
 - viii. The failure was due to other causes not attributable to IDEC (including cases of force majeure such as natural disasters and other disasters)Furthermore, the warranty described here refers to a warranty on the IDEC product as a unit, and damages induced by the failure of an IDEC product are excluded from this warranty.

5. Limitation of liability

The warranty listed in this Agreement is the full and complete warranty for IDEC products, and IDEC shall bear no liability whatsoever regarding special damages, indirect damages, incidental damages, or passive damages that occurred due to an IDEC product.

6. Service scope

The prices of IDEC products do not include the cost of services, such as dispatching technicians. Therefore, separate fees are required in the following cases.

- (1) Instructions for installation / adjustment and accompaniment at test operation (including creating application software and testing operation, etc.)
- (2) Maintenance inspections, adjustments, and repairs
- (3) Technical instructions and technical training
- (4) Product tests or inspections specified by you

The above content assumes transactions and usage within your region. Please consult with an IDEC sales representative regarding transactions and usage outside of your region. Also, IDEC provides no guarantees whatsoever regarding IDEC products sold outside your region.

IDEC CORPORATION

Head Office 6-64, Nishi-Miyahara-2-Chome, Yodogawa-ku, Osaka 532-0004, Japan

USA IDEC Corporation
EMEA APEM SAS

Singapore IDEC Izumi Asia Pte. Ltd.
Thailand IDEC Asia (Thailand) Co., Ltd.
India IDEC Controls India Private Ltd.

China IDEC (Shanghai) Corporation
IDEC Izumi (H.K.) Co., Ltd.
Taiwan IDEC Taiwan Corporation

Japan IDEC Corporation

 www.idec.com

Specifications and other descriptions in this brochure are subject to change without notice.

2024 IDEC Corporation, All Rights Reserved.

