

KGN Series Control Stations

IP40 Enclosed Steel Control Stations For ø30 mm TWN/TWND Series Switches/Pilot Lights Various Control Stations are Available

Various control stations are available with most widely used combinations of switches/pilot lights (contact configurations, voltage, button colors, and nameplates).



Specifications

| | |
|--|---|
| Degree of Protection | IP40 (IEC60529) |
| Material (Enclosure) | Carbon steel plate (t=1.0mm) |
| Coating Color (Melamine coating) | Yellow semi-gloss (Munsell 5Y7/1) |
| Rated Insulation Voltage | 600V (Buzzer: 250V) |
| Insulation Resistance | 5 MΩ minimum |
| Dielectric Strength (Note 1) | Between live and dead parts: 2500V AC, 1 minute |
| Standard Operating Conditions (Note 2) | Ambient temperature: -25 to +50°C (no freezing) Relative humidity: 45 to 85% (no condensation) |
| Style | Wall mount (1 to 5 holes) |
| Cable Lead-in (Wall Mount) | Double knockouts On top: ø22 and ø27 mm On bottom: ø16 and ø20 mm |
| Applicable Switches/Pilot Lights | IDEC ø30 mm TWN/TWND series |

Note 1: Buzzer: 2000V AC, 1 minute

Note 2: Buzzer: -10 to +40°C

Contact Ratings (Contact Block)

| | | |
|---------------|--|-----------------------|
| Contact Block | Rated Insulation Voltage | 600V |
| | Rated Thermal Current | 10A |
| | Contact Ratings by Utilization Category IEC60947-5-1 | AC-15 (A600) DC-13 |

Operational Voltage and Current by Utilization Category

| Operational Voltage | | 24V | 48V | 50V | 110V | 220V | 440V |
|---------------------|--|-----|-----|-----|------|------|------|
| Operational Current | AC (50/60Hz) | | | | | | |
| | AC-12 Control of resistive loads and solid state loads | 10A | — | 10A | 10A | 6A | 2A |
| | AC-15 Control of electromagnetic loads (>72VA) | 10A | — | 7A | 5A | 3A | 1A |
| DC | DC-12 Control of resistive loads and solid state loads | 10A | 5A | — | 2.2A | 1.1A | — |
| | DC-13 Control of electromagnets | 5A | 2A | — | 1.1A | 0.6A | — |

Common

Minimum applicable load (reference value) = 3V AC/DC, 5 mA (the applicable range is subject to change according to the operating conditions)

Rubber Bushing (Supplied) Color: Black

| Enclosure Style | Supplied Bushing | | | Applicable Knockout Hole |
|-----------------|------------------|--------------|-------------|--------------------------|
| | Part No. | Outside Dia. | Inside Dia. | |
| 1 or 2 holes | GB-2 | ø30 mm | ø16 mm | ø20 or ø22 mm |
| 3 or 4 holes | GB-3 | ø38 mm | ø20 mm | ø27 mm |

Switches/Pilot Lights Mounting Holes

The holes for mounting switches/pilot lights are 30.5 mm in diameter with an anti-rotation notch. Mounting centers are 50 mm.

Double Knockouts

The top and bottom surfaces have double knockouts.

On top: ø22 and ø27 mm double knockouts





On bottom: ø16 and ø20 mm double knockouts

One rubber bushing is supplied to protect lead-in wires from damage on the wire surface; 1- and 2-hole enclosures are supplied with a bushing to fit ø20 and ø22 mm holes, and 3- and 5-hole enclosures with a bushing to fit a ø27 mm hole.



Control Stations with Switches/Pilot Lights























The control stations are available with a selected combination of switches/pilot lights as listed below. For the dimensions and mounting centers, see the figures on page 3.

| Switch/Pilot Light | Part No. | Specifications |
|--|------------------|---------------------------|
| Pushbutton  | ABN110 * | Flush, 1NO |
| | ABN101 * | Flush, 1NC |
| | ABN111 * | Flush, 1NO-1NC |
| | ABN311R | ø40 mushroom, 1NO-1NC |
| Pilot Light  | APN116DN * | Dome, 100/110V AC |
| | APN126DN * | Dome, 200/220V AC |
| Selector Switch  | ASN211N | Knob, 2-position, 1NO-1NC |
| | ASN320N | Knob, 3-position, 2NO |
| | ASN2K11N-N024401 | Key, 2-position, 1NO-1NC |
| Buzzer  | AZ11N | 110V AC |
| | AZ12N | 220V AC |



























Note: Specify a button or lens color code in place of *:
 Pushbutton: B (black), G (green)
 Pilot Light: G (green), R (red)

Control Stations

Package Quantity: 1

| Control Station | | Mounted Switch/Pilot Light | | |
|--------------------|-------------|--|------------------------|--------------------------------|
| Style | Part No. | Symbol | Part No. | NA Nameplate Legend |
| Wall Mount 1 hole | KGN1101NY * |  | ABN110 * | ON |
| | KGN1102NY |  | ABN311R | OFF |
| | KGN1103NY |  | APN116DNR | Without nameplate |
| | KGN1104NY |  | APN126DNR | Without nameplate |
| | KGN1105NY |  | ASN211N | HAND-AUTO |
| | KGN1106NY |  | ASN320N | HAND-OFF-AUTO |
| | KGN1107NY |  | ASN2K11N-N024401 | OFF-ON |
| | KGN1108NY |  | AZ11N | Without nameplate |
| Wall Mount 2 holes | KGN2101NY * |   | ABN110 * ABN101R | ON OFF |
| | KGN2102NY * |   | ABN111 * ABN111R | ON OFF |
| | KGN2103NY |   | APN116DNR APN116DNG | Without nameplate |
| | KGN2104NY |   | APN126DNR APN126DNG | Without nameplate |
| | KGN2105NY * |   | APN116DNR ABN111 * | Without nameplate STOP |
| | KGN2106NY * |   | APN126DNR ABN111 * | Without nameplate STOP |
| | KGN2107NY |   | APN116DNR ASN211N | Without nameplate HAND-AUTO |

Specify a button color code in place of * : B (black), G (green)

| Control Station | | Mounted Switch/Pilot Light | | |
|--------------------|--------------------|--|---|---|
| Style | Part No. | Symbol | Part No. | NA Nameplate Legend |
| Wall Mount 2 holes | KGN2108NY |   | APN126DNR ASN211N | Without nameplate HAND-AUTO |
| | KGN2109NY |   | APN116DNR ASN2K11N-N024401 | Without nameplate OFF-ON |
| | KGN2110NY |   | APN126DNR ASN2K11N-N024401 | Without nameplate OFF-ON |
| | KGN2113NY * |   | ABN110 * ABN311R | ON OFF |
| | KGN2116NY * |   | AZ11N ABN111 * | Without nameplate |
| | KGN2117NY * |   | AZ12N ABN111 * | Without nameplate |
| | KGN2118NY |   | AZ11N APN116DNR | Without nameplate |
| | KGN2119NY |   | AZ12N APN126DNR | Without nameplate |
| | Wall Mount 3 holes | KGN3102NY * |    | APN116DNR ABN110 * ABN101R |
| KGN3103NY * | |    | APN126DNR ABN110 * ABN101R | Without nameplate ON OFF |
| KGN3104NY * | |    | ABN111 * ABN111R ASN211N | ON OFF HAND-AUTO |
| Wall Mount 4 holes | KGN4101NY * |   | APN126DNR APN126DNG ABN111 * ABN111R | Without nameplate Without nameplate ON OFF |
| | KGN4102NY * | | APN126DNR ABN111 * ABN111R ASN211N | Without nameplate ON OFF HAND-AUTO |

Empty Enclosures

Package Quantity: 1

| Style | Part No. | Unit Mounting Hole | Switch/Pilot Light Mounting Centers |
|----------------------------------|----------|--------------------------------------|-------------------------------------|
| 1 hole (approx. 0.4 kg) | KGN111Y | With | |
| | KGN110Y | Without | |
| 2 holes (approx. 0.5 kg) | KGN211Y | With | |
| | KGN210Y | Without | |
| 3 holes (approx. 0.6 kg) | KGN311Y | With | |
| | KGN310Y | Without | |
| 4 holes (approx. 0.7 kg) | KGN411Y | With | |
| | KGN410Y | Without | |
| 5 holes (approx. 0.8 kg) | KGN511Y | With | |
| | KGN510Y | Without | |
| Switch/Pilot Light Mounting Hole | | Effective Depth inside the Enclosure | |
| | | | |
| All dimension in mm | | | |

Dimensions

All dimensions in mm.

KGN Control Station (Wall Mount)

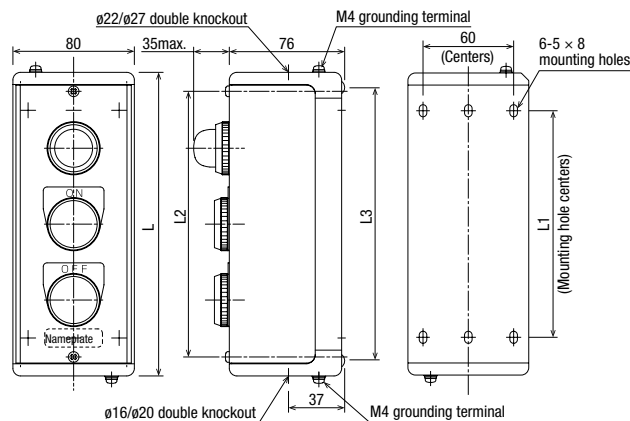

| | 1 hole | 2 holes | 3 holes | 4 holes | 5 holes |
|------------------|--------|---------|---------|---------|---------|
| | 111Y | 212Y | 313Y | 414Y | 510Y |
| L | 100 | 150 | 200 | 250 | 300 |
| L1 | 50 | 100 | 150 | 200 | 250 |
| L2 | 75 | 125 | 175 | 225 | 275 |
| L3 | 80 | 130 | 180 | 230 | 280 |
| Weight (Approx.) | 0.4 kg | 0.5 kg | 0.6 kg | 0.7 kg | 0.8 kg |

Instructions

Precautions for Opening the Knockout Hole

- The metal piece for the inner hole of $\varnothing 22$ or $\varnothing 16$ mm knockout has two linked parts to the outer hole. When breaking the knockout to make an inner hole, strike the inner metal piece at the cut parts (the hatched parts shown as point A at right) using a screwdriver tip or similar tool.
- When opening a larger hole of $\varnothing 27$ or $\varnothing 20$ mm, first make a smaller hole as described above. Then break the knockout for the larger hole using pliers.

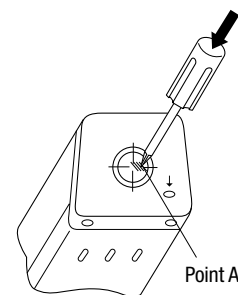

Accessories

Package Quantity: 1

| Name | Part No. | Applicable Enclosure | Applicable Knockout Hole |
|----------------|----------|----------------------|---|
| Rubber Bushing | GB-2 | KGN111Y | $\varnothing 20$ or $\varnothing 22$ mm |
| | | KGN110Y | |
| | | KGN211Y | |
| | | KGN210Y | |
| | GB-3 | KGN311Y | $\varnothing 27$ mm |
| | | KGN310Y | |
| | | KGN411Y | |
| | | KGN410Y | |
| | | KGN511Y | |
| | | KGN510Y | |

Ordering Information

When ordering control stations with switches/pilot lights:
Specify the Part No. of the control station.

When ordering enclosures without switches/pilot lights:
Specify the following items.

- Part No. of the enclosure
- Part No. and specifications of the switch/pilot light to be mounted (lens color, button color, etc.)
- Nameplate
- Other specifications

Ordering Example

| | Part No. of Enclosure | KGN311Y |
|-------------|----------------------------------|----------------------|
| ① ② ③ | Switch/Pilot Light and Nameplate | ① APN126DNR |
| | | ② ABN210B, with NA-1 |
| | | ③ ABN201R, with NA-2 |

Note: Any $\varnothing 30$ mm TWN/TWND series switch/pilot lights are selectable. However, take the effective depth inside the enclosure into consideration.

Ordering Terms and Conditions

Thank you for using IDEC Products.

By purchasing products listed in our catalogs, datasheets, and the like (hereinafter referred to as "Catalogs") you agree to be bound by these terms and conditions. Please read and agree to the terms and conditions before placing your order.

1. Notes on contents of Catalogs

- (1) Rated values, performance values, and specification values of IDEC products listed in this Catalog are values acquired under respective conditions in independent testing, and do not guarantee values gained in combined conditions.
Also, durability varies depending on the usage environment and usage conditions.
- (2) Reference data and reference values listed in Catalogs are for reference purposes only, and do not guarantee that the product will always operate appropriately in that range.
- (3) The specifications / appearance and accessories of IDEC products listed in Catalogs are subject to change or termination of sales without notice, for improvement or other reasons.
- (4) The content of Catalogs is subject to change without notice.

2. Note on applications

- (1) If using IDEC products in combination with other products, confirm the applicable laws / regulations and standards.
Also, confirm that IDEC products are compatible with your systems, machines, devices, and the like by using under the actual conditions. IDEC shall bear no liability whatsoever regarding the compatibility with IDEC products.
- (2) The usage examples and application examples listed in Catalogs are for reference purposes only. Therefore, when introducing a product, confirm the performance and safety of the instruments, devices, and the like before use. Furthermore, regarding these examples, IDEC does not grant license to use IDEC products to you, and IDEC offers no warranties regarding the ownership of intellectual property rights or non-infringement upon the intellectual property rights of third parties.
- (3) When using IDEC products, be cautious when implementing the following.
 - i. Use of IDEC products with sufficient allowance for rating and performance
 - ii. Safety design, including redundant design and malfunction prevention design that prevents other danger and damage even in the event that an IDEC product fails
 - iii. Wiring and installation that ensures the IDEC product used in your system, machine, device, or the like can perform and function according to its specifications
- (4) Continuing to use an IDEC product even after the performance has deteriorated can result in abnormal heat, smoke, fires, and the like due to insulation deterioration or the like. Perform periodic maintenance for IDEC products and the systems, machines, devices, and the like in which they are used.
- (5) IDEC products are developed and manufactured as general-purpose products for general industrial products. They are not intended for use in the following applications, and in the event that you use an IDEC product for these applications, unless otherwise agreed upon between you and IDEC, IDEC shall provide no guarantees whatsoever regarding IDEC products.
 - i. Use in applications that require a high degree of safety, including nuclear power control equipment, transportation equipment (railroads / airplanes / ships / vehicles / vehicle instruments, etc.), equipment for use in outer space, elevating equipment, medical instruments, safety devices, or any other equipment, instruments, or the like that could endanger life or human health
 - ii. Use in applications that require a high degree of reliability, such as provision systems for gas / waterworks / electricity, etc., systems that operate continuously for 24 hours, and settlement systems
 - iii. Use in applications where the product may be handled or used deviating from the specifications or conditions / environment listed in the Catalogs, such as equipment used outdoors or applications in environments subject to chemical pollution or electromagnetic interference
If you would like to use IDEC products in the above applications, be sure to consult with an IDEC sales representative.

3. Inspections

We ask that you implement inspections for IDEC products you purchase without delay, as well as thoroughly keep in mind management/maintenance regarding handling of the product before and during the inspection.

4. Warranty

- (1) Warranty period
The warranty period for IDEC products shall be one (1) year after purchase or delivery to the specified location. However, this shall not apply in cases where there is a different specification in the Catalogs or there is another agreement in place between you and IDEC.
- (2) Warranty scope
Should a failure occur in an IDEC product during the above warranty period for reasons attributable to IDEC, then IDEC shall replace or repair that product, free of charge, at the purchase location / delivery location of the product, or an IDEC service base. However, failures caused by the following reasons shall be deemed outside the scope of this warranty.
 - i. The product was handled or used deviating from the conditions / environment listed in the Catalogs
 - ii. The failure was caused by reasons other than an IDEC product
 - iii. Modification or repair was performed by a party other than IDEC
 - iv. The failure was caused by a software program of a party other than IDEC
 - v. The product was used outside of its original purpose
 - vi. Replacement of maintenance parts, installation of accessories, or the like was not performed properly in accordance with the user's manual and Catalogs
 - vii. The failure could not have been predicted with the scientific and technical standards at the time when the product was shipped from IDEC
 - viii. The failure was due to other causes not attributable to IDEC (including cases of force majeure such as natural disasters and other disasters)Furthermore, the warranty described here refers to a warranty on the IDEC product as a unit, and damages induced by the failure of an IDEC product are excluded from this warranty.

5. Limitation of liability

The warranty listed in this Agreement is the full and complete warranty for IDEC products, and IDEC shall bear no liability whatsoever regarding special damages, indirect damages, incidental damages, or passive damages that occurred due to an IDEC product.

6. Service scope

The prices of IDEC products do not include the cost of services, such as dispatching technicians. Therefore, separate fees are required in the following cases.

- (1) Instructions for installation / adjustment and accompaniment at test operation (including creating application software and testing operation, etc.)
- (2) Maintenance inspections, adjustments, and repairs
- (3) Technical instructions and technical training
- (4) Product tests or inspections specified by you

The above content assumes transactions and usage within your region. Please consult with an IDEC sales representative regarding transactions and usage outside of your region. Also, IDEC provides no guarantees whatsoever regarding IDEC products sold outside your region.

IDEC CORPORATION

Head Office 6-64, Nishi-Miyahara-2-Chome, Yodogawa-ku, Osaka 532-0004, Japan

USA IDEC Corporation
EMEA APEM SAS

Singapore IDEC Izumi Asia Pte. Ltd.
Thailand IDEC Asia (Thailand) Co., Ltd.
India IDEC Controls India Private Ltd.

China IDEC (Shanghai) Corporation
IDEC Izumi (H.K.) Co., Ltd.
Taiwan IDEC Taiwan Corporation

Japan IDEC Corporation

 www.idec.com

Specifications and other descriptions in this brochure are subject to change without notice.

2024 IDEC Corporation, All Rights Reserved.

