

ø16 H6 series Miniature Switches & Pilot Lights

Designed to ensure ease of operation and safety
Ideal for heavy duty applications such as machine tools

- Removable contact block makes installation and removal easy.
- Large operators; bezel size (ø24 mm, 24x24 mm)
- High operating force and long stroke prevent inadvertent operation.
- Contact blocks can be removed when units are mounted collectively.
- Shock- and vibration-resistant rugged design
- UL recognized, CSA certified
- EN compliant (EN 60947-1, EN 60947-5-1, TÜV approved)



- See website for details on approvals and standards.



Contact Ratings

Gold Contact

Rated Insulation Voltage	250V	
Rated Thermal Current	3A	
Rated Operating Voltage	125V AC	30V DC
Rated Operating Current (resistive load)	0.1A	0.1A
Contact Material	Gold plated silver	

Minimum applicable load (reference value): 5V AC/DC, 1 mA
 (Applicable range is subject to the operating condition and load.)

Silver Contact

Rated Insulation Voltage	250V					
Rated Thermal Current	5A					
Rated Operating Voltage	30V	125V	250V			
Rated Operating Current	AC 50/60 Hz	Resistive Load	—	3A	2A	
		Inductive Load	—	2A	1.5A	
	DC	Resistive Load	2A	0.4A	—	
		Inductive Load	1A	0.2A	—	
Contact Material	Silver					

AC inductive load: PF = 0.6 to 0.7, DC inductive load: L/R = 7 ms maximum

Built-in LED Lamp Ratings



Rated Voltage	5V DC	6V AC/DC		12V AC/DC	24V AC/DC		
Operating Voltage	5V DC ±5%	6V AC/DC ±10%		12V AC/DC ±10%	24V AC/DC ±10%		
Part No.	LFTD-5②	LFTD-6②	LFTD-1②	LFTD-2②			
Lamp Base	SX6S/8x5.4						
Current Draw	DC	A, G, PW, R	S	A, R	G, PW	S	
		8mA	7mA	7mA	6mA	8mA	7mA
Lamp Base Color	AC	—					9mA
		9mA	10mA	9mA	9mA	8mA	9mA
Lamp Base Color	Same as illumination color (PW: gray)						
Voltage Marking	Die stamped on the lamp base						
Life (reference value)	Approx. 50,000 hours (When used on complete DC at 25°C, luminance reduces to 50% of the initial intensity.)						
Internal Circuit	LFTD-5			LFTD-6/LFTD-1/LFTD-2			

- Specify a color code in place of ② in the Part No.
 A (amber), G (green), PW (pure white), R (red), S (blue)
- Use a PW (pure white) LED lamp for yellow illumination.

Specifications

Operating Temperature	-25 to +55°C (no freezing)	
Storage Temperature	-30 to +80°C	
Operating Humidity	45 to 85% RH (no condensation)	
Contact Resistance	50 mΩ maximum (initial value)	
Insulation Resistance	100 MΩ minimum (500V DC megger)	
Dielectric Strength	Switch Unit	Between live part and ground: 2,500V, 1 minute Between terminals of different poles: 2,500V, 1 minute Between terminals of the same pole: 1,000V, 1 minute
	Illumination Unit	Between live part and ground: 2,500V, 1 minute
Vibration Resistance	Operating extremes: 5 to 55 Hz, amplitude 0.5 mm	
Shock Resistance	Operating extremes: 100 m/s ² (10G) Damage limits: 1,000 m/s ² (100G)	
Mechanical Durability (minimum operations)	Momentary:	1,000,000
	Maintained:	200,000
	Selector switch:	250,000
	Key selector switch:	250,000
	Illuminated selector switch:	250,000
Electrical Durability (minimum operations)	Momentary:	100,000 (at 1,800 operations/hour)
	Maintained:	100,000 (at 1,200 operations/hour)
	Selector switch:	100,000
Degree of Protection	IP65 (IEC 60529)	
Terminal Style	Solder/tab terminal #110 PC board terminal	
Weight (approx.)	HA1L-M1C24: 18g HA1P-1C04: 17g HA1P-14: 13g HA1B-M1C2: 16g HA1S-2C2: 18g HA1K-2C2A: 33g HA1F-2C24: 20g	

HA1L / HA2L Illuminated Pushbuttons

Style	Operation	Contact Material	Operating Voltage	Contact	Part No.		② Illumination Color Code	
					Solder/Tab Terminal	PC Board Terminal		
Round HA1L  Marking plate size: ø18.4mm Engraving area: ø16.8mm (Depth: 0.5mm max.)	Momentary	Gold	5V DC ±5%	SPDT	HA1L-M1C11②	HA1L-M1C11V②	Specify a color code in place of ② in the Part No. A: amber G: green PW: pure white R: red S: blue Y: yellow	
				DPDT	HA1L-M1C21②	HA1L-M1C21V②		
			12V AC/DC ±10%	SPDT	HA1L-M1C13②	HA1L-M1C13V②		
				DPDT	HA1L-M1C23②	HA1L-M1C23V②		
			24V AC/DC ±10%	SPDT	HA1L-M1C14②	HA1L-M1C14V②		
				DPDT	HA1L-M1C24②	HA1L-M1C24V②		
		DPDT	HA1L-M1C61②					
		12V AC/DC ±10%	SPDT	HA1L-M1C53②				
			DPDT	HA1L-M1C63②				
		24V AC/DC ±10%	SPDT	HA1L-M1C54②				
			DPDT	HA1L-M1C64②				
		Maintained	Gold	5V DC ±5%	SPDT	HA1L-A1C11②		HA1L-A1C11V②
	DPDT				HA1L-A1C21②	HA1L-A1C21V②		
	12V AC/DC ±10%			SPDT	HA1L-A1C13②	HA1L-A1C13V②		
				DPDT	HA1L-A1C23②	HA1L-A1C23V②		
	24V AC/DC ±10%			SPDT	HA1L-A1C14②	HA1L-A1C14V②		
				DPDT	HA1L-A1C24②	HA1L-A1C24V②		
	DPDT		HA1L-A1C61②					
	12V AC/DC ±10%		SPDT	HA1L-A1C53②				
			DPDT	HA1L-A1C63②				
	24V AC/DC ±10%		SPDT	HA1L-A1C54②				
			DPDT	HA1L-A1C64②				
	Square HA2L  Marking plate size: □18.4mm Engraving area: □16.4mm (Depth: 0.5mm max.)		Momentary	Gold	5V DC ±5%	SPDT		HA2L-M1C11②
		DPDT				HA2L-M1C21②		HA2L-M1C21V②
12V AC/DC ±10%		SPDT			HA2L-M1C13②	HA2L-M1C13V②		
		DPDT			HA2L-M1C23②	HA2L-M1C23V②		
24V AC/DC ±10%		SPDT			HA2L-M1C14②	HA2L-M1C14V②		
		DPDT			HA2L-M1C24②	HA2L-M1C24V②		
DPDT		HA2L-M1C61②						
12V AC/DC ±10%		SPDT		HA2L-M1C53②				
		DPDT		HA2L-M1C63②				
24V AC/DC ±10%		SPDT		HA2L-M1C54②				
		DPDT		HA2L-M1C64②				
Maintained		Gold		5V DC ±5%	SPDT	HA2L-A1C11②	HA2L-A1C11V②	
	DPDT		HA2L-A1C21②		HA2L-A1C21V②			
	12V AC/DC ±10%		SPDT	HA2L-A1C13②	HA2L-A1C13V②			
			DPDT	HA2L-A1C23②	HA2L-A1C23V②			
	24V AC/DC ±10%		SPDT	HA2L-A1C14②	HA2L-A1C14V②			
			DPDT	HA2L-A1C24②	HA2L-A1C24V②			
	DPDT	HA2L-A1C61②						
	12V AC/DC ±10%	SPDT	HA2L-A1C53②					
		DPDT	HA2L-A1C63②					
	24V AC/DC ±10%	SPDT	HA2L-A1C54②					
		DPDT	HA2L-A1C64②					

- See page 24 for marking plate size and engraving area.
- One LED lamp is installed in an illuminated pushbutton.

HA3L / HA4L / HA1L-M3 / A3 Illuminated Pushbuttons

Style	Operation	Contact Material	Operating Voltage	Contact	Part No.		② Illumination Color Code	
					Solder/Tab Terminal	PC Board Terminal		
Round w/Square Bezel HA3L  Marking plate size: ø18.4mm Engraving area: ø16.8mm (Depth: 0.5mm max.)	Momentary	Gold	5V DC ±5%	SPDT	HA3L-M1C11②	HA3L-M1C11V②	Specify a color code in place of ② in the Part No. A: amber G: green PW: pure white R: red S: blue Y: yellow	
				DPDT	HA3L-M1C21②	HA3L-M1C21V②		
			12V AC/DC ±10%	SPDT	HA3L-M1C13②	HA3L-M1C13V②		
				DPDT	HA3L-M1C23②	HA3L-M1C23V②		
			24V AC/DC ±10%	SPDT	HA3L-M1C14②	HA3L-M1C14V②		
				DPDT	HA3L-M1C24②	HA3L-M1C24V②		
		DPDT	HA3L-M1C61②					
		12V AC/DC ±10%	SPDT	HA3L-M1C53②				
			DPDT	HA3L-M1C63②				
		24V AC/DC ±10%	SPDT	HA3L-M1C54②				
			DPDT	HA3L-M1C64②				
		Maintained	Gold	5V DC ±5%	SPDT	HA3L-A1C11②		HA3L-A1C11V②
	DPDT				HA3L-A1C21②	HA3L-A1C21V②		
	12V AC/DC ±10%			SPDT	HA3L-A1C13②	HA3L-A1C13V②		
				DPDT	HA3L-A1C23②	HA3L-A1C23V②		
	24V AC/DC ±10%			SPDT	HA3L-A1C14②	HA3L-A1C14V②		
				DPDT	HA3L-A1C24②	HA3L-A1C24V②		
	DPDT		HA3L-A1C61②					
	12V AC/DC ±10%		SPDT	HA3L-A1C53②				
			DPDT	HA3L-A1C63②				
	24V AC/DC ±10%		SPDT	HA3L-A1C54②				
			DPDT	HA3L-A1C64②				
	Square w/Four-sided Barrier HA4L  Marking plate size: □18.4mm Engraving area: □16.4mm (Depth: 0.5mm max.)		Momentary	Gold	5V DC ±5%	SPDT		HA4L-M1C11②
		DPDT				HA4L-M1C21②		HA4L-M1C21V②
12V AC/DC ±10%		SPDT			HA4L-M1C13②	HA4L-M1C13V②		
		DPDT			HA4L-M1C23②	HA4L-M1C23V②		
24V AC/DC ±10%		SPDT			HA4L-M1C14②	HA4L-M1C14V②		
		DPDT			HA4L-M1C24②	HA4L-M1C24V②		
DPDT		HA4L-M1C61②						
12V AC/DC ±10%		SPDT		HA4L-M1C53②				
		DPDT		HA4L-M1C63②				
24V AC/DC ±10%		SPDT		HA4L-M1C54②				
		DPDT		HA4L-M1C64②				
ø30 Mushroom HA1L-□3  Marking plate size: ø14.8mm Engraving area: ø12.8mm (Depth: 0.5mm max.)		Momentary		Gold	5V DC ±5%	SPDT	HA1L-M3C11②	HA1L-M3C11V②
	DPDT		HA1L-M3C21②			HA1L-M3C21V②		
	12V AC/DC ±10%		SPDT		HA1L-M3C13②	HA1L-M3C13V②		
			DPDT		HA1L-M3C23②	HA1L-M3C23V②		
	24V AC/DC ±10%		SPDT		HA1L-M3C14②	HA1L-M3C14V②		
			DPDT		HA1L-M3C24②	HA1L-M3C24V②		
	DPDT		HA1L-M3C61②					
	12V AC/DC ±10%		SPDT	HA1L-M3C53②				
			DPDT	HA1L-M3C63②				
	24V AC/DC ±10%		SPDT	HA1L-M3C54②				
			DPDT	HA1L-M3C64②				
	Maintained		Gold	5V DC ±5%	SPDT	HA1L-A3C11②	HA1L-A3C11V②	
		DPDT			HA1L-A3C21②	HA1L-A3C21V②		
		12V AC/DC ±10%		SPDT	HA1L-A3C13②	HA1L-A3C13V②		
				DPDT	HA1L-A3C23②	HA1L-A3C23V②		
		24V AC/DC ±10%		SPDT	HA1L-A3C14②	HA1L-A3C14V②		
				DPDT	HA1L-A3C24②	HA1L-A3C24V②		
		DPDT	HA1L-A3C61②					
		12V AC/DC ±10%	SPDT	HA1L-A3C53②				
			DPDT	HA1L-A3C63②				
		24V AC/DC ±10%	SPDT	HA1L-A3C54②				
			DPDT	HA1L-A3C64②				

• See page 24 for marking plate size and engraving area. • One LED lamp is installed in an illuminated pushbutton.

Dimensions

All dimensions in mm.

Round
Square
Round w/Square
Bezel

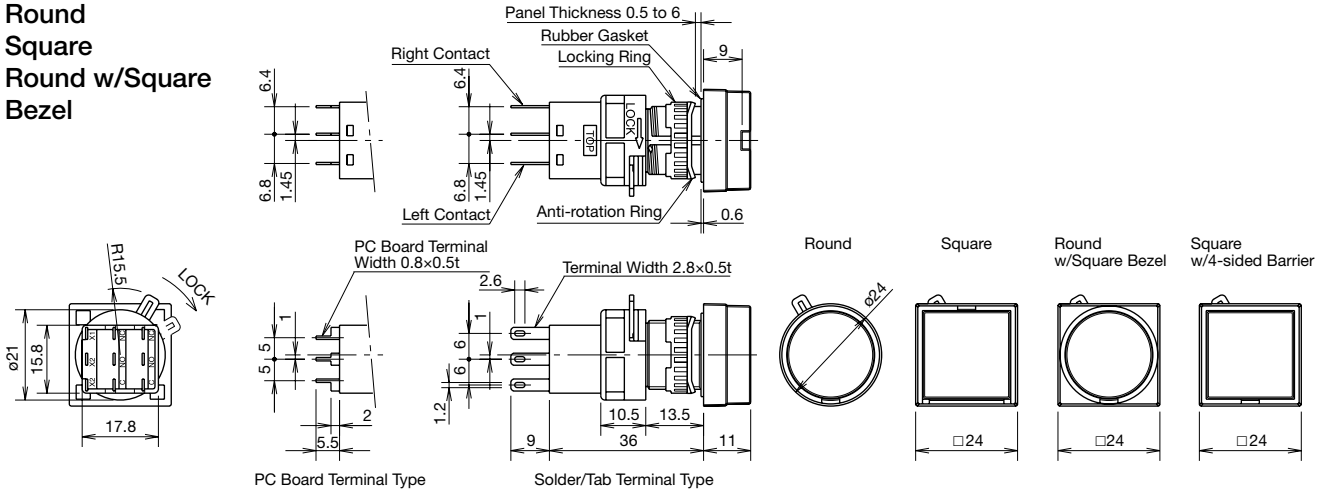

Mushroom

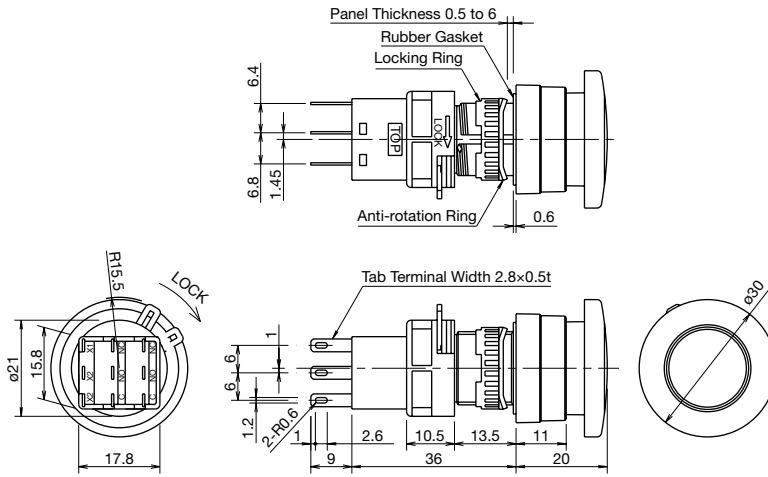

Mounting Hole Layout
Mounting Centers

Round
Square
Round w/Square Bezel

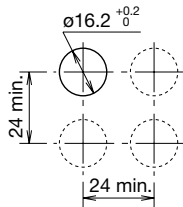

PC Board Drilling Layout
(Bottom View)

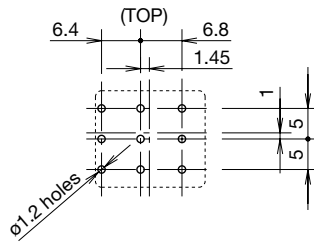

• See Single Board Mounting on page 24 for details about PC boards.

Terminal Arrangement
(Bottom View)

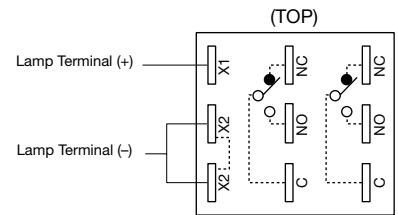

• SPDT has C, NO, and NC on the right only.
• X2 and X2 are wired internally.



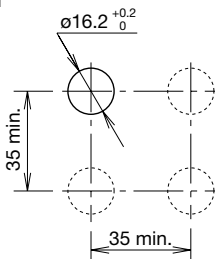

Mushroom



Note: Determine mounting centers to ensure easy operation.





HA1P / HA2P / HA3P / HA4P Pilot Lights

W/Removable Contact Block

Shape	Operating Voltage	Part No.		② Illumination Color Code
		Solder/Tab Terminal	PC Board Terminal	
Round HA1P  Marking plate size: ø18.4mm Engraving area: ø16.8mm (Depth: 0.5mm max.)	5V DC ±5%	HA1P-1C01②	HA1P-1C01V②	Specify a color code in place of ② in the Part No. A: amber G: green PW: pure white R: red S: blue Y: yellow
	12V AC/DC ±10%	HA1P-1C03②	HA1P-1C03V②	
	24V AC/DC ±10%	HA1P-1C04②	HA1P-1C04V②	
Square HA2P  Marking plate size: □18.4mm Engraving area: □16.4mm (Depth: 0.5mm max.)	5V DC ±5%	HA2P-1C01②	HA2P-1C01V②	
	12V AC/DC ±10%	HA2P-1C03②	HA2P-1C03V②	
	24V AC/DC ±10%	HA2P-1C04②	HA2P-1C04V②	
Round w/Square Bezel HA3P  Marking plate size: ø18.4mm Engraving area: ø16.8mm (Depth: 0.5mm max.)	5V DC ±5%	HA3P-1C01②	HA3P-1C01V②	
	12V AC/DC ±10%	HA3P-1C03②	HA3P-1C03V②	
	24V AC/DC ±10%	HA3P-1C04②	HA3P-1C04V②	
Square w/Four-sided Barrier HA4P  Marking plate size: □18.4mm Engraving area: □16.4mm (Depth: 0.5mm max.)	5V DC ±5%	HA4P-1C01②	HA4P-1C01V②	
	12V AC/DC ±10%	HA4P-1C03②	HA4P-1C03V②	
	24V AC/DC ±10%	HA4P-1C04②	HA4P-1C04V②	

- See page 6 for dimensions. • See page 24 for marking plate size and engraving area.
- One LED lamp is installed in an illuminated pilot light.

Unibody

Shape	Operating Voltage	Part No.		② Illumination Color Code
		Solder/Tab Terminal	PC Board Terminal	
Round HA1P  Marking plate size: ø18.4mm Engraving area: ø16.8mm (Depth: 0.5mm max.)	5V DC ±5%	HA1P-11②	—	Specify a color code in place of ② in the Part No. A: amber G: green PW: pure white R: red S: blue Y: yellow
	12V AC/DC ±10%	HA1P-13②	—	
	24V AC/DC ±10%	HA1P-14②	—	
Square HA2P  Marking plate size: □18.4mm Engraving area: □16.4mm (Depth: 0.5mm max.)	5V DC ±5%	HA2P-11②	—	
	12V AC/DC ±10%	HA2P-13②	—	
	24V AC/DC ±10%	HA2P-14②	—	
Round w/Square Bezel HA3P  Marking plate size: ø18.4mm Engraving area: ø16.8mm (Depth: 0.5mm max.)	5V DC ±5%	HA3P-11②	—	
	12V AC/DC ±10%	HA3P-13②	—	
	24V AC/DC ±10%	HA3P-14②	—	
Square w/Four-sided Barrier HA4P  Marking plate size: □18.4mm Engraving area: □16.4mm (Depth: 0.5mm max.)	5V DC ±5%	HA4P-11②	—	
	12V AC/DC ±10%	HA4P-13②	—	
	24V AC/DC ±10%	HA4P-14②	—	

- See page 6 for dimensions. • See page 24 for marking plate size and engraving area.
- One LED lamp is installed in an illuminated pilot light.

Dimensions

All dimensions in mm.

W/Removable Contact Block

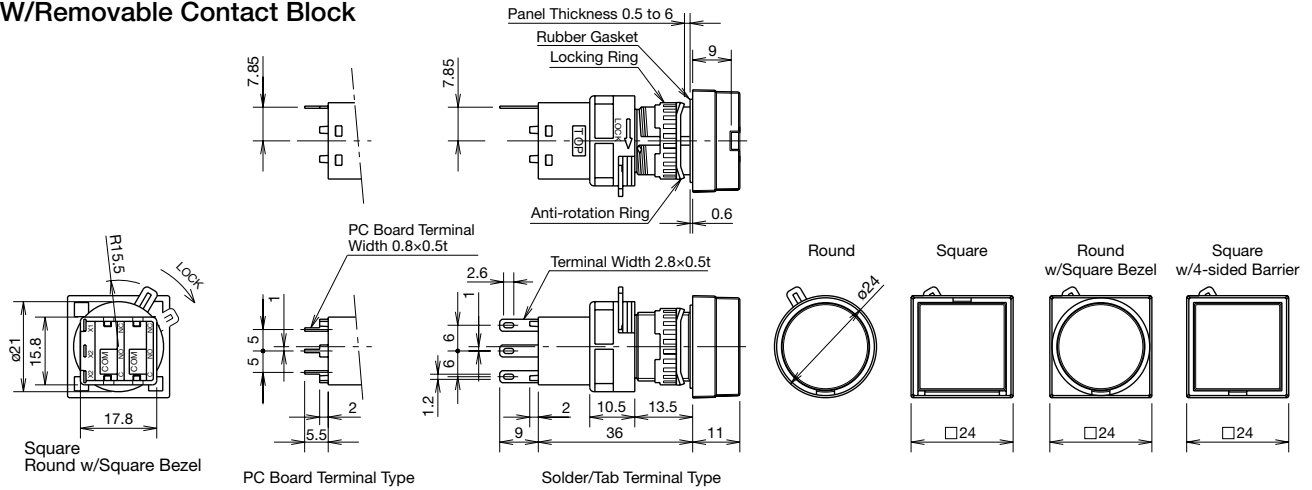

Unibody

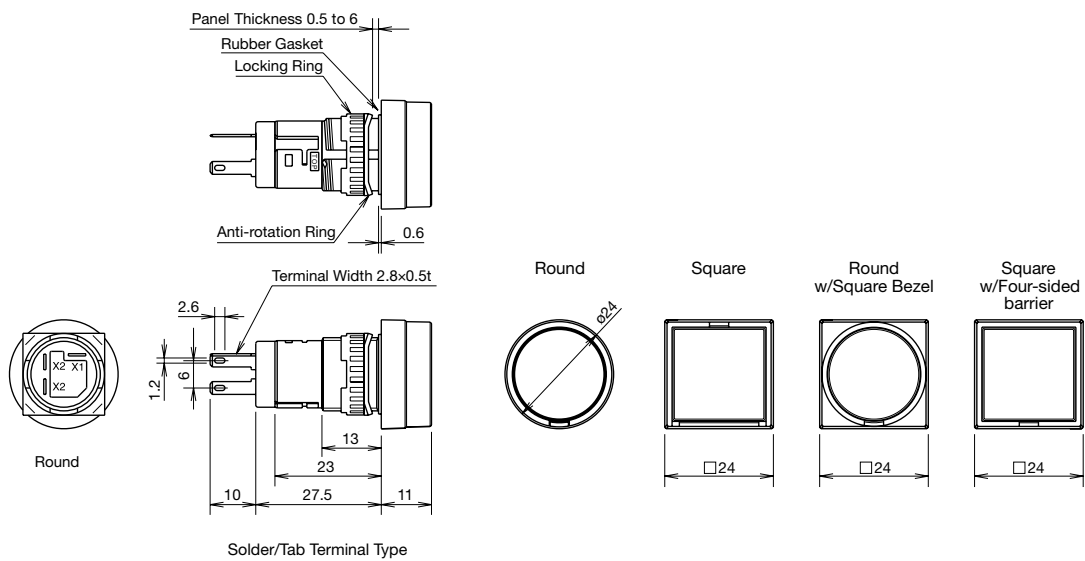

Mounting Hole Layout
Mounting Centers

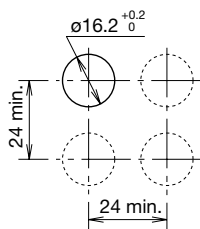

PC Board Drilling Layout
(Bottom View)

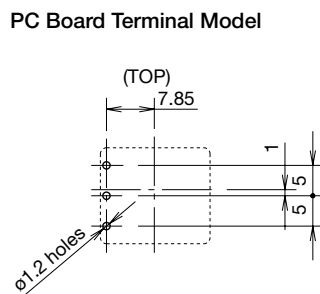

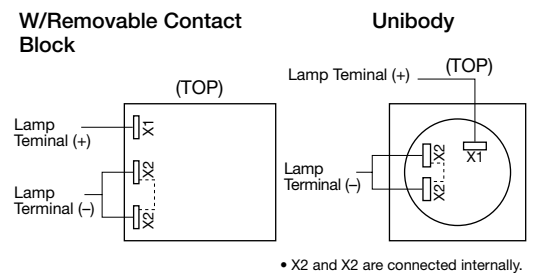

• See Single Board Mounting on page 24 for details about PC boards.

Terminal Arrangement
(Bottom View)







HA1B / HA2B / HA3B / HA4B Pushbuttons

Shape	Button Style	Operation	Contact	Part No.		Color Code ①②		
				Solder/Tab Terminal	PC Board Terminal			
Round HA1B-□1 	Button	Momentary	Gold	SPDT	HA1B-M1C1①	HA1B-M1C1V①	B: black G: green R: red S: blue W: white Y: yellow	
				DPDT	HA1B-M1C2①	HA1B-M1C2V①		
			Silver	SPDT	HA1B-M1C5①	—		
		DPDT		HA1B-M1C6①	—			
		Maintained	Gold	SPDT	HA1B-A1C1①	HA1B-A1C1V①		
				DPDT	HA1B-A1C2①	HA1B-A1C2V①		
	Silver		SPDT	HA1B-A1C5①	—			
		DPDT	HA1B-A1C6①	—				
	Illumination Lens	Momentary	Gold	SPDT	HA1B-M1C1L②	HA1B-M1C1VL②	A: amber G: green R: red S: blue W: white Y: yellow	
				DPDT	HA1B-M1C2L②	HA1B-M1C2VL②		
			Silver	SPDT	HA1B-M1C5L②	—		
		DPDT		HA1B-M1C6L②	—			
		Maintained	Gold	SPDT	HA1B-A1C1L②	HA1B-A1C1VL②		
				DPDT	HA1B-A1C2L②	HA1B-A1C2VL②		
	Silver		SPDT	HA1B-A1C5L②	—			
		DPDT	HA1B-A1C6L②	—				
	Square HA2B-□1 	Button	Momentary	Gold	SPDT	HA2B-M1C1①	HA2B-M1C1V①	B: black G: green R: red S: blue W: white Y: yellow
					DPDT	HA2B-M1C2①	HA2B-M1C2V①	
Silver				SPDT	HA2B-M1C5①	—		
			DPDT	HA2B-M1C6①	—			
Maintained			Gold	SPDT	HA2B-A1C1①	HA2B-A1C1V①		
				DPDT	HA2B-A1C2①	HA2B-A1C2V①		
		Silver	SPDT	HA2B-A1C5①	—			
DPDT			HA2B-A1C6①	—				
Illumination Lens		Momentary	Gold	SPDT	HA2B-M1C1L②	HA2B-M1C1VL②	A: amber G: green R: red S: blue W: white Y: yellow	
				DPDT	HA2B-M1C2L②	HA2B-M1C2VL②		
			Silver	SPDT	HA2B-M1C5L②	—		
		DPDT		HA2B-M1C6L②	—			
		Maintained	Gold	SPDT	HA2B-A1C1L②	HA2B-A1C1VL②		
				DPDT	HA2B-A1C2L②	HA2B-A1C2VL②		
Silver			SPDT	HA2B-A1C5L②	—			
		DPDT	HA2B-A1C6L②	—				
Round w/Square Bezel HA3B-□1 		Button	Momentary	Gold	SPDT	HA3B-M1C1①	HA3B-M1C1V①	B: black G: green R: red S: blue W: white Y: yellow
					DPDT	HA3B-M1C2①	HA3B-M1C2V①	
	Silver			SPDT	HA3B-M1C5①	—		
			DPDT	HA3B-M1C6①	—			
	Maintained		Gold	SPDT	HA3B-A1C1①	HA3B-A1C1V①		
				DPDT	HA3B-A1C2①	HA3B-A1C2V①		
		Silver	SPDT	HA3B-A1C5①	—			
	DPDT		HA3B-A1C6①	—				
	Illumination Lens	Momentary	Gold	SPDT	HA3B-M1C1L②	HA3B-M1C1VL②	A: amber G: green R: red S: blue W: white Y: yellow	
				DPDT	HA3B-M1C2L②	HA3B-M1C2VL②		
			Silver	SPDT	HA3B-M1C5L②	—		
		DPDT		HA3B-M1C6L②	—			
		Maintained	Gold	SPDT	HA3B-A1C1L②	HA3B-A1C1VL②		
				DPDT	HA3B-A1C2L②	HA3B-A1C2VL②		
	Silver		SPDT	HA3B-A1C5L②	—			
		DPDT	HA3B-A1C6L②	—				
	Square w/Four-sided Barrier HA4B-M1 	Button	Momentary	Gold	SPDT	HA4B-M1C1①	HA4B-M1C1V①	B: black G: green R: red S: blue W: white Y: yellow
					DPDT	HA4B-M1C2①	HA4B-M1C2V①	
Silver				SPDT	HA4B-M1C5①	—		
		DPDT	HA4B-M1C6①	—				
Illumination Lens		Maintained	Gold	SPDT	HA4B-M1C1L②	HA4B-M1C1VL②	A: amber G: green R: red S: blue W: white Y: yellow	
				DPDT	HA4B-M1C2L②	HA4B-M1C2VL②		
	Silver		SPDT	HA4B-M1C5L②	—			
DPDT		HA4B-M1C6L②	—					

- Specify a color code in place of ① or ② in the Part No. • For dimensions, see page 9.
- Illuminated lenses cannot be installed on button type pushbuttons.
- Black lens type is available for illumination lens type (not CCC approved). Clear lens and black marking plate are used. To specify, insert B in place of ② in the part number. Example: HA1B-M1C2LB.

HA1B / HA2B / HA3B / HA4B Pushbuttons

Shape	Button Style	Operation	Contact	Part No.		Color Code ①		
				Solder/Tab Terminal	PC Board Terminal			
Extended Round HA1B-□2  Square HA2B-□2  Round w/Square Bezel HA3B-□2  Square w/Four-sided Barrier HA4B-M2 	Button	Momentary	Gold	SPDT	HA1B-M2C1①	HA1B-M2C1V①	B: black G: green R: red S: blue W: white Y: yellow	
				DPDT	HA1B-M2C2①	HA1B-M2C2V①		
			Silver	SPDT	HA1B-M2C5①	—		
				DPDT	HA1B-M2C6①	—		
		Maintained	Gold	SPDT	HA1B-A2C1①	HA1B-A2C1V①		
				DPDT	HA1B-A2C2①	HA1B-A2C2V①		
			Silver	SPDT	HA1B-A2C5①	—		
				DPDT	HA1B-A2C6①	—		
		Momentary	Gold	SPDT	HA2B-M2C1①	HA2B-M2C1V①		
				DPDT	HA2B-M2C2①	HA2B-M2C2V①		
			Silver	SPDT	HA2B-M2C5①	—		
				DPDT	HA2B-M2C6①	—		
			Maintained	Gold	SPDT	HA2B-A2C1①		HA2B-A2C1V①
					DPDT	HA2B-A2C2①		HA2B-A2C2V①
				Silver	SPDT	HA2B-A2C5①		—
					DPDT	HA2B-A2C6①		—
Momentary	Gold	SPDT	HA3B-M2C1①	HA3B-M2C1V①				
		DPDT	HA3B-M2C2①	HA3B-M2C2V①				
	Silver	SPDT	HA3B-M2C5①	—				
		DPDT	HA3B-M2C6①	—				
	Maintained	Gold	SPDT	HA3B-A2C1①	HA3B-A2C1V①			
			DPDT	HA3B-A2C2①	HA3B-A2C2V①			
		Silver	SPDT	HA3B-A2C5①	—			
			DPDT	HA3B-A2C6①	—			
Momentary	Gold	SPDT	HA4B-M2C1①	HA4B-M2C1V①				
		DPDT	HA4B-M2C2①	HA4B-M2C2V①				
	Silver	SPDT	HA4B-M2C5①	—				
		DPDT	HA4B-M2C6①	—				
	Momentary	Gold	SPDT	HA1B-M3C1①	HA1B-M3C1V①			
			DPDT	HA1B-M3C2①	HA1B-M3C2V①			
		Silver	SPDT	HA1B-M3C5①	—			
			DPDT	HA1B-M3C6①	—			
Maintained		Gold	SPDT	HA1B-A3C1①	HA1B-A3C1V①			
			DPDT	HA1B-A3C2①	HA1B-A3C2V①			
		Silver	SPDT	HA1B-A3C5①	—			
			DPDT	HA1B-A3C6①	—			
ø30mm Mushroom								

- Specify a color code in place of ① in the Part No.
- For dimensions, see page 9.

Dimensions

All dimensions in mm.

Flush

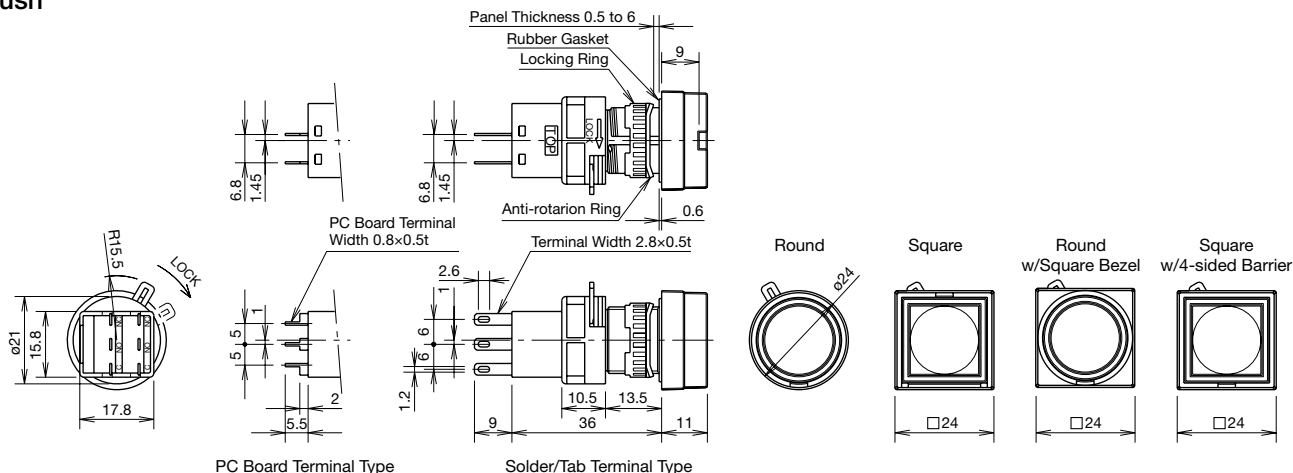

Extended

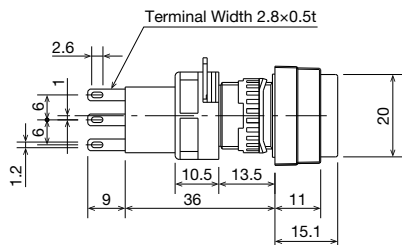

ø30mm Mushroom

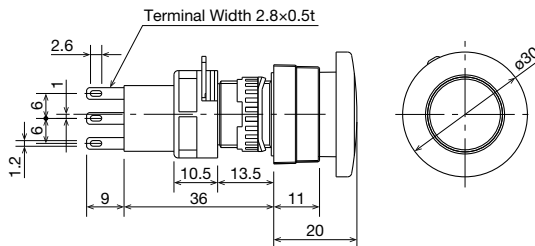

Mounting Hole Layout
Mounting Centers

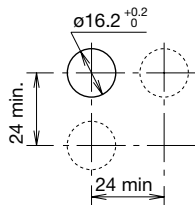

* 35 min. for mushroom type

PC Board Drilling Layout
(Bottom View)

PC Board Terminal Model

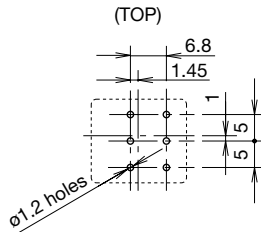

Terminal Arrangement
(Bottom View)

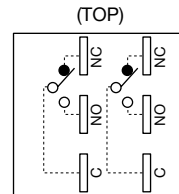







• SPDT has C, NO, and NC on the right only.

Note: Determine mounting centers to ensure easy operation.



















• See Single Board Mounting on page 24 for details about PC boards.

HA1S / HA3S Selector Switches

Shape	Operator Position		Operation	Contact		Part No.	
						Solder/Tab Terminal	PC Board Terminal
Round HA1S 	90° 2-position	Maintained		Gold	SPDT	HA1S-2C1	HA1S-2C1V
					DPDT	HA1S-2C2	HA1S-2C2V
				Silver	SPDT	HA1S-2C5	—
		DPDT	HA1S-2C6		—		
		Spring return from right	Gold	SPDT	HA1S-21C1	HA1S-21C1V	
				DPDT	HA1S-21C2	HA1S-21C2V	
	Silver		SPDT	HA1S-21C5	—		
		DPDT	HA1S-21C6	—			
	45° 3-position	Maintained		Gold	DPDT	HA1S-3C2	HA1S-3C2V
					Silver	DPDT	HA1S-3C6
		Spring return from right	Gold	DPDT	HA1S-31C2	HA1S-31C2V	
				Silver	DPDT	HA1S-31C6	—
Spring return from left		Gold	DPDT	HA1S-32C2	HA1S-32C2V		
			Silver	DPDT	HA1S-32C6	—	
Spring return two-way	Gold	DPDT	HA1S-33C2	HA1S-33C2V			
		Silver	DPDT	HA1S-33C6	—		
Round w/Square Bezel HA3S 	90° 2-position	Maintained		Gold	SPDT	HA3S-2C1	HA3S-2C1V
					DPDT	HA3S-2C2	HA3S-2C2V
				Silver	SPDT	HA3S-2C5	—
		DPDT	HA3S-2C6		—		
		Spring return from right	Gold	SPDT	HA3S-21C1	HA3S-21C1V	
				DPDT	HA3S-21C2	HA3S-21C2V	
	Silver		SPDT	HA3S-21C5	—		
		DPDT	HA3S-21C6	—			
	45° 3-position	Maintained		Gold	DPDT	HA3S-3C2	HA3S-3C2V
					Silver	DPDT	HA3S-3C6
		Spring return from right	Gold	DPDT	HA3S-31C2	HA3S-31C2V	
				Silver	DPDT	HA3S-31C6	—
Spring return from left		Gold	DPDT	HA3S-32C2	HA3S-32C2V		
			Silver	DPDT	HA3S-32C6	—	
Spring return two-way	Gold	DPDT	HA3S-33C2	HA3S-33C2V			
		Silver	DPDT	HA3S-33C6	—		

- Bezel: black
- Knob: black with white indicator
- See page 11 for dimensions.

Contact Operation

Operator Position & Contact Operation (Top View)					
Positions		Contact	↙ Left	↑ Center	↘ Right
90° 2-position	 Maintained  Spring return from right	SPDT		—	
		DPDT	 Left Contact  Right Contact	—	 Left Contact  Right Contact
45° 3-position	 Maintained  Spring return from right  Spring return from left  Spring return two-way	DPDT	 Left Contact  Right Contact	 Left Contact  Right Contact	 Left Contact  Right Contact

Dimensions

All dimensions in mm.

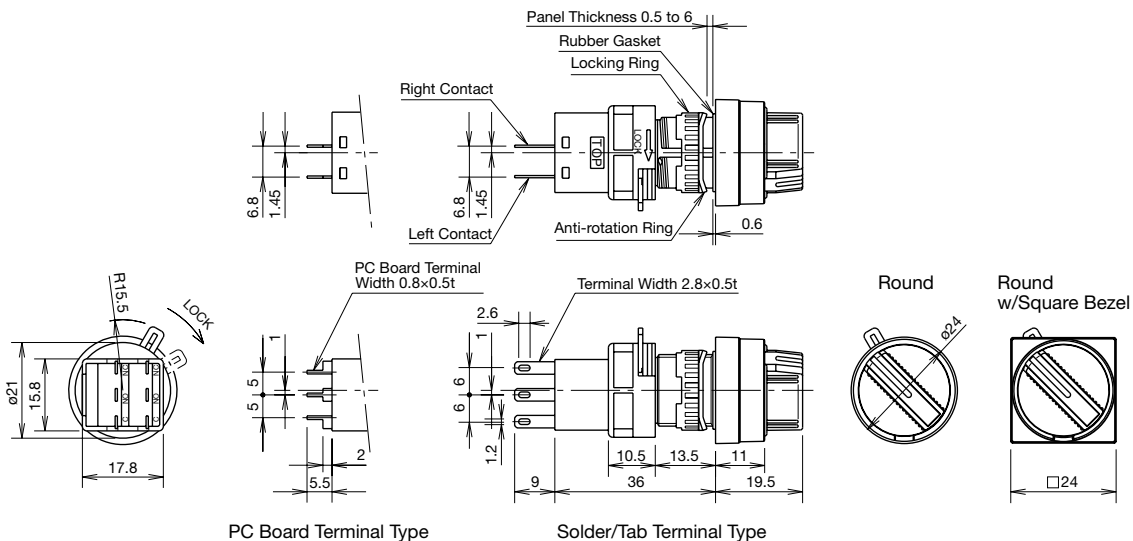

Mounting Hole Layout
 Mounting Centers

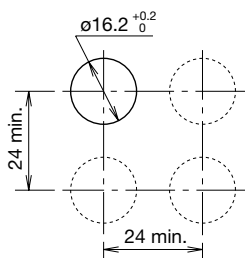

Note: Determine mounting centers to ensure easy operation.

PC Board Drilling Layout
 (Bottom View)

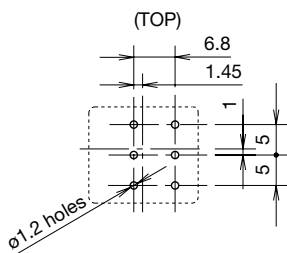





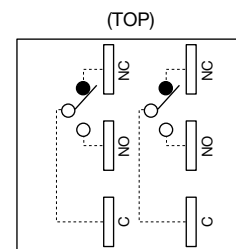









• See Single Board Mounting on page 24 for details about PC boards.

Terminal Arrangement
 (Bottom View)













• SPDT has C, NO, and NC on the right only.

HA1K Key Selector Switches

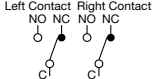
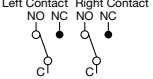

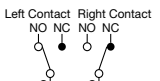
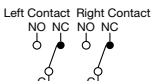
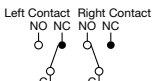















Shape	Operator Position		Keys Retained at ●	Contact	Part No.					
					Solder/Tab Terminal	PC Board Terminal				
Round HA1K 	90° 2-position	Maintained	A 	Gold	SPDT	HA1K-2C1A	HA1K-2C1VA			
				Silver	DPDT	HA1K-2C2A	HA1K-2C2VA			
			B 	Gold	SPDT	HA1K-2C1B	HA1K-2C1VB			
				Silver	DPDT	HA1K-2C2B	HA1K-2C2VB			
			C 	Gold	SPDT	HA1K-2C1C	HA1K-2C1VC			
				Silver	DPDT	HA1K-2C2C	HA1K-2C2VC			
		Spring return from right	B 	Gold	SPDT	HA1K-21C1B	HA1K-21C1VB			
				Silver	DPDT	HA1K-21C2B	HA1K-21C2VB			
				Gold	SPDT	HA1K-21C5B	—			
				Silver	DPDT	HA1K-21C6B	—			
				45° 3-position	Maintained	A 	Gold	DPDT	HA1K-3C2A	HA1K-3C2VA
							Silver	DPDT	HA1K-3C6A	—
	B 	Gold	DPDT			HA1K-3C2B	HA1K-3C2VB			
		Silver	DPDT			HA1K-3C6B	—			
	C 	Gold	DPDT			HA1K-3C2C	HA1K-3C2VC			
		Silver	DPDT			HA1K-3C6C	—			
	D 	Gold	DPDT			HA1K-3C2D	HA1K-3C2VD			
		Silver	DPDT			HA1K-3C6D	—			
	Spring return from right	B 	Gold		DPDT	HA1K-31C2B	HA1K-31C2VB			
			Silver		DPDT	HA1K-31C6B	—			
			D 		Gold	DPDT	HA1K-31C2D	HA1K-31C2VD		
					Silver	DPDT	HA1K-31C6D	—		
	Spring return from left	C 	Gold	DPDT	HA1K-32C2C	HA1K-32C2VC				
			Silver	DPDT	HA1K-32C6C	—				
			D 	Gold	DPDT	HA1K-32C2D	HA1K-32C2VD			
				Silver	DPDT	HA1K-32C6D	—			
		H 	Gold	DPDT	HA1K-32C2H	HA1K-32C2VH				
			Silver	DPDT	HA1K-32C6H	—				
			Spring return two-way	D 	Gold	DPDT	HA1K-33C2D	HA1K-33C2VD		
					Silver	DPDT	HA1K-33C6D	—		

- Two keys are supplied.
- The front of key cylinder is made of black plastic.
- See page 14 for dimensions.
- Besides the standard key (key number 231), three other key numbers are available (2/3/5). To specify, add the key number in the part number as: HA1K-3C2A-2

Contact Operation











Operator Position & Contact Operation (Top View)					
Positions		Contact	↙ Left	↑ Center	↘ Right
90° 2-position	Maintained 	SPDT		—	
	Spring return from right 	DPDT		—	
45° 3-position	Maintained 	DPDT			
	Spring return from right 				
	Spring return from left 				
	Spring return two-way 				

HA3K Key Selector Switches

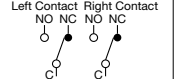
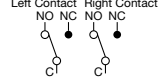
Shape	Operator Position	Keys Retained at ●	Contact	Part No.						
				Solder/Tab Terminal	PC Board Terminal					
Round w/Square Bezel HA3K 	90° 2-position	Maintained	A 	Gold	SPDT	HA3K-2C1A	HA3K-2C1VA			
				Silver	DPDT	HA3K-2C2A	HA3K-2C2VA			
			B 	Gold	SPDT	HA3K-2C1B	HA3K-2C1VB			
				Silver	DPDT	HA3K-2C2B	HA3K-2C2VB			
			C 	Gold	SPDT	HA3K-2C1C	HA3K-2C1VC			
				Silver	DPDT	HA3K-2C2C	HA3K-2C2VC			
		Spring return from right	B 	Gold	SPDT	HA3K-21C1B	HA3K-21C1VB			
				Silver	DPDT	HA3K-21C2B	HA3K-21C2VB			
				Gold	SPDT	HA3K-21C5B	—			
				Silver	DPDT	HA3K-21C6B	—			
				45° 3-position	Maintained	A 	Gold	DPDT	HA3K-3C2A	HA3K-3C2VA
							Silver	DPDT	HA3K-3C6A	—
	B 	Gold	DPDT			HA3K-3C2B	HA3K-3C2VB			
		Silver	DPDT			HA3K-3C6B	—			
	C 	Gold	DPDT			HA3K-3C2C	HA3K-3C2VC			
		Silver	DPDT			HA3K-3C6C	—			
	D 	Gold	DPDT			HA3K-3C2D	HA3K-3C2VD			
		Silver	DPDT			HA3K-3C6D	—			
	E 	Gold	DPDT			HA3K-3C2E	HA3K-3C2VE			
		Silver	DPDT			HA3K-3C6E	—			
	G 	Gold	DPDT			HA3K-3C2G	HA3K-3C2VG			
		Silver	DPDT			HA3K-3C6G	—			
	H 	Gold	DPDT	HA3K-3C2H	HA3K-3C2VH					
		Silver	DPDT	HA3K-3C6H	—					
	Spring return from right	B 	Gold	DPDT	HA3K-31C2B	HA3K-31C2VB				
			Silver	DPDT	HA3K-31C6B	—				
			D 	Gold	DPDT	HA3K-31C2D	HA3K-31C2VD			
				Silver	DPDT	HA3K-31C6D	—			
			G 	Gold	DPDT	HA3K-31C2G	HA3K-31C2VG			
				Silver	DPDT	HA3K-31C6G	—			
Spring return from left	C 	Gold	DPDT	HA3K-32C2C	HA3K-32C2VC					
		Silver	DPDT	HA3K-32C6C	—					
		D 	Gold	DPDT	HA3K-32C2D	HA3K-32C2VD				
			Silver	DPDT	HA3K-32C6D	—				
		H 	Gold	DPDT	HA3K-32C2H	HA3K-32C2VH				
			Silver	DPDT	HA3K-32C6H	—				
Spring return two-way	D 	Gold	DPDT	HA3K-33C2D	HA3K-33C2VD					
		Silver	DPDT	HA3K-33C6D	—					

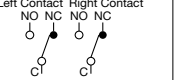
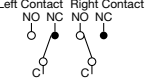
- Two keys are supplied.
- The front of key cylinder is made with black plastic.
- See page 14 for dimensions.
- Besides the standard key (key number 231), three other key numbers are available (2/3/5). To specify, add the key number in the part number as: HA3K-3C2A-2

Contact Operation

Operator Position & Contact Operation (Top View)					
Positions		Contact	↙ Left	↑ Center	↘ Right
90° 2-position	Maintained 	SPDT		—	
	Spring return from right 	DPDT		—	
45° 3-position	Maintained 	DPDT			
	Spring return from right 				
	Spring return from left 				
	Spring return two-way 				

Dimensions

All dimensions in mm.

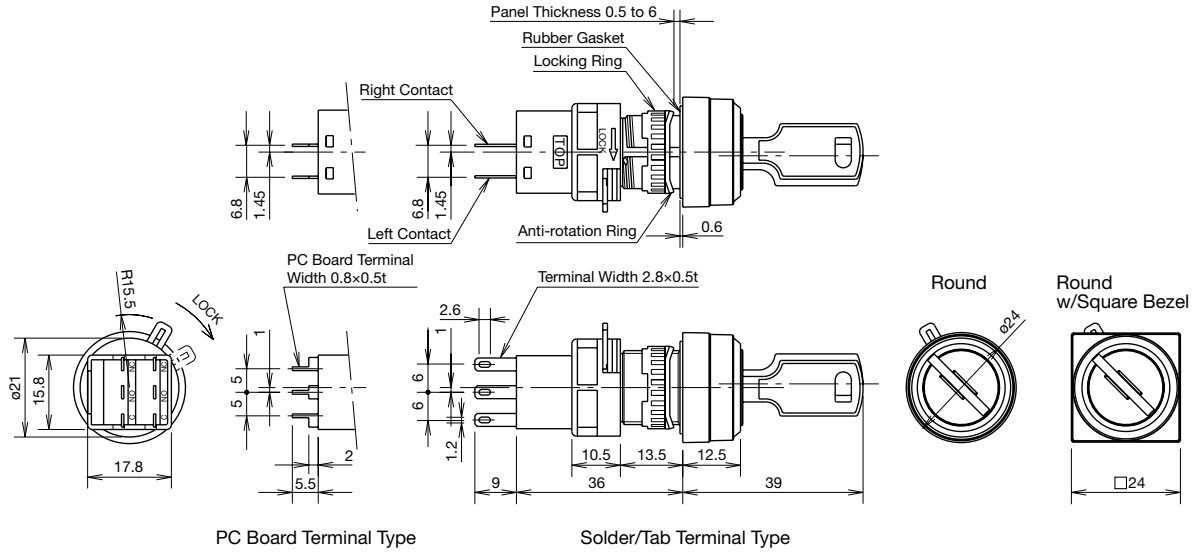

Mounting Hole Layout
Mounting Centers

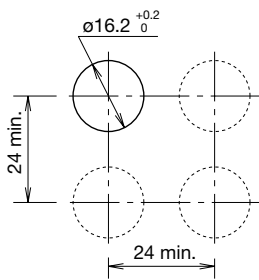

Note: Determine mounting centers to ensure easy operation.

PC Board Drilling Layout
(Bottom View)

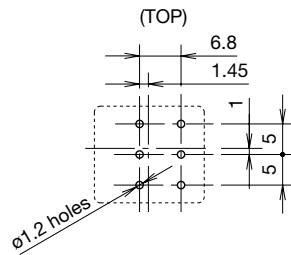



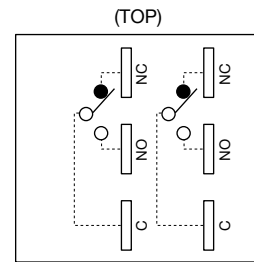

• See Single Board Mounting on page 24 for details about PC boards.

Terminal Arrangement
(Bottom View)



• SPDT has C, NO, and NC on the right only.









HA1F Illuminated Selector Switches

Shape	Operator Position		Contact Material	Operating Voltage	Contact	Part No.	Color Code ②
						Solder/Tab Terminal	
Round HA1F 	90° 2-position	Maintained 	Gold	5V DC ±5%	SPDT	HA1F-2C11②	Specify a lens color code in place of ② in the Part No. A: amber G: green PW: pure white R: red S: blue Y: yellow
				12V AC/DC ±10%	DPDT	HA1F-2C21②	
				24V AC/DC ±10%	SPDT	HA1F-2C13②	
				DPDT	HA1F-2C23②		
				SPDT	HA1F-2C14②		
				DPDT	HA1F-2C24②		
			Silver	5V DC ±5%	SPDT	HA1F-2C51②	
		12V AC/DC ±10%		DPDT	HA1F-2C61②		
		24V AC/DC ±10%		SPDT	HA1F-2C53②		
				DPDT	HA1F-2C63②		
				SPDT	HA1F-2C54②		
				DPDT	HA1F-2C64②		
		Spring return from right 	Gold	5V DC ±5%	SPDT	HA1F-21C11②	
	12V AC/DC ±10%			DPDT	HA1F-21C21②		
	24V AC/DC ±10%			SPDT	HA1F-21C13②		
			DPDT	HA1F-21C23②			
			SPDT	HA1F-21C14②			
			DPDT	HA1F-21C24②			
		Silver	5V DC ±5%	SPDT	HA1F-21C51②		
	12V AC/DC ±10%		DPDT	HA1F-21C61②			
	24V AC/DC ±10%		SPDT	HA1F-21C53②			
			DPDT	HA1F-21C63②			
			SPDT	HA1F-21C54②			
			DPDT	HA1F-21C64②			
45° 3-position	Maintained 	Gold	5V DC ±5%	DPDT	HA1F-3C21②		
			12V AC/DC ±10%	DPDT	HA1F-3C23②		
			24V AC/DC ±10%	DPDT	HA1F-3C24②		
			Silver	5V DC ±5%	DPDT	HA1F-3C61②	
		12V AC/DC ±10%		DPDT	HA1F-3C63②		
		24V AC/DC ±10%		DPDT	HA1F-3C64②		
	Spring return two-way 	Gold	5V DC ±5%	DPDT	HA1F-33C21②		
			12V AC/DC ±10%	DPDT	HA1F-33C23②		
			24V AC/DC ±10%	DPDT	HA1F-33C24②		
			Silver	5V DC ±5%	DPDT	HA1F-33C61②	
		12V AC/DC ±10%		DPDT	HA1F-33C63②		
		24V AC/DC ±10%		DPDT	HA1F-33C64②		



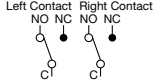

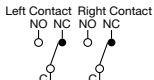
• See page 17 for dimensions.

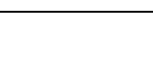
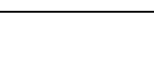
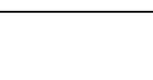
• One LED lamp is installed in illuminated selector switch.

Contact Operation

Operator Position & Contact Operation (Top View)					
Positions		Contact	↙ Left	↑ Center	↘ Right
90° 2-position	Maintained 	SPDT		—	
	Spring return from right 	DPDT		—	
45° 3-position	Maintained 	DPDT			
	Spring return two-way 				









HA3F Illuminated Selector Switches

Shape	Operator Position	Contact Material	Operating Voltage	Contact	Part No.		Color Code ②
					Solder/Tab Terminal		
Round w/Square Bezel HA3F 	90° 2-position	Maintained 	Gold	SPDT	HA3F-2C11②		Specify a lens color code in place of ② in the Part No. A: amber G: green PW: pure white R: red S: blue Y: yellow
					DPDT	HA3F-2C21②	
				12V AC/DC ±10%		SPDT	
			DPDT		HA3F-2C23②		
				24V AC/DC ±10%	SPDT	HA3F-2C14②	
			DPDT			HA3F-2C24②	
		Silver		5V DC ±5%	SPDT	HA3F-2C51②	
			DPDT			HA3F-2C61②	
				12V AC/DC ±10%	SPDT	HA3F-2C53②	
			DPDT			HA3F-2C63②	
				24V AC/DC ±10%	SPDT	HA3F-2C54②	
			DPDT			HA3F-2C64②	
	Spring return from right 	Gold		5V DC ±5%	SPDT	HA3F-21C11②	
			DPDT			HA3F-21C21②	
				12V AC/DC ±10%	SPDT	HA3F-21C13②	
			DPDT			HA3F-21C23②	
				24V AC/DC ±10%	SPDT	HA3F-21C14②	
			DPDT			HA3F-21C24②	
		Silver		5V DC ±5%	SPDT	HA3F-21C51②	
			DPDT			HA3F-21C61②	
				12V AC/DC ±10%	SPDT	HA3F-21C53②	
			DPDT			HA3F-21C63②	
				24V AC/DC ±10%	SPDT	HA3F-21C54②	
			DPDT			HA3F-21C64②	
45° 3-position	Maintained 	Gold		5V DC ±5%	DPDT	HA3F-3C21②	
			12V AC/DC ±10%			DPDT	HA3F-3C23②
				24V AC/DC ±10%	DPDT		HA3F-3C24②
		Silver	5V DC ±5%			DPDT	HA3F-3C61②
				12V AC/DC ±10%	DPDT		HA3F-3C63②
			24V AC/DC ±10%			DPDT	HA3F-3C64②
	Spring return two-way 	Gold		5V DC ±5%	DPDT		HA3F-33C21②
			12V AC/DC ±10%			DPDT	HA3F-33C23②
				24V AC/DC ±10%	DPDT		HA3F-33C24②
		Silver	5V DC ±5%			DPDT	HA3F-33C61②
				12V AC/DC ±10%	DPDT		HA3F-33C63②
			24V AC/DC ±10%			DPDT	HA3F-33C64②

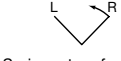
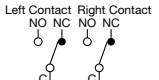
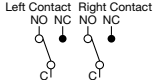
• See page 17 for dimensions.

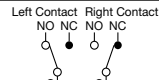
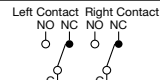
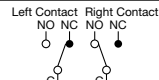
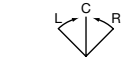
• One LED lamp is installed in illuminated selector switch.

Contact Operation

Operator Position & Contact Operation (Top View)					
Positions		Contact	↙ Left	↑ Center	↘ Right
90° 2-position	Maintained 	SPDT		—	
	Spring return from right 	DPDT		—	
45° 3-position	Maintained 	DPDT			
	Spring return two-way 				

Dimensions

All dimensions in mm.

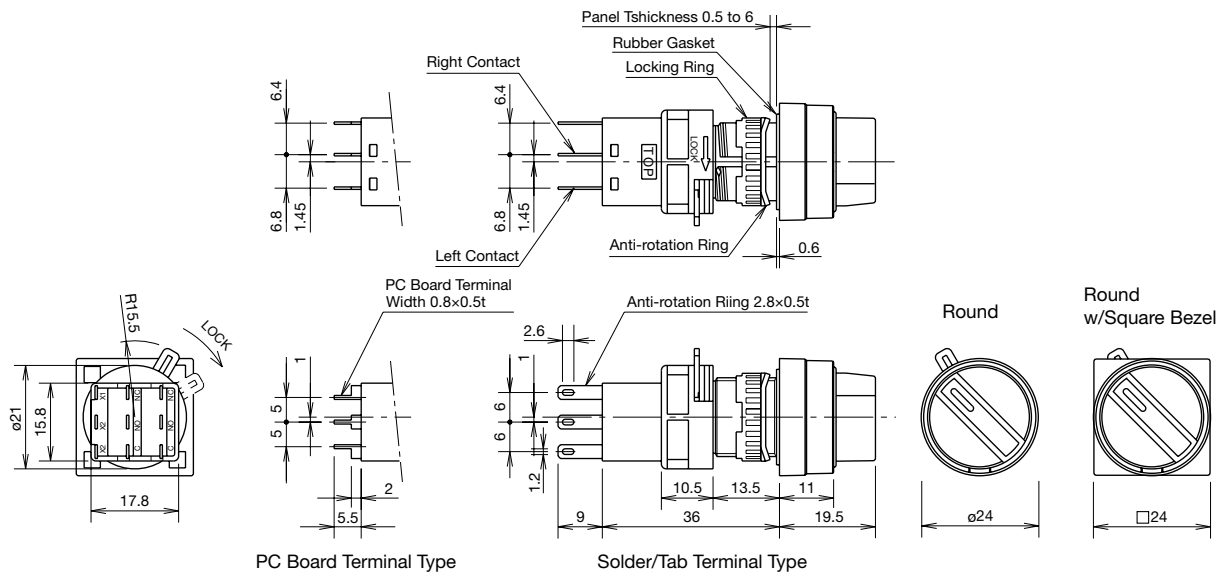

Mounting Hole Layout
Mounting Centers

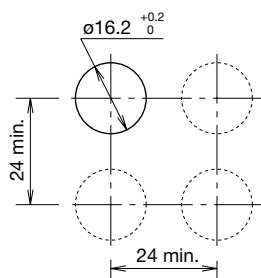

Note: Determine mounting centers to ensure easy operation.

PC Board Drilling Layout
(Bottom View)

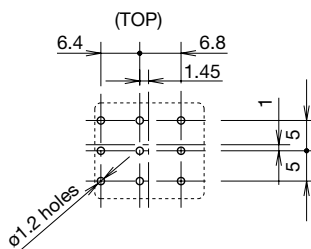





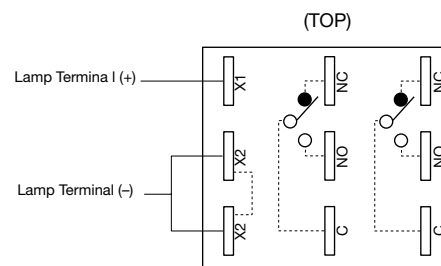





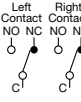

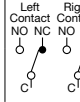
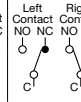



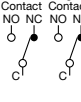
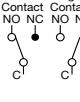
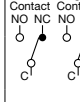
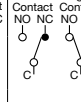
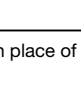
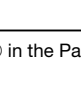
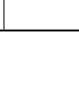
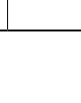



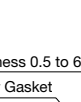

• See Single Board Mounting on page 24 for details about PC boards.

Terminal Arrangement
(Bottom View)

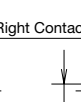
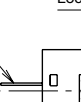

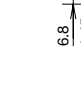
• SPDT has C, NO, and NC on the right only.
• X2 and X3 are wired internally.

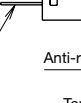
HA1R Selector Pushbuttons

Shape	Operator Position	Contact Operation						Contact Material	Contact	Part No. Terminal Style	Color Code ①		
		L		C		R							
		Normal	Push	Normal	Push	Normal	Push						
Round HA1R 	90° 2-position	Maintained			—	—			Gold	DPDT	Solder Tab Terminal HA1R-2C2①	B: black G: green R: red S: blue Y: yellow	
					—	—			Silver	DPDT	PC Board Terminal HA1R-2C2V①		
					—	—			Gold	DPDT	Solder Tab Terminal HA1R-3C2①		
				—	—			Silver	DPDT	PC Board Terminal HA1R-3C2V①			
	45° 3-position						Blocked			Gold	DPDT		Solder Tab Terminal HA1R-3C6①
							Blocked			Silver	DPDT		PC Board Terminal HA1R-3C6V①
					Blocked			Gold	DPDT	Solder Tab Terminal HA1R-3C6①			

• Specify a button color code in place of ① in the Part No.

Dimensions

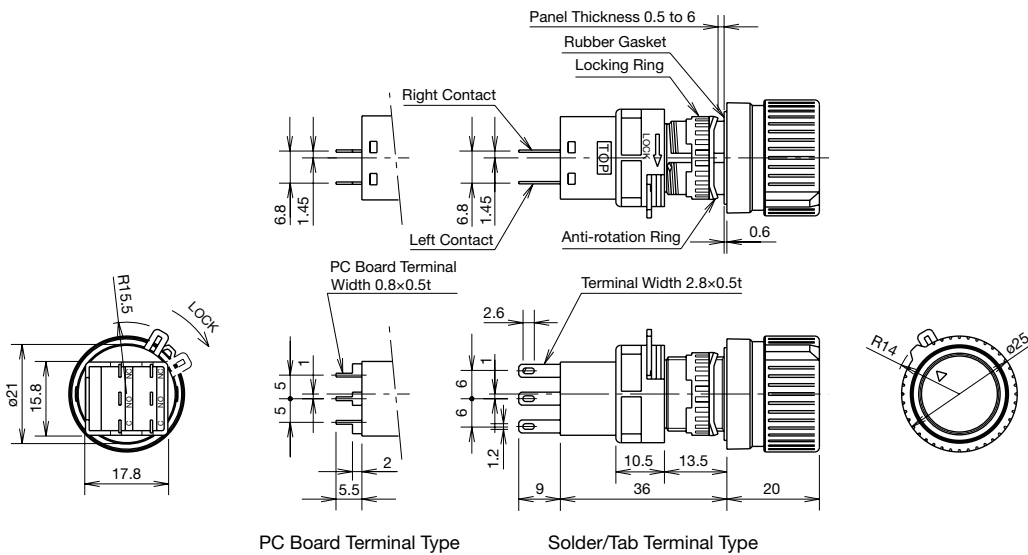

Mounting Hole Layout
 Mounting Centers

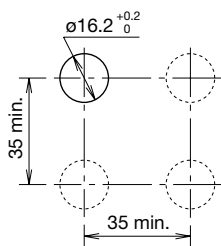

Note: Determine mounting centers to ensure easy operation.

PC Board Panel Cut-out
 (Bottom View)

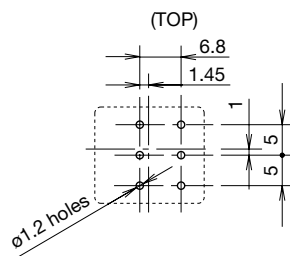





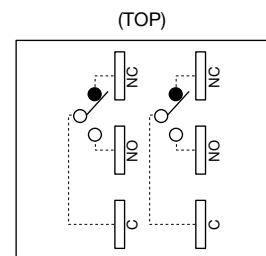



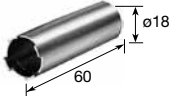

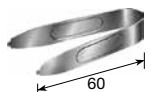
• See Single Board Mounting on page 24 for details about PC boards.



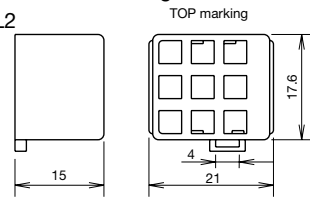
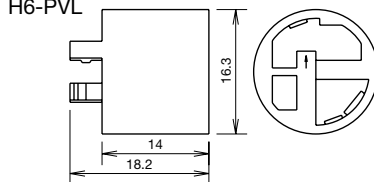

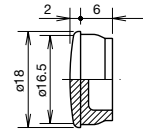
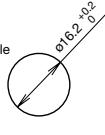

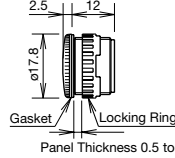
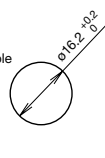









Terminal Arrangement
 (Bottom View)



Accessories

Shape	Material	Part No.	Ordering Part No.	Package Quantity	Remarks
	Metal (nickel-plated brass)	MT-001	MT-001	1	<ul style="list-style-type: none"> Used to tighten the locking ring when installing H6 into a panel. Tighten the locking ring to a torque of 0.88 N·m.
	Rubber (nitril)	OR-44	OR-44	1	<ul style="list-style-type: none"> Used to install and remove LED lamps.
	Stainless Steel	MT-101	MT-101	1	<ul style="list-style-type: none"> Used to remove the lens or buttons.
	Guard (Polyarylate) Base (polyacetal)	HA9Z-K1 HA9Z-KW1	HA9Z-K1 HA9Z-KW1	1 1	<ul style="list-style-type: none"> Degree of protection: IP65 Used to protect flush pushbuttons from inadvertent operation. 
	Nylon (white)	H6-VL2	H6-VL2PN10	10	<ul style="list-style-type: none"> Terminal cover is not attached and must be ordered separately. When wiring the terminals, insert the lead wires into the terminal cover holes before soldering.  
	Exclusive for Unibody Pilot Light	H6-PVL	H6-PVLPN10	10	
	Nitril Rubber (black)	AL-B6	AL-B6PN05	5	<ul style="list-style-type: none"> Degree of protection: IP65  
	Plug: Metal (diecast) Locking ring: plastic Gasket: nitril	AL-BM6	AL-BM6	1	<ul style="list-style-type: none"> Degree of protection: IP65 Tightening torque: 0.1 to 0.29 N·m  

Maintenance Parts

Shape		Specification	Part No.	Ordering Part No.	Package Quantity	Remarks	
Lens  ①  ②  ③	Round, Round w/Square Bezel	Polyarylate	HA9Z-L11②	HA9Z-L11②PN05	5	Specify a color code in place of ② in the Part No. A (amber), C (clear), G (green), R (red), S (blue), Y (yellow) Note: Use C (clear) lens for PW (pure white) illumination.	
	Square		HA9Z-L21②	HA9Z-L21②PN05			
	ø30mm Lens		HA9Z-L13②	HA9Z-L13②PN05			
Button  ①  ②  ③  ④  ⑤  ⑥  ⑦	Round Flush, Round w/Square Bezel	Polyacetal	HA9Z-B11①	HA9Z-B11①PN05	2	Specify a color code in place of ① in the Part No. B (black), G (green), R (red), S (blue), W (white), Y (yellow)	
	Square Flush		HA9Z-B21①	HA9Z-B21①PN05			
	Round Extended, Round Extended w/Square Bezel		HA9Z-B12①	HA9Z-B12①PN05			
	Square Extended		HA9Z-B22①	HA9Z-B22①PN05			
	ø30mm Button		HA9Z-B13①	HA9Z-B13①PN05			
	Selector Pushbutton		HA1A-R1①	HA1A-R1①PN02			
Marking Plate 	Round, Round w/Square Bezel	Acrylic	White	HA9Z-P1W	5	<ul style="list-style-type: none"> • HA9Z-P1W (engraving area: ø16.4 mm, engraving depth: 0.5 mm max.) • HA9Z-P2W (engraving area: □16.4 mm, engraving depth: 0.5 mm max.) 	
	Square		Black	HA9Z-P1B			HA9Z-P1BPN05
			White	HA9Z-P2W			HA9Z-P2WPN05
			Black	HA9Z-P2B			HA9Z-P2BPN05
Locking Ring 	For all types	Polyacetal	HA9Z-LN	HA9Z-LNPN10	10		
Anti-rotation Ring 	For all types except for HA1E	Stainless Steel	HA9Z-LP	HA9Z-LPPN10			
Lever Lock 	For all types except for collective mounting and HA1E	Polyacetal	HA9Z-LS	HA9Z-LSPN10	5	<ul style="list-style-type: none"> • Lever lock is not attached and must be ordered separately. • Yellow 	
Selector Color Insert 	For selector switch	Polyacetal	HA9Z-HC1①	HA9Z-HC1①PN05		Specify a color code in place of ① in the Part No. G (green), R (red), S (blue), W (white), Y (yellow)	
Spare Key 	For key selector switches	Nickel-plated Brass	KG9Z-SK-231	KG9Z-SK-231PN02	2	<ul style="list-style-type: none"> • Thickness: 2.0mm • Besides the standard key number (231), three other numbers (2, 3, 5) are available. Ordering part number: KG9Z-SK-2PN02 KG9Z-SK-3PN02 KG9Z-SK-5PN02	
Illuminated Selector Knob 	For illuminated selector switch	Polyarylate (w/water-proof gasket)	HA1A-F②	HA1A-F②	1	Specify a color code in place of ② in the Part No. A (amber), G (green), R (red), S (blue), W (white), Y (yellow) Note: Use W (white) knob for PW (pure white) illumination.	

LED Lamps

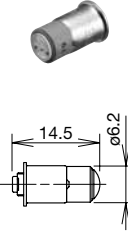
Dimension	Rated Voltage	Current Draw		Part No.	Ordering Part No.	② Illumination Color Code	Package Quantity	Base
		DC	AC					
	5V DC	8 mA (except S) 7m (S)	—	LFTD-5②	LFTD-5②	Specify a color code in place of ② in the Ordering Part No. A: amber G: green PW: pure white R: red S: blue	1	SX6S/8x5.4
					LFTD-5②PN10		10	
	6V AC/DC	7 mA (except S) 6m (S)	9 mA (A, R, S, W) 10 mA (G, PW)	LFTD-6②	LFTD-6②		1	
					LFTD-6②PN10		10	
	12V AC/DC	8 mA (except S) 7m (S)	9 mA (except S) 8m (S)	LFTD-1②	LFTD-1②		1	
					LFTD-1②PN10		10	
	24V AC/DC	8 mA (except S) 7m (S)	9 mA (except S) 8m (S)	LFTD-2②	LFTD-2②	1		
					LFTD-2②PN10	10		
Use a PW (pure white) LED lamp for yellow illumination.								

Transformer

Transformer	Rated Voltage	Operating Voltage Range	Part No.	Applicable LED Lamp
	100/110V AC	100/110V AC ±10%	TWR512	LFTD-2②
	200/220V AC	200/220V AC ±10%	TWR522	
	400/440V AC	400/440V AC ±10%	TWR542	

- Terminal covers are supplied with separate mounting type transformers.
- Connect only one LFTD LED to separate mounting type transformers.

Dimensions

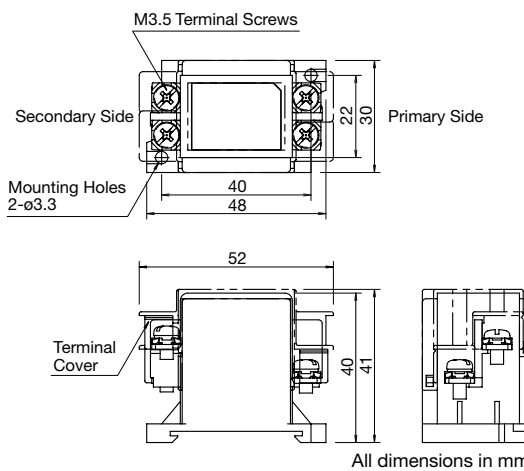

Specifications

Rated Voltage	100/110V AC, 200/220V AC, 400/440V AC (50/60 Hz)	
Power Consumption	2.4VA	
Rated Insulation Voltage	600V	
Insulation Resistance	100 MΩ minimum (500V DC megger)	
Dielectric Strength	2500V AC, 1 minute	
Standard Operating Condition	Operating Temperature	-30 to +60°C (no freezing)
	Relative Humidity	35 to 85% (no condensation)
Vibration Resistance	Operating Extremes	5 to 55 Hz, amplitude 0.5 mm
Shock Resistance	Damage Limits	1,000 m/s ² (100G)
Terminal Screw	M3.5	
Applicable Wire	2 mm ² maximum, 2 wires maximum	

Accessories

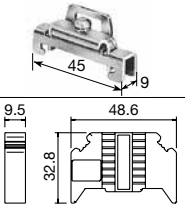
Description	Appearance	Description	Part No.	Ordering Part No.	Package Quantity
DIN Rail		Aluminum Weight: Approx. 200g	BAA1000	BAA1000PN10	10
		Steel Weight: Approx. 320g	BAP1000	BAP1000PN10	
End Clip		Steel Weight: Approx. 15g	BNL6	BNL6PN10	
		Plastic Weight: Approx. 15g	BC9Z-E/NS35N	BC9Z-E/NS35NPN10	

Dimensions

All dimensions in mm.

Terminal Cover

For W/removable Contact Block (H6-VL2)

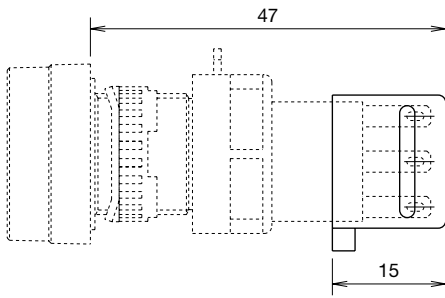

For Unibody (H6-PVL)

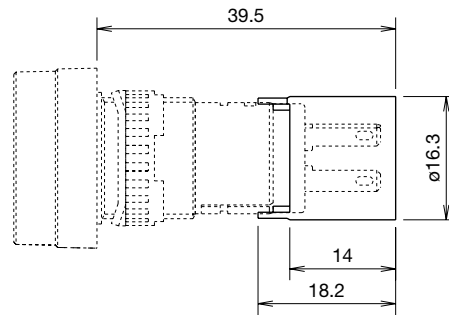

Switch Guard

For Flush Pushbuttons and Illuminated Pushbuttons

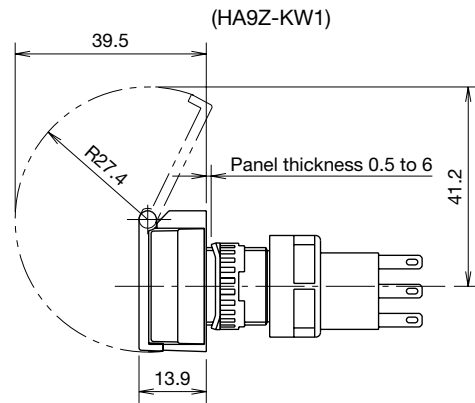
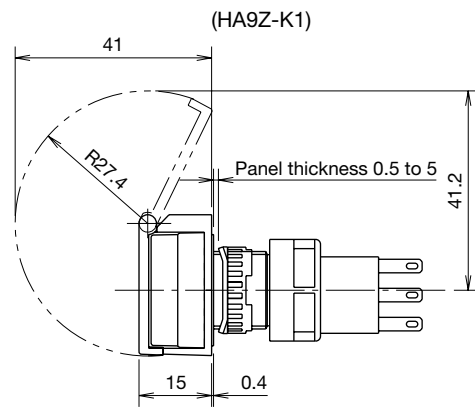
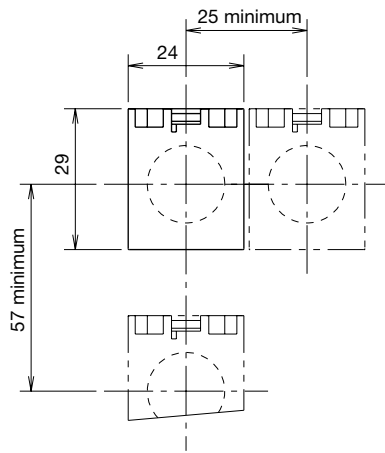

Safety Precautions

- Turn off the power to H6 series before installation, removal, wiring, maintenance, and inspection of the units. Failure to turn power off may cause electrical shocks or fire hazard.
- To avoid burning your hand, use the lamp holder when replacing lamps.
- For wiring, use wires of a proper gauge to meet voltage and current requirements. Improper soldering may cause overheating and create a fire hazard.

Instructions

Replacement of Lens and Marking Plate

Removing the Lens

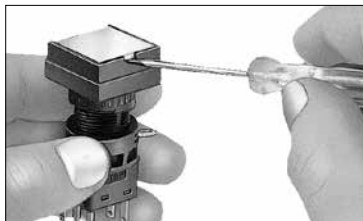

Removing the Marking Plate

Remove the marking plate by pushing the lens from the rear to disengage the latches between the lens and the lens holder, using the screwdriver as shown below.

Note: The translucent filter in the lens holder cannot be removed because this filter is sealed to make the unit waterproof.



Installing

For round lens types, place the marking plate on the lens holder with the projection engaged and press the lens onto the lens holder to engage the latches. For square lens types, insert the marking plate into the lens, and press the lens onto the holder to engage the latches.

Note: Make sure of correct orientation of the marking plate.

[Round Lens Type]

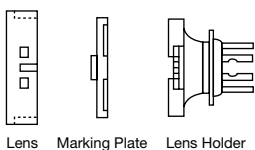

[Square Lens Type]

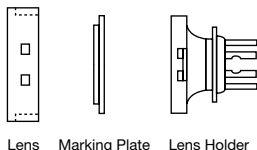

Replacement of Lamps

Lamps can be replaced using the lamp holder tool (OR-44) from the front of the panel, or by removing the contact block from the operator.

Removing the Lamp

1. Slip the lamp holder tool onto the lamp head. Then push slightly, and turn the lamp holder tool counterclockwise.



2. Push the bulb, and remove from the rear of the lamp holder.



Installing the Lamp

1. Insert the lamp into the lamp holder from the rear, and push in completely using the smaller end of the lamp holder tool.

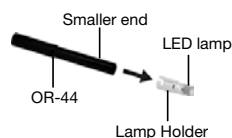

2. Hold the bulb with the lamp holder tool as shown below.

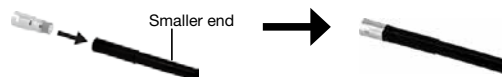

3. Place the insertion guide of the lamp holder and the TOP marking side or the groove in the operator unit in the same direction. Insert the lamp holder into the housing with the lamp holder tool. Then push the lamp lightly and turn it clockwise to install.

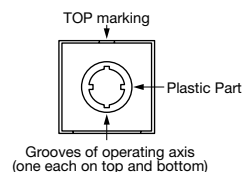

Panel Mounting

Remove the contact block from the operator. Insert the operator into the panel cut-out from the front, then install the contact block to the operator.

Removing the Contact Block

Turn the locking lever on the contact block in the direction opposite to the arrow on the housing. Then the contact block can be removed.



Installing the Contact Block

Insert the contact block with the TOP markings on the contact block and the operator placed in the same direction. Then lock the units, turning the locking lever in the direction of the arrow.

Notes for Mounting

Use the optional Ring Wrench (MT-001) to mount the operator onto a panel. Tightening torque should not exceed 0.88 N·m. Do not use pliers. Do not tighten with excessive force, otherwise the locking ring will be damaged.

Collective Mounting

As the locking lever can be turned easily from the rear of the units using a screwdriver, the contact blocks can be removed even when mounted collectively.

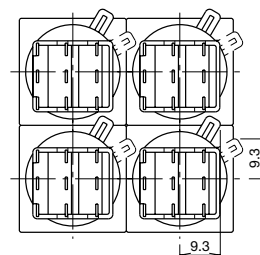

Instructions

Marking Plates and Films

For H6 series illuminated pushbuttons and pilot lights, legends and symbols can be engraved on marking plates, or printed mylar film can be inserted under the lens for labelling purposes.

Marking Plate and Marking Film Size

Lens	Round Lens (round, round w/square bezel)	Square Lens
Built-in Marking Plate	<p>• Engraving must be made on the engraving area within 0.5mm deep. • The marking plate is made of white acrylic resin.</p>	
Applicable Marking Film	<p>• Two 0.1mm-thick films or one 0.2mm-thick film can be installed in the lens. • Marking film is not included. • Recommended marking film: Polyester film</p>	

Insertion Order of Marking Plate and Film

[Round Lens Type]

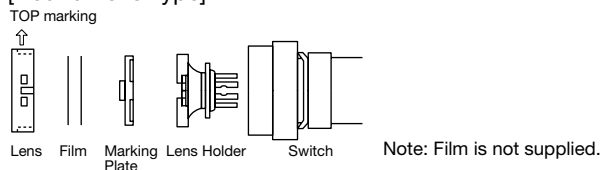

[Square Lens Type]

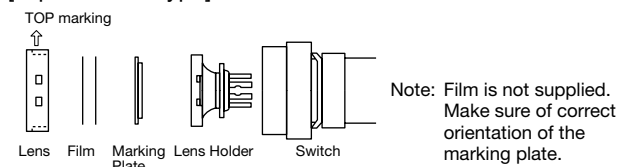

Wiring

- Solder the terminals at 350°C within 3 seconds using a 60W soldering iron. Sn-Ag-Cu type is recommended when using lead-free solder. When soldering, do not touch the H6 with the soldering iron. Also ensure that no tensile force is applied to the terminal. Do not bend the terminal or apply excessive force to the terminal.
- Use non-corrosive liquid flux.

Notes on Terminal Cover

Insert the terminal cover into the contact block with the TOP markings on the contact block and the terminal cover in the same direction.

Note: When wiring, insert the lead wires into the terminal cover holes before soldering.

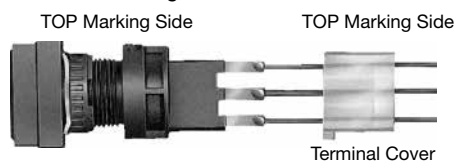

Connection

Positive-lock connector and easy-lock connector are applicable to tab terminals.

Recommended Connectors

Item	Positive-lock Connector (Tyco Electronics)		Easy-lock Connector (Nichifu Co., Ltd.)	
	Terminal	0.2 to 0.5 mm ²	175412-1	0.2 to 0.3 mm ²
	0.2 to 1.25 mm ²	174778-1	0.5 to 1.25 mm ²	OSS-62815F3
Housing	174779-1		NET1-28-1P	

Note: Positive-lock is a registered trademark of Tyco Electronics.

Single Board Mounting

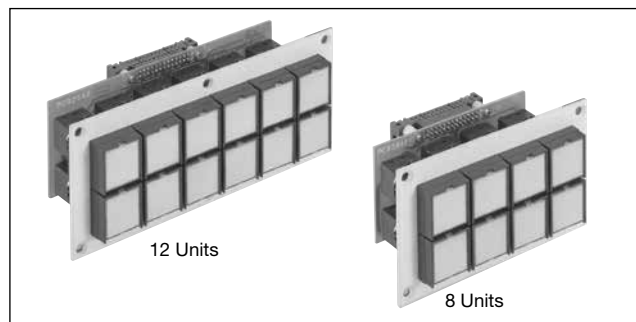

Mounting the PC board terminal type units on a PC board offers the following features.

Features

- Reduced installation labor, easy wiring, space saving, and standardization.
- Since the contact blocks on the PC board can be removed easily using a locking lever, the H6 series is easy to maintain.
- Because the H6 series requires no studs for fastening the unit to a PC board, special preparation of the control panel is not needed.

Notes for Designing PC board and Circuit

- Use 1.6-mm-thick glass epoxy PC board with drilled holes.
- Design a circuit so that the H6 series can operate within the rated voltage and current range. Make sure that inrush current and voltage do not exceed the rating.
- Minimum applicable load is 5V AC/DC, 1 mA on gold contacts. Applicable range is subject to the operating condition and load.
- Since the 2.8-mm-wide terminal touches the PC board as shown on the right, short circuit may occur with pattern lines. Design a circuit carefully to prevent short circuit.

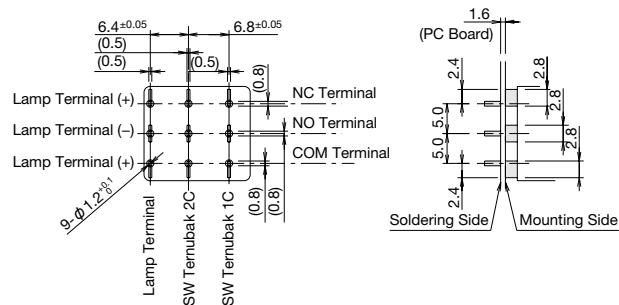

PC Board Drilling Layout

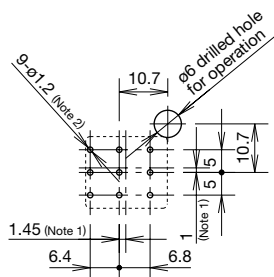

Note 1: When designing, note the alignment of centerlines of the contact blocks and centerlines of the operators.
 Note 2: The diameter of the terminal hole is 1.2 mm.

Installation and Removal of Contact Blocks

Turn the locking lever to install and remove the contact block on the PC board by using a screwdriver from a hole (ø6 mm) of the PC board.

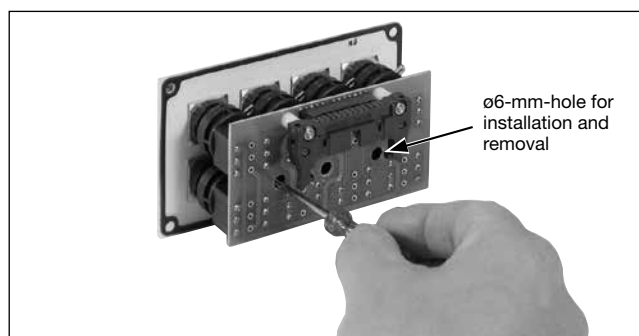

Hole diameter may vary to meet installation requirements. When the locking lever can be turned by using a screwdriver from the upper or right space, the holes are not necessary.

<Example>

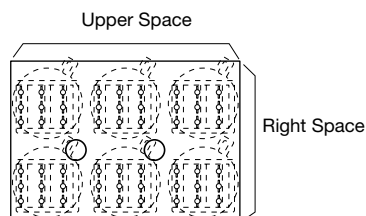

Mounting Holes and Assembly Procedure

• Drill mounting holes in the panel as shown below. When the units are mounted collectively, provide adequate clearance.

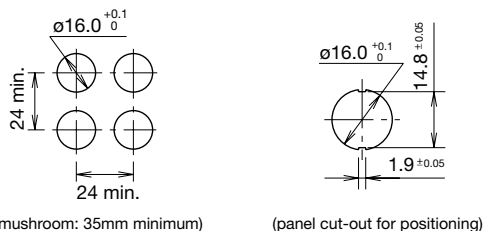

• Assembly Procedure

1. Install the operator to the operation panel.
 2. Insert the contact block to the operator from the rear.
 3. Turn the lock lever to lock the contact block.
 4. Insert the PC board to terminals and solder.
- Note 1: Make sure that each terminal is inserted into the PC board correctly.
 Note 2: Do not apply tensile force to the connector cable for extended period of time.
 Note 3: Do not expose the contact block to water.
 Note 4: Ensure to lock contact blocks when the contact blocks are installed on the operators.

Switchguard for Single Board Mounting



Part No. HA9Z-KW1

See page 22 for dimensions.

Note: H6 series with or without switchguard can be used on a single board, as the depth behind the panel to the PC board is the same.

Ordering Terms and Conditions

Thank you for using IDEC Products.

By purchasing products listed in our catalogs, datasheets, and the like (hereinafter referred to as "Catalogs") you agree to be bound by these terms and conditions. Please read and agree to the terms and conditions before placing your order.

1. Notes on contents of Catalogs

- (1) Rated values, performance values, and specification values of IDEC products listed in this Catalog are values acquired under respective conditions in independent testing, and do not guarantee values gained in combined conditions.
Also, durability varies depending on the usage environment and usage conditions.
- (2) Reference data and reference values listed in Catalogs are for reference purposes only, and do not guarantee that the product will always operate appropriately in that range.
- (3) The specifications / appearance and accessories of IDEC products listed in Catalogs are subject to change or termination of sales without notice, for improvement or other reasons.
- (4) The content of Catalogs is subject to change without notice.

2. Note on applications

- (1) If using IDEC products in combination with other products, confirm the applicable laws / regulations and standards.
Also, confirm that IDEC products are compatible with your systems, machines, devices, and the like by using under the actual conditions. IDEC shall bear no liability whatsoever regarding the compatibility with IDEC products.
- (2) The usage examples and application examples listed in Catalogs are for reference purposes only. Therefore, when introducing a product, confirm the performance and safety of the instruments, devices, and the like before use. Furthermore, regarding these examples, IDEC does not grant license to use IDEC products to you, and IDEC offers no warranties regarding the ownership of intellectual property rights or non-infringement upon the intellectual property rights of third parties.
- (3) When using IDEC products, be cautious when implementing the following.
 - i. Use of IDEC products with sufficient allowance for rating and performance
 - ii. Safety design, including redundant design and malfunction prevention design that prevents other danger and damage even in the event that an IDEC product fails
 - iii. Wiring and installation that ensures the IDEC product used in your system, machine, device, or the like can perform and function according to its specifications
- (4) Continuing to use an IDEC product even after the performance has deteriorated can result in abnormal heat, smoke, fires, and the like due to insulation deterioration or the like. Perform periodic maintenance for IDEC products and the systems, machines, devices, and the like in which they are used.
- (5) IDEC products are developed and manufactured as general-purpose products for general industrial products. They are not intended for use in the following applications, and in the event that you use an IDEC product for these applications, unless otherwise agreed upon between you and IDEC, IDEC shall provide no guarantees whatsoever regarding IDEC products.
 - i. Use in applications that require a high degree of safety, including nuclear power control equipment, transportation equipment (railroads / airplanes / ships / vehicles / vehicle instruments, etc.), equipment for use in outer space, elevating equipment, medical instruments, safety devices, or any other equipment, instruments, or the like that could endanger life or human health
 - ii. Use in applications that require a high degree of reliability, such as provision systems for gas / waterworks / electricity, etc., systems that operate continuously for 24 hours, and settlement systems
 - iii. Use in applications where the product may be handled or used deviating from the specifications or conditions / environment listed in the Catalogs, such as equipment used outdoors or applications in environments subject to chemical pollution or electromagnetic interference
If you would like to use IDEC products in the above applications, be sure to consult with an IDEC sales representative.

3. Inspections

We ask that you implement inspections for IDEC products you purchase without delay, as well as thoroughly keep in mind management/maintenance regarding handling of the product before and during the inspection.

4. Warranty

- (1) Warranty period
The warranty period for IDEC products shall be one (1) year after purchase or delivery to the specified location. However, this shall not apply in cases where there is a different specification in the Catalogs or there is another agreement in place between you and IDEC.
- (2) Warranty scope
Should a failure occur in an IDEC product during the above warranty period for reasons attributable to IDEC, then IDEC shall replace or repair that product, free of charge, at the purchase location / delivery location of the product, or an IDEC service base. However, failures caused by the following reasons shall be deemed outside the scope of this warranty.
 - i. The product was handled or used deviating from the conditions / environment listed in the Catalogs
 - ii. The failure was caused by reasons other than an IDEC product
 - iii. Modification or repair was performed by a party other than IDEC
 - iv. The failure was caused by a software program of a party other than IDEC
 - v. The product was used outside of its original purpose
 - vi. Replacement of maintenance parts, installation of accessories, or the like was not performed properly in accordance with the user's manual and Catalogs
 - vii. The failure could not have been predicted with the scientific and technical standards at the time when the product was shipped from IDEC
 - viii. The failure was due to other causes not attributable to IDEC (including cases of force majeure such as natural disasters and other disasters)Furthermore, the warranty described here refers to a warranty on the IDEC product as a unit, and damages induced by the failure of an IDEC product are excluded from this warranty.

5. Limitation of liability

The warranty listed in this Agreement is the full and complete warranty for IDEC products, and IDEC shall bear no liability whatsoever regarding special damages, indirect damages, incidental damages, or passive damages that occurred due to an IDEC product.

6. Service scope

The prices of IDEC products do not include the cost of services, such as dispatching technicians. Therefore, separate fees are required in the following cases.

- (1) Instructions for installation / adjustment and accompaniment at test operation (including creating application software and testing operation, etc.)
- (2) Maintenance inspections, adjustments, and repairs
- (3) Technical instructions and technical training
- (4) Product tests or inspections specified by you

The above content assumes transactions and usage within your region. Please consult with an IDEC sales representative regarding transactions and usage outside of your region. Also, IDEC provides no guarantees whatsoever regarding IDEC products sold outside your region.

IDEC CORPORATION

Head Office

6-64, Nishi-Miyahara-2-Chome, Yodogawa-ku, Osaka 532-0004, Japan

USA	IDEC Corporation	Tel: +1-408-747-0550	opencontact@idec.com
Germany	APEM GmbH	Tel: +49-40-25 30 54-0	service@eu.idec.com
Singapore	IDEC Izumi Asia Pte. Ltd.	Tel: +65-6746-1155	info@sg.idec.com
Thailand	IDEC Asia (Thailand) Co., Ltd	Tel: +66-2-392-9765	sales@th.idec.com
India	IDEC Controls India Private Limited	Tel: +91-80679-35328	info_india@idec.com
Taiwan	IDEC Taiwan Corporation	Tel: +886-2-2577-6938	service@tw.idec.com

Hong Kong	IDEC Izumi (H.K.) Co., Ltd.	Tel: +852-2803-8989	info@hk.idec.com
China	IDEC (Shanghai) Corporation	Tel: +86-21-6135-1515	idec@cn.idec.com
	Beijing Branch	Tel: +86-10-6581-6131	idec@cn.idec.com
	Guangzhou Branch	Tel: +86-20-8362-2394	idec@cn.idec.com
Japan	IDEC Corporation	Tel: +81-6-6398-2527	jp_marketing@idec.com

 www.idec.com

Specifications and other descriptions in this brochure are subject to change without notice.

