



Emergency Stop Switches
(Unibody/Illuminated)
XA/XW 16mm and 22mm Series



Short Body E-stop compliant with ISO13850

Emergency stop switches to ensure safety
and functionality



IDEC CORPORATION

COMPACT AND STANDARDS-COMPLIANT SAFETY DEVICES

Emergency stop (E-stop) switches are a fundamental safety element for all types of automation, but compact equipment sizes and increasing regulatory requirements are challenging designers to find better ways of incorporating E-stops.

The IDEC XA/XW short-body E-stops address this, featuring a minimal installation footprint and meeting the requirements of ISO13850:2015 by illuminating the cap in red when the E-stop is functional (Active) to be used in an emergency situation, and turning white when the E-stop is not-functional (Inactive).

With additional safety and durability features, designers now have more choices to ensure standards-compliant safety in industrial applications.



Active (Illuminated in red)

Inactive (Non-illuminated)

- XA series (illuminated switch)
Button color: white
Illuminated color: red

Features

Shortest depth in the IDEC X-Series lineup

Panel depth

- 12.6mm (solder terminal)
- 17.0mm (solder/tab #110 terminal)

Designed with the shortest body among multiple generations of IDEC emergency stop switches, this E-stop helps users save space behind the panel for their application.

Panel depth (solder terminal type)

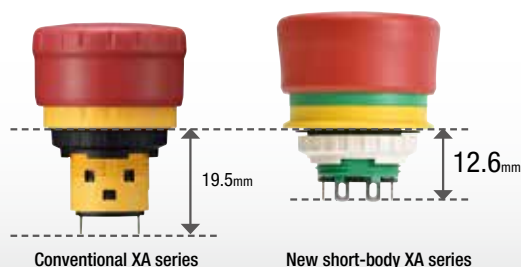

Unibody structure with 1NO-2NC contacts

Compact unibody structure with 3-terminal configuration suitable for a wide range of applications in limited space.

One contact (blue) can be used as a lamp terminal or as a NO contact for monitoring.

NO contact for monitoring or terminal for LED (marked in blue)

NC contact for main circuit (marked in red)

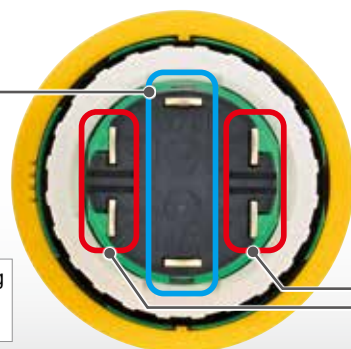

Status indicator and escape structure

The indicator (green area) visible from the side enables the user to check the operating status of the switch at a glance.

Also, an escape structure prevents foreign objects from being caught during operation, ensuring a smooth activation of the E-stop in an emergency situation.

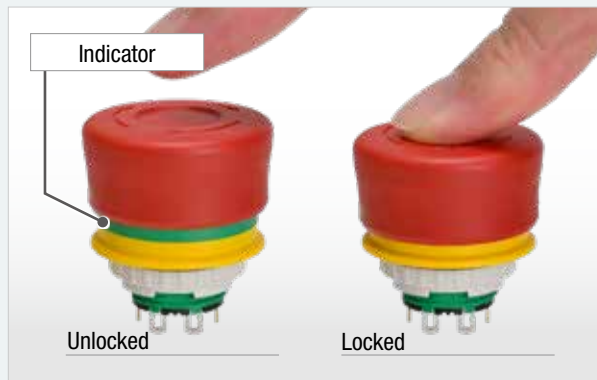
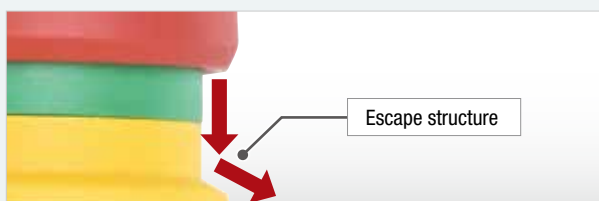

Certified for outdoor use

XA/XW series E-stops are UL type 4X certified, making them the ideal E-stops for use in wet, windy, and snowy environments.*

*Not certified for use in all outdoor environments.

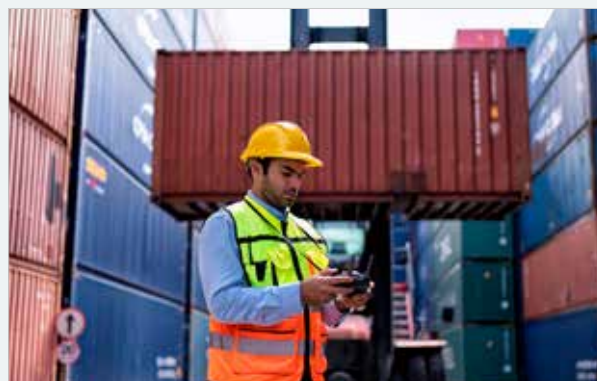

Safer E-stop with reverse energy structure

3rd generation (reverse energy structure)

The energy level of the new emergency stop switch

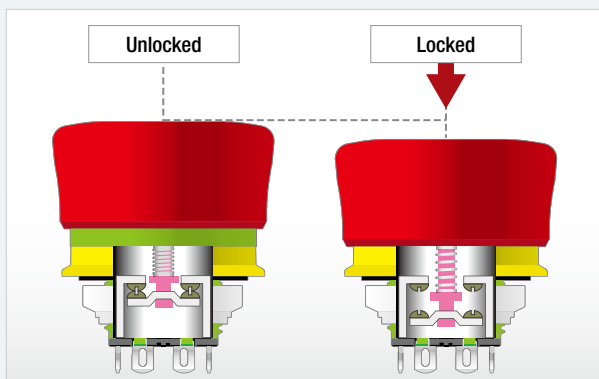

Main contacts (NC) are always inclined to turn off (safe)

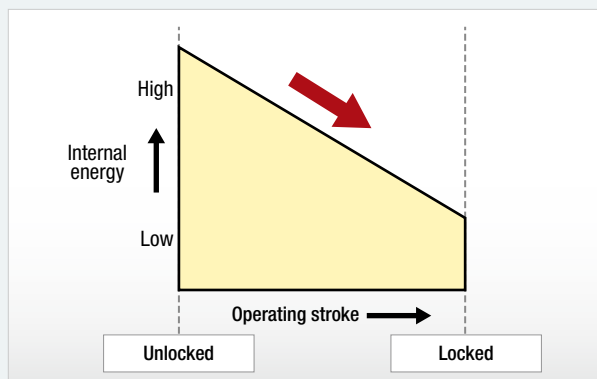

Emergency stop function on portable operator control stations

With the growing advancements in technology, users have been demanding more convenient and efficient options such as using detachable cables that allow a single teaching pendant to be used with multiple robots or eliminating the need for wiring altogether. However, safety remains a crucial aspect that must be considered with utmost care. Therefore, the requirements for detachable and wireless operator control stations have been updated in this revision to ensure maximum safety and reliability.

ISO13850: 2015

4.3.8.

When emergency stop devices are installed on detachable or cableless operator control stations (e.g. pluggable portable teaching pendants), at least one emergency stop device shall be permanently available (e.g. in a fixed position) on the machine.

In addition, at least one of the following measures shall be applied to avoid confusion between active and inactive emergency stop devices:

- device colour changing through illumination of the active emergency stop device;
- automatic (self-actuating) covering of inactive emergency stop devices; where this is not practicable, manually-applied covering may be used, provided that the cover remains attached to the operator control stations;
- provision of proper storage for detached or cableless operator control stations.

The instructions for use of the machine shall state, which measure has been applied in order to avoid confusion between active or inactive emergency stop device(s). The correct operation of this measure shall be explained.

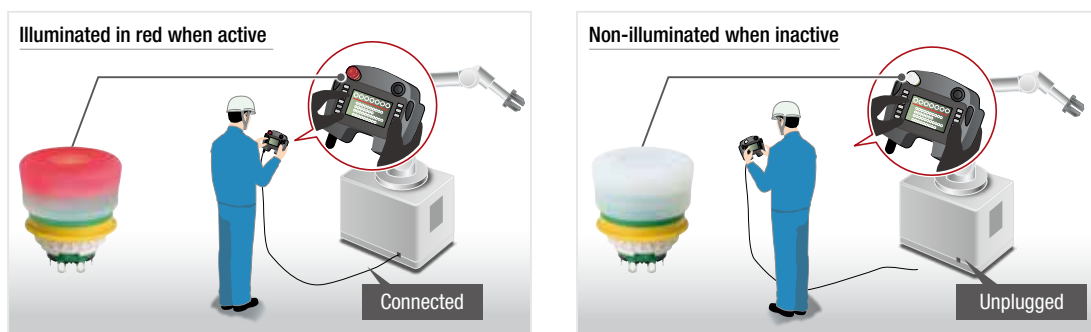

- Active/Inactive status does not indicate the button operation (lock/unlock) status of the emergency stop switch.

Intended actuation

Recommended actuators and nameplates

To ensure quick and effective response in case of an emergency, it is crucial to optimize the operability and visibility of the emergency stop switch. The switch should be easily accessible and actuated with intent and without any hesitation.

Therefore, the following safety requirements are included.

ISO13850:2015

4.1.1.2

The emergency stop function must be available and operable at all times.

4.3.6

The actuator of the emergency stop device shall be coloured **RED**. As far as a background exists behind the actuator and as far as it is practicable, the background shall be coloured **YELLOW**.

4.3.7

Neither the actuator nor the background should be **labelled with text or symbols**.

When it is necessary to identify the direction of unlatching of the actuator (button) then this identification shall have the same or nearly the **same colour as the actuator**.



Intended resetting

Importance of human intention in resetting

In emergency situations, an emergency stop switch requires an intentional action to be triggered. As such, it is also essential to consider the intended action required to reset the emergency stop switch as part of the safety requirements.

Resetting the switch

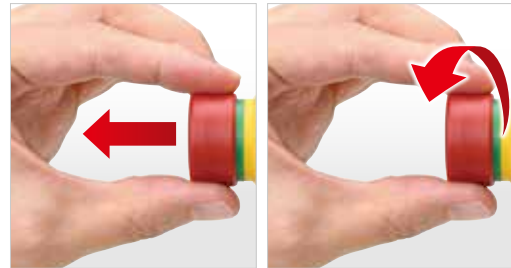

Pull to reset

Turn to reset

ISO13850:2015

4.1.1.2

The emergency stop function shall be reset by intentional human action. Resetting of the emergency stop function shall be operated by disengagement of an emergency stop device.

Example (IDEC XA series)

The NC contact does not move until the emergency stop switch latches (locks), allowing OFF operation and resetting only by the intended operation.

▶ The safety lock feature allows only the intended reset to operate.

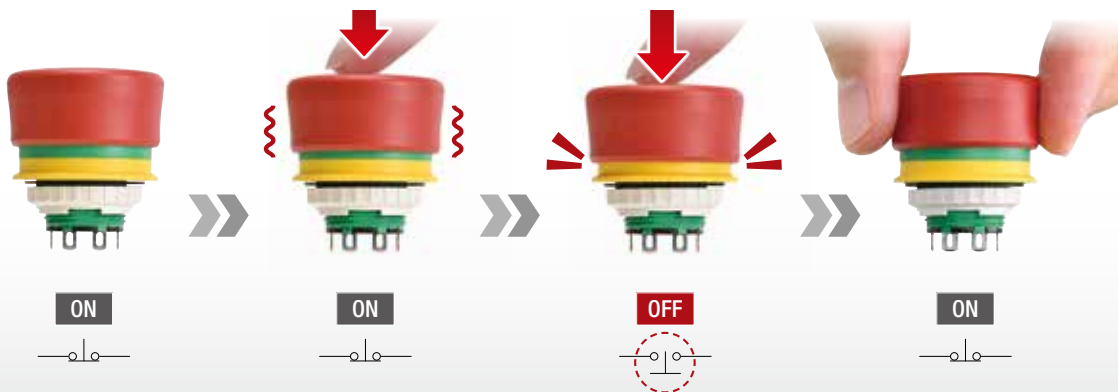

Emergency stop switches are vital safety components used across various industries to prevent accidents and ensure worker safety.

The new compact and short-body design XA/XW series offers a wider range of applications, making it a versatile and reliable solution for emergency stop needs.

Portable pendants and robot controllers



Low profile panels and small transport equipment



Outdoor facilities with high temperatures (Operating temperature up to +70°C)*



*Non-illuminated type only

Remote control box for use in environments exposed to rain

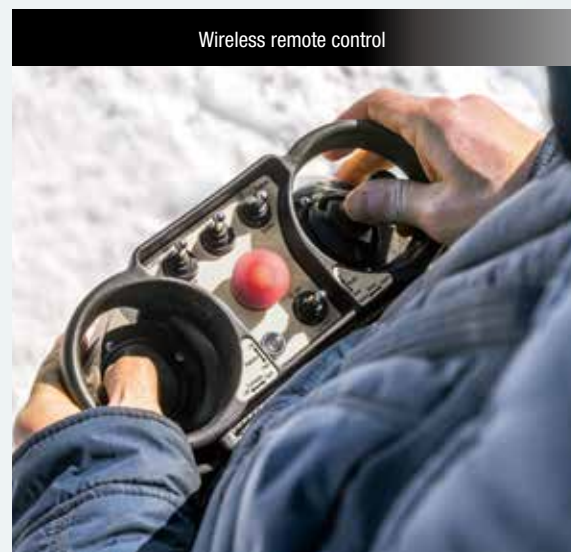

ø16 XA / ø22 XW Series

Emergency stop switches (unibody/illuminated)

The new addition to the XA/XW series features a reverse energy structure with illuminated or 1NO-2NC contact types available. These have a compact and unibody design with a panel depth of 12.6mm.

- Illuminated or 1NO-2NC contact types
- Two reset operations (Pushlock pull or turn reset)
- Reverse energy structure
- Safety lock mechanism (IEC60947-5-5: 6.2)
- Direct opening action mechanism (IEC60947-5-5: 5.2, IEC60947-5-1 annex K.)
- Protection degree IP65, IP67, (IEC60529) and IP69K (ISO20653)
- Indicator and escape structure



- See website for details on approvals and standards.

Contact ratings

Rated insulation voltage (Ui)		Non-illuminated	250V			
		Illuminated				
Rated current (Ith)		Non-illuminated	5A			
		Illuminated	3A			
Rated operating voltage (Ue)			30V	125V	250V	
Rated operating current (*1)	Main contact	AC 50/60Hz	Resistive load (AC-12)	–	3A	1.5A
			Inductive load (AC-15)	–	1.5A	1.5A
		DC	Resistive load (DC-12)	2A	0.4A	0.2A
			Inductive load (DC-13)	1A	0.22A	0.1A
	Monitor contact	AC 50/60Hz	Resistive load (AC-12)	–	1.2A	0.6A
			Inductive load (AC-15)	–	0.6A	0.3A
		DC	Resistive load (DC-12)	2A	0.4A	0.2A
			Inductive load (DC-13)	1A	0.22A	0.1A
Contact material		Gold on silver, crossbar contacts				

- Minimum applicable load (reference value) = 5V AC/DC, 1mA (Applicable range may vary with operating conditions and load types.)
- Operational current represents the classification by making and breaking current (IEC 60947-5-1)

*1) UL recognized ratings: Pilot Duty AC 1.5A / 250V
Pilot Duty DC 1A/30V
Maximum ambient air temperature 60°C
TÜV / CCC certified ratings: AC-15 1.5A / 250V, DC-13 1A / 30V

Performance Specifications

Type	XA	XW
Applicable standards	IEC 60947-1, EN 60947-1, JIS C 8201-1 IEC 60947-5-1, EN 60947-5-1, JIS C 8201-5-1, IEC60947-5-5 (*2), EN60947-5-5 (*2), JIS C 8201-5-5 (*2) UL60947-5-5 (*2) , UL991 (*2), NFPA79 (*2), ISO13850 (*3), UL508, CSA C 22.2 No. 14, GB/T14048.5	
Standard operating conditions	Operating temperature	Non-illuminated: -25 to +70°C (no freezing) Illuminated: -25 to +55°C (no freezing)
	Operating humidity	30 to 85%RH (no condensation)
	Storage temperature	Non-illuminated: -45 to +80°C (no freezing) Illuminated: -30 to +70°C (no freezing)
Operating force	Pushlock: 20N Pull reset: 12N Turn reset: 0.2N·m	
Minimum force required for direct opening action	50N	
Minimum operator stroke required for direct opening action	3mm	
Maximum operator stroke	4.1mm	
Contact resistance	50mΩ max. (initial value)	
Insulation resistance	100MΩ min. (500V DC megger)	
Overtoltage category	II	
Impulse withstand voltage	2.5kV	
Degree of pollution	Panel front:3, Panel back: 2	

*2) Yellow/Gray button types are not subject to relevant standards and cannot be used as an emergency stop switch.

*3) Illuminated white button should be used with red illumination in accordance with ISO13850.



Illumination rating

Rated voltage	Coil voltage range	Rated current
24V AC/DC	24V AC/DC ±10%	Typ.10mA

Type	XA	XW
Operation frequency	900 operations per hour	
LED life	60,000 hours (Ta = 25°C, 45%RH) (The total illumination life in which the illuminance maintains a minimum of 50% of the initial value.)	
Shock resistance	Operating extremes: 150m/s ² Damage limits: 1000m/s ²	
Vibration resistance	Operating extremes: 10 to 500Hz, amplitude 0.35mm, acceleration 50 m/s ² Damage limits: 10 to 500Hz, amplitude 0.35mm, acceleration 50m/s ²	
Durability	Mechanical: 250,000 times min. Electrical: 100,000 times min. 250,000 times min. (24V AC/DC, 100mA)	
Degree of Protection (*4)	Panel front: IP65, IP67, IP69K, UL Type 4X	
Impact protection	Equivalent to IK06, 07 *No damages	
Short-circuit protection	250V/10A fuse (Type aM IEC60269-1/IEC60269-2)	
Conditional short-circuit current	100A	
Terminal style	Solder terminal Solder/tab #110 terminal	
Recommended tightening torque of locking ring	0.8 to 0.9N·m	1.8 to 2N·m
Connectable wire	1.25mm ² max. (AWG16 max.)	
Terminal soldering conditions	310 to 350°C, within 3 seconds	
Weight (approx.)	Approx. 15g	Approx. 17g

*4) The protective structure is based on the test conditions of IEC60529, ISO20653, and JIS C 0920. This is not guaranteed for all operating environments. The specification values for the protective structure are for products that have been installed.

Emergency Stop Switches

ø16 XA pushlock pull or turn reset switch (non-illuminated)

Quantity: 1

Shape	Part No.	Contact	Terminal style	Button color
	XA1E-BV3SG01*	1NC	Solder terminal	Red Bright red
	XA1E-BV3SG01T*		Solder/tab #110 terminal	
	XA1E-BV3SG02*	2NC	Solder terminal	
	XA1E-BV3SG02T*		Solder/tab #110 terminal	
	XA1E-BV3SG12*	1NO-2NC	Solder terminal	
	XA1E-BV3SG12T*		Solder/tab #110 terminal	

- *Color code: R (red), RH (bright red)
- Push lock pull or turn reset switches are locked when pressed, and reset when pulled or turned clockwise.

ø22 XW pushlock pull or turn reset switch (non-illuminated)



Quantity: 1

Shape	Part No.	Contact	Terminal style	Button color
	XW1E-BV3SG01*	1NC	Solder terminal	Red Bright red
	XW1E-BV3SG01T*		Solder/tab #110 terminal	
	XW1E-BV3SG02*	2NC	Solder terminal	
	XW1E-BV3SG02T*		Solder/tab #110 terminal	
	XW1E-BV3SG12*	1NO-2NC	Solder terminal	
	XW1E-BV3SG12T*		Solder/tab #110 terminal	

- *Color code: R (red), RH (bright red)
- Pushlock pull or turn reset switches are locked when pressed, and reset when pulled or turned clockwise.



ø16 XA pushlock pull or turn reset switch (illuminated)

Quantity: 1

Shape	Part No.	Contact	Terminal style	Button color	Illuminated color
	XA1E-LV3SG02Q4R	2NC	Solder terminal	Red	Red
	XA1E-LV3SG02Q4TR		Solder/tab #110 terminal		
	XA1E-LV3SG02Q4WR	2NC	Solder terminal	White	Red
	XA1E-LV3SG02Q4TWR		Solder/tab #110 terminal		





ø22 XW pushlock pull or turn reset switch (illuminated)

Quantity: 1

Shape	Part No.	Contact	Terminal style	Button color	Illuminated color
	XW1E-LV3SG02Q4R	2NC	Solder terminal	Red	Red
	XW1E-LV3SG02Q4TR		Solder/tab #110 terminal		
	XW1E-LV3SG02Q4WR	2NC	Solder terminal	White	Red
	XW1E-LV3SG02Q4TWR		Solder/tab #110 terminal		

- When using white button color, make sure to use the switch as an active state when illuminated.
- Pushlock pull or turn reset switches are locked when pressed, and reset when pulled or turned clockwise.

Accessories

Name / Shape	Part No.	Specification	Ordering No.	Quantity	Remarks
Locking ring wrench 	MT-001	Metal (brass, nickel plated)	MT-001	1	For XA series. Used to tighten the locking ring when mounting the unit to the panel.
Locking ring 	XA9Z-LNW	Polyamide resin (White)	XA9Z-LNW	1 (10 pcs)	For XA series
Locking ring wrench 	MW9Z-T1	Metal (Brass)	MW9Z-T1	1	For XW series. Used to tighten the locking ring when mounting the unit to the panel.
Locking ring 	XW9Z-LNW	Polyamide resin (White)	XW9Z-LNWPN	1 (5 pcs)	For XW series

All dimensions in mm.

Dimensions

ø16 XA pushlock pull or turn reset switch (illuminated or non-illuminated)

Solder terminal

Solder/tab #110 terminal

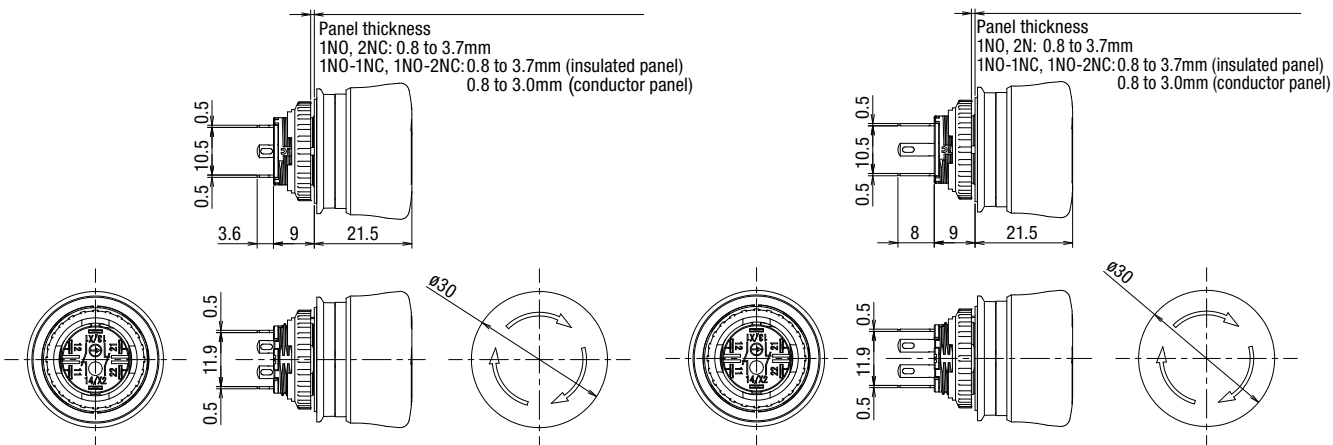

ø22 XW pushlock pull or turn reset switch (illuminated or non-illuminated)

Solder terminal

Solder/tab #110 terminal

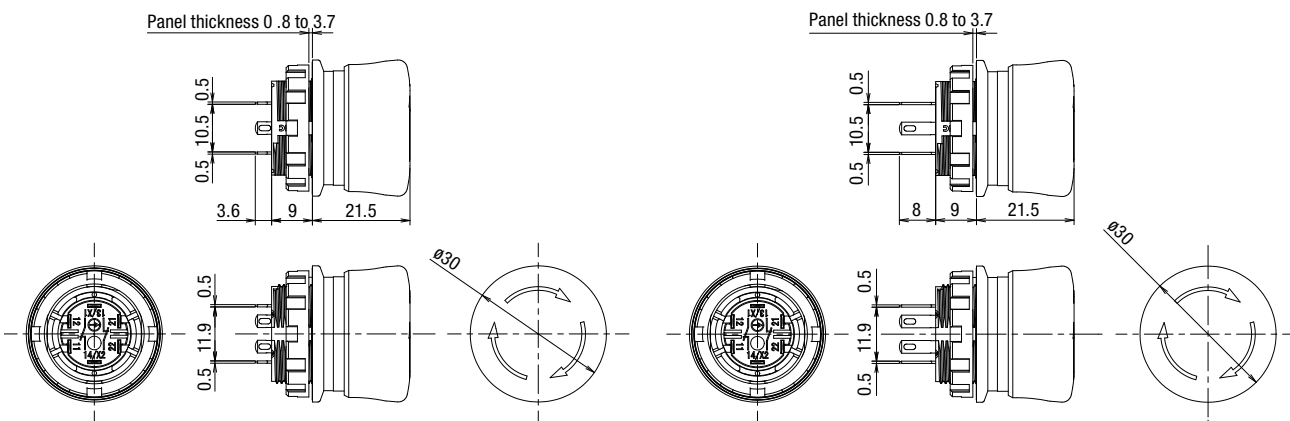

Panel cut-out

ø16 XA pushlock pull or turn reset switch (illuminated or non-illuminated)

ø22 XW pushlock pull or turn reset switch (illuminated or non-illuminated)

All dimensions in mm.



Terminal arrangement (BOTTOM VIEW)

Non-illuminated

Illuminated

1NC contact

2NC contact

1NO-1NC contact

1NO-2NC contact

1NC contact

2NC contact

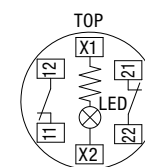
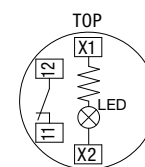
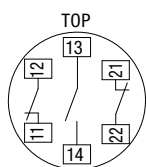
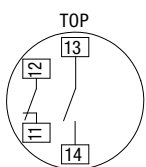
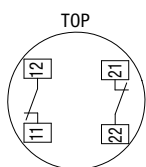
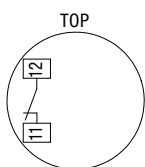

1NC: Terminals on left
2NC: Terminals on right

1NC: Terminals on left
2NC: Terminals on right

1NC: Terminals on left
2NC: Terminals on right

Safety Precautions

- Turn off the power to the product before starting installation, removal, wiring, maintenance, and inspection of the products. Failure to turn power off may cause electrical shock or fire.
- Use wires of the proper size to meet the voltage and current requirements. Incorrect wiring causes overheating, resulting in a possible fire hazard. Provide appropriate protection against electric shock. Failure to turn power off may cause electrical shock or fire.

Instructions

Panel mounting

Notes for panel mounting

Do not tighten with excessive force using tools such as pliers. Otherwise the locking ring may be damaged.

XA series

Remove the locking ring from the operator and check that the rubber gasket is in place. Insert the operator from panel front into the panel hole. Install the locking ring with the recommended tightening torque by aligning the protrusion A of the operator with the panel hole groove. Using the locking ring wrench MT-001, tighten the locking ring to a torque of 0.8 to 0.9N·m.

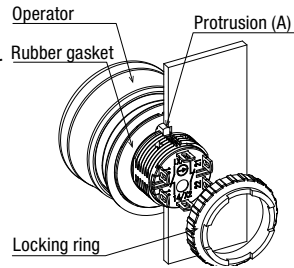

X Series

Remove the locking ring from the operator and insert the operator from panel front into the panel hole. Install the locking ring with the recommended tightening torque by aligning the protrusion B of the operator with the panel hole groove. Using the locking ring wrench MW9Z-T1, tighten the locking ring to a torque of 1.8 to 2.0N·m.

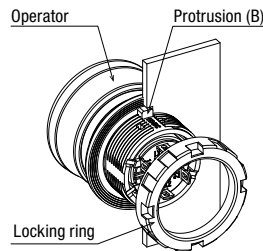

Wiring (Notes for solder terminal)

- 1) The applicable wire size is 1.25mm² maximum. The wires should be soldered through the holes in the terminals.
- 2) Solder the terminals using a soldering iron at 310 to 350°C for within 3 seconds. Do not use flow or dip soldering. (Sn-Ag-Cu type lead-free solder is recommended.) When soldering, make sure to solder as far away as possible from the plastic part of the switch body. Do not apply external force such as bending the terminals or pulling the wires. Check the operation using the actual load.
- 3) Use a non-corrosive rosin-based flux. To prevent the flux from entering the switch while soldering, face the terminals downward.

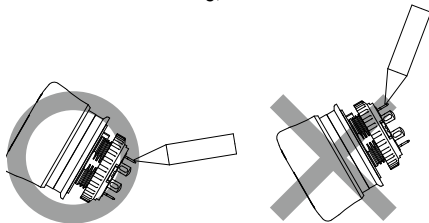

- 4) Because the terminal spacing is narrow, use protective tubes or heat shrinkable tubes to avoid burning the wire sheath or short circuit.
- 5) Apply force on the terminals in the vertical direction to the panel only, otherwise the terminals will be damaged.

Wiring (solder/tab #110 terminal)

- 1) Use quick connect #110 and 0.5mm tab thickness.
- 2) To prevent short-circuit between different poles, use protective tubes or heat shrink tubes.
- 3) Apply force on the terminals in the vertical direction to the panel only, otherwise the terminals will be damaged.

Contact chatter/bounce

Contact chatter/bounce may occur when the main contact (NC contact) is reset by pulling or turning or when the monitor contact (NO contact) is pressed. Take countermeasures to prevent chatter/bounce. (Reference value: 20ms)

Also, do not apply external shock to the switch as chatter may occur.

LED Illuminated Switches

- Illumination colors and illuminance may vary depending on the LED element and each product.
- An LED lamp is built into the contact block and cannot be replaced.

Notes

- Do not expose the switch to excessive shock and vibration, otherwise the switch may be deformed or damaged, causing malfunction or operation failure.
- Be sure to observe the operating ambient temperature. Ambient operating temperature is the temperature surrounding the product. Check the ambient temperature when using the product. Conditions exceeding the specifications may cause the internal temperature to rise, resulting in failure.
- Do not disassemble, repair, or modify the power supplies.
- The color of the button may vary on the production lot.
- The resin may discolor if left in a high temperature environment.
- Do not install in the following environment
 - (1) Where this product is exposed to high-pressure water. (Exceeding specifications equivalent to IEC60529 protection classes IPX5, IPX7, and IPX9K)
 - (2) Where dust (locations exceeding the specifications equivalent to IEC60529 protection class IP6X)
 - (3) Where safety and reliability may be impaired by corrosive, volatile, flammable or chemicals gases, etc.
 - (4) Where strong magnetic fields or strong electric fields are generated.
 - (5) Where flammable substances are generated or exist.
 - (6) Locations where condensation or icing may occur, such as inside freezers, air conditioner vents, etc. (When using the product in the above locations, take measures to prevent condensation or icing.)
 - (9) Where ozone, radiation, or ultraviolet rays may impair safety or reliability.

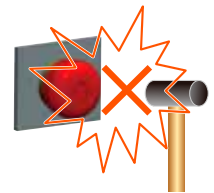

Be sure to read the instruction manual carefully before performing installation, wiring, or maintenance work.

For details on mounting, wiring, and maintenance, see the instruction manual from the URL below.

URL: <https://product.idec.com/?product=XA1E-XW1E>



Ordering Terms and Conditions

Thank you for using IDEC Products.

By purchasing products listed in our catalogs, datasheets, and the like (hereinafter referred to as "Catalogs") you agree to be bound by these terms and conditions. Please read and agree to the terms and conditions before placing your order.

1. Notes on contents of Catalogs

- (1) Rated values, performance values, and specification values of IDEC products listed in this Catalog are values acquired under respective conditions in independent testing, and do not guarantee values gained in combined conditions.
Also, durability varies depending on the usage environment and usage conditions.
- (2) Reference data and reference values listed in Catalogs are for reference purposes only, and do not guarantee that the product will always operate appropriately in that range.
- (3) The specifications / appearance and accessories of IDEC products listed in Catalogs are subject to change or termination of sales without notice, for improvement or other reasons.
- (4) The content of Catalogs is subject to change without notice.

2. Note on applications

- (1) If using IDEC products in combination with other products, confirm the applicable laws / regulations and standards.
Also, confirm that IDEC products are compatible with your systems, machines, devices, and the like by using under the actual conditions. IDEC shall bear no liability whatsoever regarding the compatibility with IDEC products.
- (2) The usage examples and application examples listed in Catalogs are for reference purposes only. Therefore, when introducing a product, confirm the performance and safety of the instruments, devices, and the like before use. Furthermore, regarding these examples, IDEC does not grant license to use IDEC products to you, and IDEC offers no warranties regarding the ownership of intellectual property rights or non-infringement upon the intellectual property rights of third parties.
- (3) When using IDEC products, be cautious when implementing the following.
 - i. Use of IDEC products with sufficient allowance for rating and performance
 - ii. Safety design, including redundant design and malfunction prevention design that prevents other danger and damage even in the event that an IDEC product fails
 - iii. Wiring and installation that ensures the IDEC product used in your system, machine, device, or the like can perform and function according to its specifications
- (4) Continuing to use an IDEC product even after the performance has deteriorated can result in abnormal heat, smoke, fires, and the like due to insulation deterioration or the like. Perform periodic maintenance for IDEC products and the systems, machines, devices, and the like in which they are used.
- (5) IDEC products are developed and manufactured as general-purpose products for general industrial products. They are not intended for use in the following applications, and in the event that you use an IDEC product for these applications, unless otherwise agreed upon between you and IDEC, IDEC shall provide no guarantees whatsoever regarding IDEC products.
 - i. Use in applications that require a high degree of safety, including nuclear power control equipment, transportation equipment (railroads / airplanes / ships / vehicles / vehicle instruments, etc.), equipment for use in outer space, elevating equipment, medical instruments, safety devices, or any other equipment, instruments, or the like that could endanger life or human health
 - ii. Use in applications that require a high degree of reliability, such as provision systems for gas / waterworks / electricity, etc., systems that operate continuously for 24 hours, and settlement systems
 - iii. Use in applications where the product may be handled or used deviating from the specifications or conditions / environment listed in the Catalogs, such as equipment used outdoors or applications in environments subject to chemical pollution or electromagnetic interference
If you would like to use IDEC products in the above applications, be sure to consult with an IDEC sales representative.

3. Inspections

We ask that you implement inspections for IDEC products you purchase without delay, as well as thoroughly keep in mind management/maintenance regarding handling of the product before and during the inspection.

4. Warranty

(1) Warranty period

The warranty period for IDEC products shall be one (1) year after purchase or delivery to the specified location. However, this shall not apply in cases where there is a different specification in the Catalogs or there is another agreement in place between you and IDEC.

(2) Warranty scope

Should a failure occur in an IDEC product during the above warranty period for reasons attributable to IDEC, then IDEC shall replace or repair that product, free of charge, at the purchase location / delivery location of the product, or an IDEC service base. However, failures caused by the following reasons shall be deemed outside the scope of this warranty.

- i. The product was handled or used deviating from the conditions / environment listed in the Catalogs
 - ii. The failure was caused by reasons other than an IDEC product
 - iii. Modification or repair was performed by a party other than IDEC
 - iv. The failure was caused by a software program of a party other than IDEC
 - v. The product was used outside of its original purpose
 - vi. Replacement of maintenance parts, installation of accessories, or the like was not performed properly in accordance with the user's manual and Catalogs
 - vii. The failure could not have been predicted with the scientific and technical standards at the time when the product was shipped from IDEC
 - viii. The failure was due to other causes not attributable to IDEC (including cases of force majeure such as natural disasters and other disasters)
- Furthermore, the warranty described here refers to a warranty on the IDEC product as a unit, and damages induced by the failure of an IDEC product are excluded from this warranty.

5. Limitation of liability

The warranty listed in this Agreement is the full and complete warranty for IDEC products, and IDEC shall bear no liability whatsoever regarding special damages, indirect damages, incidental damages, or passive damages that occurred due to an IDEC product.

6. Service scope

The prices of IDEC products do not include the cost of services, such as dispatching technicians. Therefore, separate fees are required in the following cases.

- (1) Instructions for installation / adjustment and accompaniment at test operation (including creating application software and testing operation, etc.)
- (2) Maintenance inspections, adjustments, and repairs
- (3) Technical instructions and technical training
- (4) Product tests or inspections specified by you

The above content assumes transactions and usage within your region. Please consult with an IDEC sales representative regarding transactions and usage outside of your region. Also, IDEC provides no guarantees whatsoever regarding IDEC products sold outside your region.

IDEC CORPORATION

Head Office 6-64, Nishi-Miyahara-2-Chome, Yodogawa-ku, Osaka 532-0004, Japan

USA IDEC Corporation
EMEA APEM SAS

Singapore IDEC Izumi Asia Pte. Ltd.
Thailand IDEC Asia (Thailand) Co., Ltd.
India IDEC Controls India Private Ltd.

China IDEC (Shanghai) Corporation
IDEC Izumi (H.K.) Co., Ltd.
Taiwan IDEC Taiwan Corporation

Japan IDEC Corporation

 www.idec.com