



Slim Power Relays/Relay Sockets
RJ Series Plug-in Relays/SJ Series Sockets



Compact slim power relays with high capacity

Relay sockets available with slim space-saving
push-in terminals and standard screw terminals.

IDEC CORPORATION

Slim power relays

RJ Series

Compact slim power relays with high capacity

RJ series slim power relays are plug-in terminal relays suitable for various applications such as control panels and machine tools.



Lloyd's Register and DNV certified.
See website for details on approvals and standards.

High capacity

Highly conductive materials ensure stable current-carrying performance even under high currents.

Maximum allowable contact current

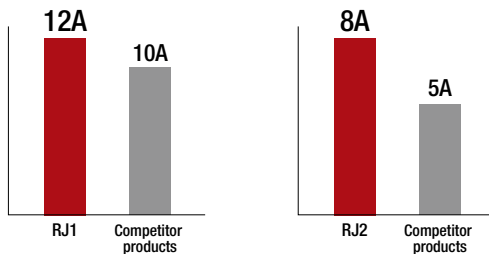

Note) Comparison with equivalent competitor products (based on IDEC research, March 2023)

Wide range of variations

Bifurcated contact relays for high reliability

Applicable for loads as low as 1V DC, 100 μ A (reference value).

A wide range of auxiliary features such as RC circuits and diodes available.

Protects electronic components in the circuit by absorbing back EMF (surge) generated by relay coils.

Excellent durability

Unique return spring structure improves durability and reliability of mechanical parts.

Mechanical durability

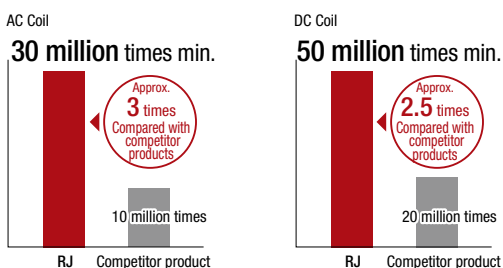

Note) Comparison with equivalent competitor products (based on IDEC research, March 2023)

User-friendly product design

Highly visible operation indicator LED

IDEC's unique light guide structure allows the status to be checked at a glance from the top surface of the relay housing.

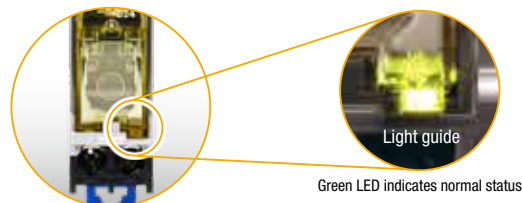

Voltage can be identified by tape color

The color of the tape is different for each rated coil voltage, so the rated voltage can be easily recognized. (*1)



*1) The voltage is marked on the yellow tape.

Relay sockets SJ Series

Low-profile, space-saving sockets for RJ series relays

Push-in terminal, standard screw terminal, and finger-safe screw terminal types can be selected depending on the application.



(Push-in terminal, standard screw terminal relay sockets)
See website for details on approvals and standards.



(Finger-safe screw terminal relay sockets)

Time saving & efficient

Push-in terminal

Save up to 55% in wiring time

Wiring time reduced greatly compared with conventional screw terminals. (compared with IDEC products)

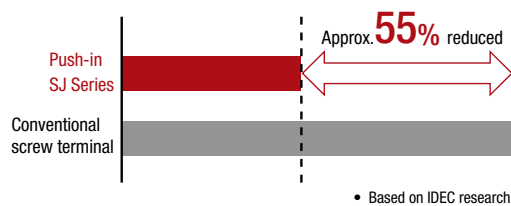

Reduce maintenance work

Push-in terminals eliminate the need for torque maintenance such as tightening of screws, because screws are not used.

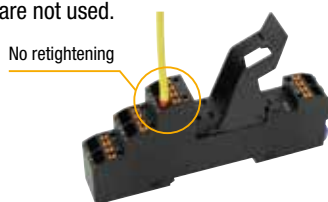

High visibility

Push-in terminal

Proven reliability

The terminal number on the socket can be clearly seen on the socket preventing incorrect wiring. Also, the safe structure of the pusher prevents the driver from directly contacting the spring.

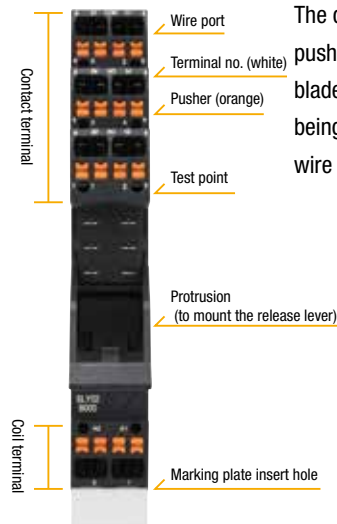

The distinct color of the pusher prevents the flat blade screwdriver from being inserted into the wire port.

Equipped with a release lever

Easy to remove in tight spaces

Easy to remove with fingers, even in tight spaces when mounted on a DIN rail.



RJ Series Slim Power Relays

Compact and durable slim power relay with high allowable contact current.

• RJ Series For PCB terminal types, see website.
https://apac.idec.com/c/RJ_PCB_Series



RJ Series

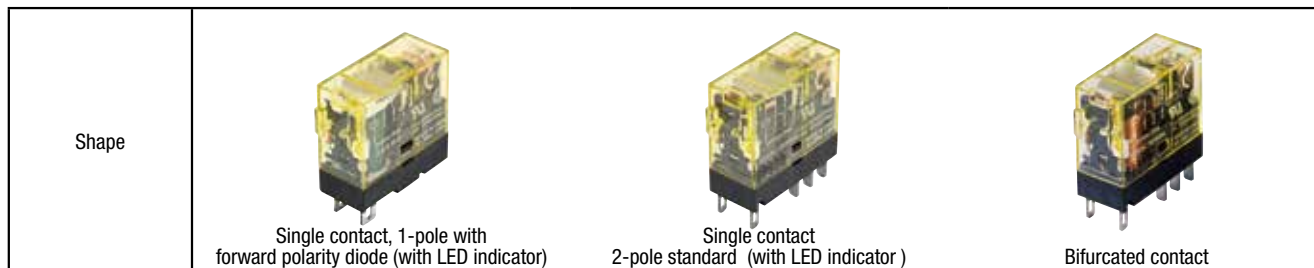

Single contact

Package quantity: 1

Type	1-pole (SPDT)		2-pole (DPDT)	
	Part No. (Ordering No.)	Code: □	Part No. (Ordering No.)	Code: □
Standard (with LED indicator)	RJ1S-CL-□	A12, A24, A100, A110	RJ2S-CL-□	A12, A24, A100, A110
		A200, A220		A200, A220
		D5, D6, D12, D24, D48		D5, D6, D12, D24, D48
Simple (*1)	RJ1S-C-□	A12, A24, A100, A110	RJ2S-C-□	A12, A24, A100, A110
		A200, A220		A200, A220
		D5, D6, D12, D24, D48		D5, D6, D12, D24, D48
With forward polarity diode (with LED indicator)	RJ1S-CLD-□	D5, D6, D12, D24, D48	RJ2S-CLD-□	D5, D6, D12, D24, D48
		D100		D100
With forward polarity diode (*1)	RJ1S-CD-□	D5, D6, D12, D24, D48	RJ2S-CD-□	D5, D6, D12, D24, D48
		D100		D100
With reverse polarity diode (with LED indicator)	RJ1S-CLD1-□	D5, D6, D12, D24, D48	RJ2S-CLD1-□	D5, D6, D12, D24, D48
		D100		D100
With reverse polarity diode (*1)	RJ1S-CD1-□	D5, D6, D12, D24, D48	RJ2S-CD1-□	D5, D6, D12, D24, D48
		D100		D100
With RC circuit (with LED indicator)	RJ1S-CLR-□	A12, A24, A100, A110	RJ2S-CLR-□	A12, A24, A100, A110
		A200, A220		A200, A220
With RC circuit (*1)	RJ1S-CR-□	A12, A24, A100, A110	RJ2S-CR-□	A12, A24, A100, A110
		A200, A220		A200, A220

Coil rated voltage

Code	Coil voltage
A12	12V AC
A24	24V AC
A100	100-(110) V AC
A110	110V AC
A115	115V AC
A120	120V AC
A200	200-(220)V AC
A220	220V AC
A230	230V AC
A240	240V AC
D5	5V DC
D6	6V DC
D12	12V DC
D24	24V DC
D48	48V DC
D100	100-110V DC

*1) Not equipped with LED indicators.

• Other coil voltages available. (A115, A120, A230, A240)

A100 and A200 are 3-rated coils.

(Refer to coil rating table)

Bifurcated contact (PCB terminal)

Package quantity: 1

Type	2-pole (DPDT bifurcated contact)	
	Part No. (Ordering No.)	Code: □
Standard (with LED indicator)	RJ22S-CL-□	A12, A24, A100, A110, A115, A120, A200, A220, A230, A240
		D5, D6, D12, D24, D48, D100
Simple (*2)	RJ22S-C-□	A12, A24, A100, A110, A115, A120, A200, A220, A230, A240
		D5, D6, D12, D24, D48, D100
With forward polarity diode (with LED indicator)	RJ22S-CLD-□	D5, D6, D12, D24, D48, D100
With forward polarity diode (*2)	RJ22S-CD-□	D5, D6, D12, D24, D48, D100
With reverse polarity diode (with LED indicator)	RJ22S-CLD1-□	D5, D6, D12, D24, D48, D100
With reverse polarity diode (*2)	RJ22S-CD1-□	D5, D6, D12, D24, D48, D100
With RC circuit (with LED indicator)	RJ22S-CLR-□	A12, A24, A100, A110, A115, A120, A200, A220, A230, A240
With RC circuit (*2)	RJ22S-CR-□	A12, A24, A100, A110, A115, A120, A200, A220, A230, A240

*2) Not equipped with LED indicators.

Contact ratings

Single contact

No. of poles	Contact	Allowable contact power		Rated load			Allowable switching current	Allowable switching voltage	Minimum applicable load (*1)
		Resistive load	Inductive load	Voltage	Resistive load	Inductive load cosφ=0.4 L/R=7ms			
1-pole	NO contact side	3000VA AC	1875VA AC	250V AC	12A	7.5A	12A	250V AC 125V DC	5V DC 100mA (Reference value)
		360W DC	180W DC	30V DC	12A	6A			
	NC contact side	3000VA AC	1875VA AC	250V AC	12A	7.5A			
		180W DC	90W DC	30V DC	6A	3A			
2-pole	NO contact side	2000VA AC	1000VA AC	250V AC	8A	4A	8A	250V AC 125V DC	5V DC 10mA (Reference value)
		240W DC	120W DC	30V DC	8A	4A			
	NC contact side	2000VA AC	1000VA DC	250V AC	8A	4A			
		120W DC	60W DC	30V DC	4A	2A			

*1) Measured at operating frequency of 120 operations/min. Failure rate P level (reference value)

Bifurcated contact

Allowable contact power		Rated load			Allowable switching current	Allowable switching voltage	Minimum applicable load (*2)
Resistive load	Inductive load	Voltage	Resistive load	Inductive load cosφ=0.4 L/R=7ms			
250VA AC 30W DC	100VA AC 15W DC	250V AC	1A	0.4A	1A	250V AC 125V DC	1V DC 100μA (reference value)
		30V DC	1A	0.5A			

*2) Measured at operating frequency of 120 operations/min. Failure rate P level (reference value)

Approval ratings

Single contact

Voltage	UL ratings				CSA ratings								VDE ratings			
	Resistive				Resistive				Inductive				Resistive		AC-15, DC-13 (*3)	
	RJ1		RJ2		RJ1		RJ2		RJ1		RJ2		RJ1	RJ2	RJ1	RJ2
	NO	NC	NO	NC	NO	NC	NO	NC	NO	NC	NO	NC	NO	NO	NO	NO
250V AC	12A	6A	8A	4A	12A	12A	8A	8A	7.5A	7.5A	4A	4A	12A	8A	6A	3A
30V DC	12A	6A	8A	4A	12A	6A	8A	4A	6A	3A	4A	2A	12A	8A	2.5A	2A

Note: According to the utilization categories of IEC 60947-5-1.

Bifurcated contact

Voltage	UL ratings				CSA ratings				VDE ratings			
	Resistive		General Use		Resistive		Inductive		General Use		Resistive	
	NO	NC	NO	NC	NO	NC	NO	NC	NO	NC	NO	NC
250V AC	-	-	1A	1A	-	-	-	-	1A	1A	1A	1A
30V DC	1A	1A	-	-	1A	1A	1A	1A	-	-	1A	1A

Note: According to the utilization categories of IEC60947-5-1.

Coil rating

Coil rated voltage (V)	Code □	Without LED indicator				With LED indicator				Operating characteristics (against rated values at 20°C)			Power consumption
		Rated current (mA) ±15% (at 20°C)		Coil resistance (Ω)±10% (at 20°C)	Rated current (mA) ±15% (at 20°C)		Coil resistance (Ω)±10% (at 20°C)	Minimum operating voltage (initial value)	Return voltage (initial value)	Maximum allowable voltage (*5)			
		50Hz	60Hz		50Hz	60Hz							
AC 50/60Hz (*4)	12V	A12	87.3	75.0	62.5	91.1	78.8	62.5	80% max.	30% min.	140%	Approx. 1.1VA (50Hz) Approx. 0.9 to 1.2VA (60Hz)	
	24V	A24	43.9	37.5	243	47.5	41.1	243					
	100-(110)V	A100	10.5	9.0-10.4	4470	10.3	8.8-10.2	4470					
	110V	A110	9.6	8.2	5270	9.5	8.1	5270					
	115V	A115	9.1	7.8	6030	9.0	7.7	6030					
	120V	A120	8.8	7.5	6400	8.7	7.4	6400					
	200-(220)V	A200	5.3	4.5×5.2	17,950	5.3	4.5×5.2	17,950					
	220V	A220	4.8	4.1	21,530	4.8	4.1	21530					
	230V	A230	4.6	3.9	24,100	4.6	3.9	24,100					
240V	A240	4.3	3.7	25,570	4.3	3.7	25,570						
DC	5V	D5	106	47.2	110	47.2	70% max.	10% min.	170%	Approx. 0.53 to 0.64W			
	6V	D6	88.3	67.9	92.2	67.9							
	12V	D12	44.2	271	48.0	271							
	24V	D24	22.1	1080	25.7	1080							
	48V	D48	11.0	4340	10.7	4340							
	100-110V	D100	5.3-5.8	18,870	5.2-5.7	18,870							

*4)100-(110)V and 200-(220)V are 3 rated coils.
100-(110)V: 100V AC (50/60Hz), 110V AC (60Hz)
200-(220)V: 200V AC (50/60Hz), 220V AC (60Hz)

*5) The maximum allowable voltage is the maximum value of voltage that can be applied to the relay coil and not the continuous allowable value.

Characteristics

Part No.	RJ1S	RJ2S	RJ22S
No. of Poles	1-pole	2-pole	2-pole
Contact configuration	SPDT contact	DPDT contact	DPDT (bifurcated contacts)
Contact material	AgNi		AgNi (Au clad)
Degree of Protection	IP40 (enclosed)		
Contact resistance (initial value) (*1)	50mΩ max.		
Operating time (*2)	15ms max.		
Release time (*2)	10ms max.		
Insulation resistance	100MΩ min. (500V DC megger)		
Dielectric strength	Between contact circuit and coil	5000V AC, 1 minute	5000V AC, 1 minute
	Between contacts of the same pole	1000V AC, 1 minute	1000V AC, 1 minute
	Between contacts of different poles	-	3000V AC, 1 minute
Vibration resistance	Operating extremes	Damage limits: 10 to 55Hz, amplitude 0.75mm	
	Damage limits	Damage limits: 10 to 55Hz, amplitude 0.75mm	
Shock resistance	Operating extremes	NO contact side: 200 m/s ² , NC contact side: 100 m/s ²	
	Damage limits	1000m/s ²	
Electrical life (rated load)	AC load: 200,000 times min. (operating frequency: 1800 operations per hour) DC load: 100,000 times min. (operating frequency: 1800 operations per hour)		AC load: 100,000 times min. (operating frequency: 1800 operations per hour) DC load: 200,000 times min. (operating frequency: 1800 operations per hour)
Mechanical life (no load)	AC coil: 30 million times min. (operating frequency: 18,000 operations per hour) DC coil: 50 million times min. (operating frequency: 18,000 operations per hour)		AC coil: 10 million times min. (operating frequency: 18,000 operations per hour) DC coil: 20 million times min. (operating frequency: 18,000 operations per hour)
Operating temperature (*3)	-40 to +70°C (no freezing)		
Operating humidity	5 to 85%RH (no condensation)		
Storage temperature	-40 to +85°C (no freezing)		
Storage humidity	5 to 85%RH (no condensation)		
Weight (approx.)	19g		

• Above values are initial values.

*1) Measured using 5V DC, 1A voltage drop method

*2) Measured at the rated voltage (at 20°C), excluding contact bounce time.

The recovery time of relays with diode is 20ms max.

The recovery time of relays with RC circuit is 20ms max.

*3) When 100% of the rated voltage is applied

Applicable socket

Type	Part No.		
	For RJ1S (1-pole)	For RJ2S (2-pole)	For RJ22S (2-pole)
Standard screw terminal	SJ1S-05BS	SJ2S-05BS	
Finger-safe screw terminal	SJ1S-07L	SJ2S-07L	
Push-in terminal	SJ1S-21L	SJ2S-21L	

Dimensions

All dimensions in mm.

RJ1S

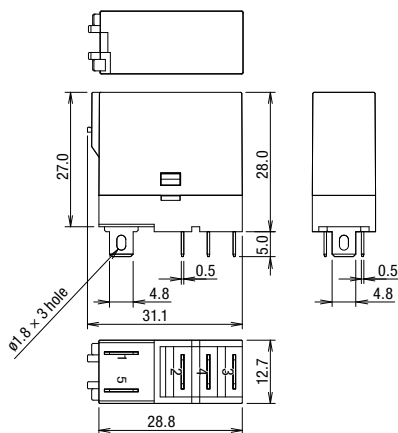

RJ2S, RJ22S

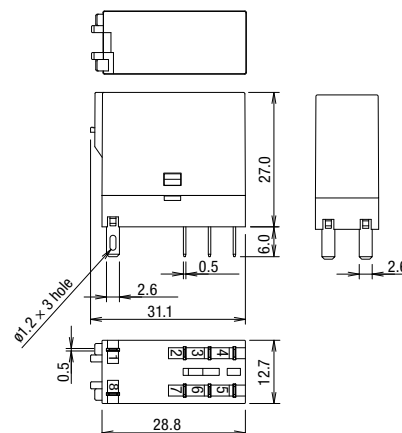

Internal connection (Bottom View)

RJ1S-CL-□ Standard (with LED indicator)

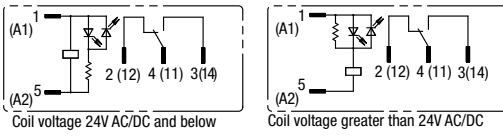

RJ2S-CL-□ / RJ22S-CL-□ Standard (with LED indicator)

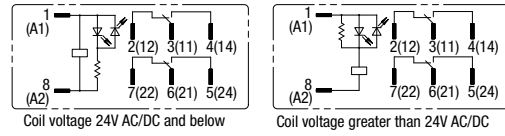

RJ1S-C-□ Simple

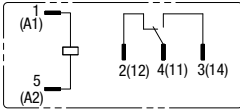

RJ2S-C-□ / RJ22S-C-□ Simple

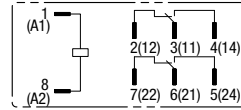

RJ1S-CLD-□ With forward polarity diode (with LED indicator)

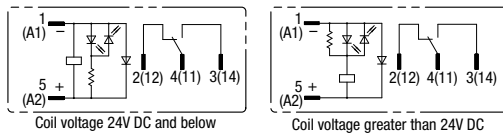

RJ2S-CLD-□ / RJ22S-CLD-□ With forward polarity diode (with LED indicator)

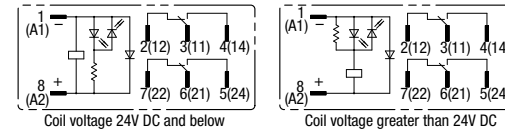

RJ1S-CD-□ With forward polarity diode

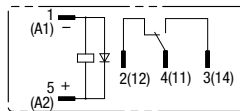

RJ2S-CD-□ / RJ22S-CD-□ With forward polarity diode

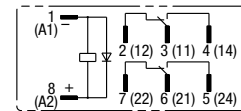

RJ1S-CLD1-□ With reverse polarity diode (with LED indicator)

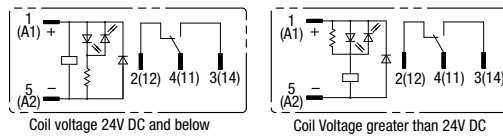

RJ2S-CLD1-□ / RJ22S-CLD1-□ With reverse polarity diode (with LED indicator)

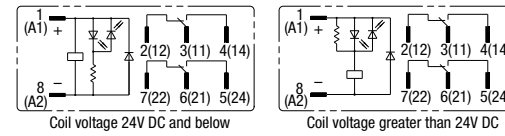

RJ1S-CD1-□ With reverse polarity diode

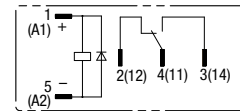

RJ2S-CD1-□ / RJ22S-CD1-□ With reverse polarity diode

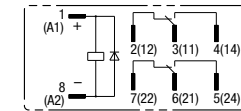

RJ1S-CLR-□ With RC circuit (with LED indicator)

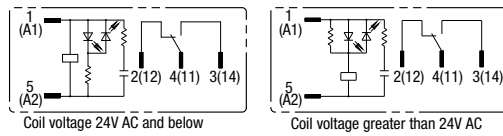

RJ2S-CLR-□ / RJ22S-CLR-□ With RC circuit (with LED indicator)

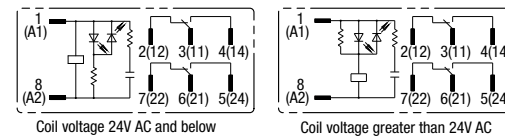

RJ1S-CR-□ With RC circuit

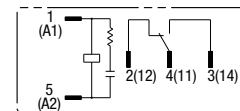

RJ2S-CR-□ / RJ22S-CR-□ With RC circuit

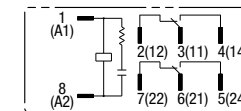

Characteristics (reference)

Electrical life curve

RJ1S

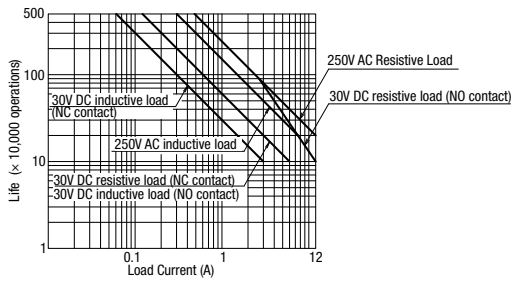

RJ2S

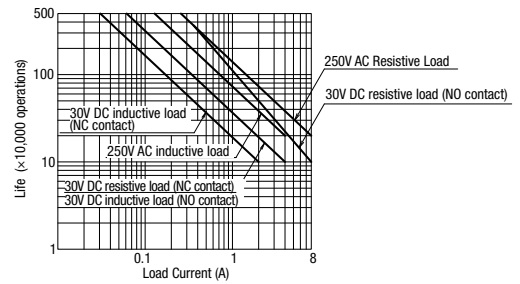

Maximum operation capacity

RJ1S

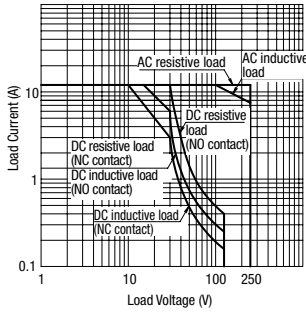

RJ2S

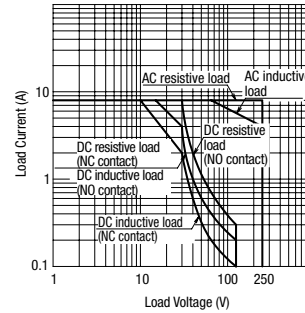

Characteristics (reference)

Ambient temperature and coil temperature rise

RJ1S

Note) When the rated coil voltage (100%) is applied. 3 rated coil is at 100% for the higher voltage.
 100V AC (50Hz), 110V AC (60Hz) when 100-(110)V.
 200V AC (50Hz), 220V AC (60Hz). when 100-(220)V.

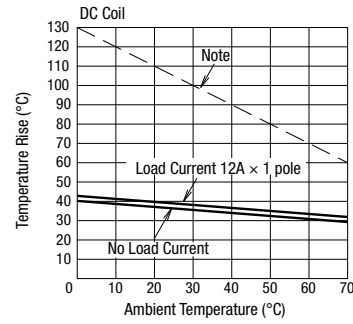
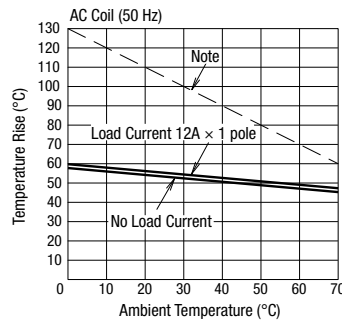
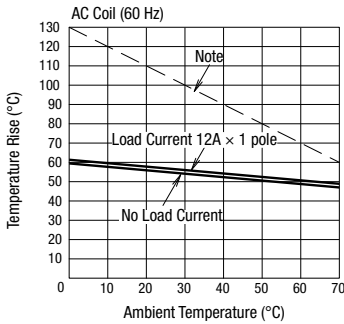

RJ2S

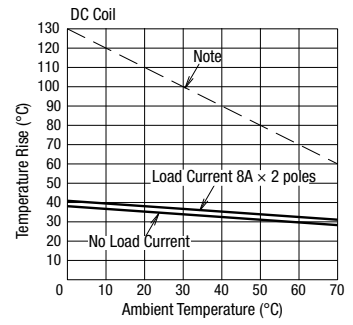
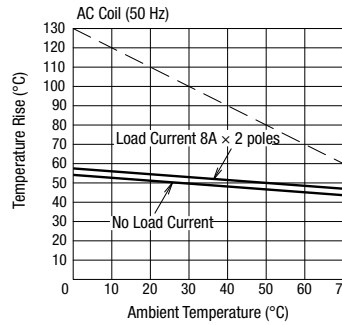
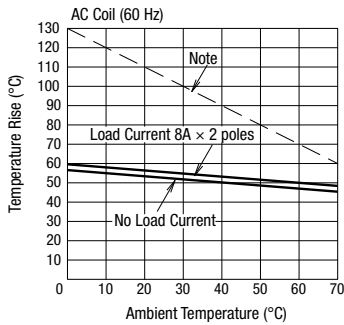

RJ22S

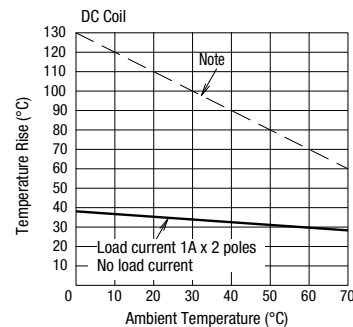
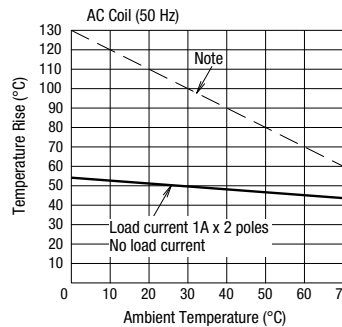
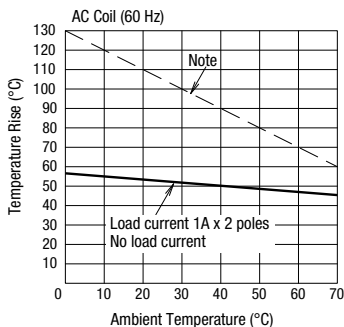

Note: The dashed lines indicate the allowable temperature rise of the coil at different ambient temperatures.

⚠ Safety Precautions

- Turn off the power to the product before starting installation, removal, wiring, maintenance, and inspection of the products. Failure to turn power off may cause electrical shock or fire.
- Be sure to use the product within the rated specifications. Failure to turn power off may cause electrical shock or fire.
- For wiring, use wires of proper size to meet voltage and current requirements. Tighten the terminal screws to the recommended tightening torque.

Instructions

1. Driving Circuit for Relays

1) To make sure of correct relay operation, apply rated voltage to the relay coil.

2) Input voltage for DC coil:

A complete DC voltage is best for the coil power to make sure of stable operation. When using a power supply containing a ripple voltage, suppress the ripple factor within 5%. When power is supplied through a rectification circuit, relay operating characteristics, such as pickup voltage and dropout voltage, differ on the ripple factor. Connect a smoothing capacitor to check the characteristics, as shown below.

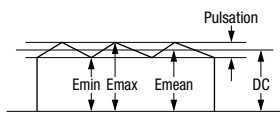
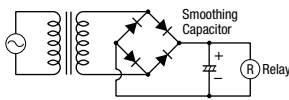

$$\text{Ripple Factor (\%)} = \frac{E_{\text{max}} - E_{\text{min}}}{E_{\text{mean}}} \times 100\%$$

E_{max} = Maximum of pulsating current
 E_{min} = Minimum of pulsating current
 E_{mean} = DC mean value

3) Operating the relay in sync with an AC load:

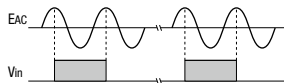
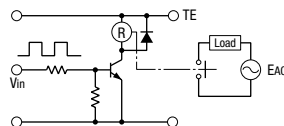

- If the relay operates in sync with the relay contact, the relay life may be reduced. If this is the case, select a relay in consideration of the required reliability for the load, or make the relay turn on and off irrespective of the AC power phase or near the point where the AC phase crosses zero voltage.

4) Leakage current while relay is off:

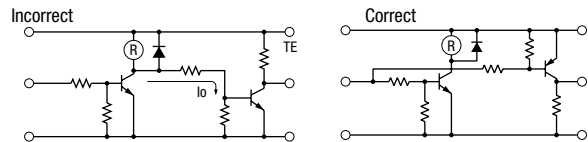

When driving an element at the same time as the relay operation, special consideration is needed for the circuit design. As shown in the incorrect circuit below, leakage current (I_o) flows through the relay coil while the relay is off. Leakage current causes the coil release failure or adversely affects the vibration resistance and shock resistance.

Design a circuit as shown in the correct example.

5) Surge suppression for transistor driving circuits:

When the relay coil is turned off, a high-voltage pulse is generated, causing the transistor to deteriorate and sometimes to break. Be sure to connect a diode to suppress the counter electromotive force. Then, the coil release time becomes slightly longer. To shorten the coil release time, connect a Zener diode between the collector and emitter of the controlling transistor. Select a Zener diode with a Zener voltage slightly higher than the power voltage.

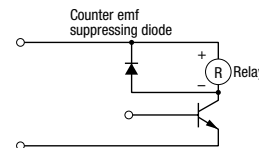

Instructions

2. Protection for relay contacts

1. The contact ratings show maximum values. Make sure that these values are not exceeded even momentarily. When an inrush current flows through the load, the contact may become welded. If this is the case, connect a contact protection circuit, such as a current limiting resistor.

2. Contact protection circuit

When switching an inductive load, arcing causes carbides to form on the contacts, resulting in increased contact resistance. In consideration of contact reliability, contact life, and noise suppression, the use of a surge absorbing circuit is recommended. Note that the release time of the load becomes slightly longer. Check the operation using an actual load.

Incorrect use of a contact protection circuit will adversely affect switching characteristics. Typical examples of contact protection circuits are shown in the following table:

RC		This protection circuit can be used when the load impedance is smaller than the RC impedance in an AC load power circuit. R: Resistor of approximately the same resistance value as the load C: 0.1 to 1 μF
		This protection circuit can be used for both AC and DC load power circuits. R: Resistor of approximately the same resistance value as the load C: 0.1 to 1 μF
Diode		This protection circuit can be used for DC load power circuits. Use a diode with the following ratings. Reverse withstand voltage: Power voltage of the load circuit × 10 Forward current: More than the load current
Varistor		This protection circuit can be used for both AC and DC load power circuits. For a best result, when using on a power voltage of 24 to 48V AC/DC, connect a varistor across the load. When using on a power voltage of 100 to 240V AC/DC, connect a varistor across the contacts.

3. Do not use a contact protection circuit as shown below.

	This protection circuit is very effective in arc suppression when opening the contacts. But, the capacitor is charged while the contacts are opened. When the contacts are closed, the capacitor is discharged through the contacts, increasing the possibility of contact welding.
	This protection circuit is very effective in arc suppression when opening the contacts. But, when the contacts are closed, a current flows to charge the capacitor, causing contact welding.

Generally, switching a DC inductive load is more difficult than switching a DC resistive load. Using an appropriate arc suppressor will improve the switching characteristics of a DC inductive load.

3. Relay coil tape color

The color of the tape wrapped around the coil is different for each coil rated voltage. (Yellow tape shows voltage)

Coil voltage	Coil color
12V AC	yellow
24V AC	white
100-(110)V AC	yellow
110V AC	Clear
115V AC	yellow
120V AC	S (Blue)
200-(220)V AC	yellow
220V AC	(black)
230V AC	yellow
240V AC	red
5V DC	yellow
6V DC	yellow
12V DC	yellow
24V DC	G (Green)
48V DC	yellow
DC100-110V	yellow

4. Other precautions

1) General notice

- To maintain the initial performance, do not drop or provide shock to the relay.
- The relay cover cannot be removed from the base during normal operation. To maintain the initial characteristics, do not remove the relay cover.
- Use the relay in environments free from condensation, dust, sulfur dioxide (SO₂), and hydrogen sulfide (H₂S).
- Ensure that the coil applied voltage does not exceed the maximum allowable voltage and is applied continuously.

2) Connecting outputs to electronic circuits

When the output is connected to a load which responds very quickly, such as an electronic circuit, contact bouncing causes incorrect operation of the load. Take the following measures into consideration.

- Connect an integration circuit.
- Suppress the pulse voltage due to bouncing within the noise margin of the load.

3) Approved ratings may differ from the product ratings specified by IDEC depending on the certification organizations and local conditions.

4) Do not use relays in the vicinity of the strong magnetic field as this may affect relay operation.

- The type with DC diode has + - polarity.
- The surge absorbing element of surge absorbing type (DC: with diode, AC: with CR circuit) is added to absorb reverse voltage of the relay coil. If an excessive surge voltage is applied externally, the surge absorbing element may be destroyed; therefore, take separate measures to absorb the surge.

SJ Series Relay Sockets

Low-profile, space-saving sockets for RJ series relays.
Equipped with a release lever.

SJ series

Package quantity: 1

Shape			
	Push-in terminal (2-pole)	Standard screw terminal (1-pole)	Finger-safe screw terminal (1-pole)
Type	1 pole		2-pole
	Part No.		Part No.
Push-in terminal	SJ1S-21L		SJ2S-21L
Standard screw terminal	SJ1S-05BS		SJ2S-05BS
Finger-safe screw terminal	SJ1S-07L		SJ2S-07L

•Release levers are supplied with the sockets.

Ratings / Specifications

Part No.	SJ1S-21L	SJ2S-21L	SJ1S-05BS	SJ2S-05BS	SJ1S-07L	SJ2S-07L	
Rated continuous current (*1)	12A	8A	12A	8A	12A	8A	
Rated insulation voltage	300V AC/DC (*2)		250V AC/DC				
Connectable wire	Solid wire, stranded wire: 0.14 to 1.5mm ² (AWG26 to 16) Stranded wire with ferrule (without insulated cover): 0.5 to 1.5mm ² , AWG20 to 16 Stranded wire with ferrule (with insulation cover): 0.14 to 1.0mm ² , AWG26 to 18		Max. 2mm ²				
Recommended tightening torque	-		0.6 to 1.0N·m		1.0N·m		
Screw terminal shape	-		M3 Phillips screw (Self-lifting)				
Insulation resistance	100MΩ min. (500V DC megger)						
Dielectric strength	Between live and dead metal parts	2500V AC, 1 minute		2000V AC, 1 minute			
	Between contact and coil	-		4000V AC, 1 minute			
	Between contacts of the same pole	-		1000V AC, 1 minute			
	Between contacts of different poles	2500V AC, 1 minute		3000V AC, 1 minute			
Vibration resistance	Damage limits: 10 to 55Hz, amplitude 1.5mm						
Shock resistance (damage limits)	50G (when using release lever)			100G (when using release lever)			
Standard operating conditions	Operating temperature	-40 to +70°C (no freezing)					
	Operating humidity	5 to 85%RH (no condensation)					
	Storage temperature	-40 to +70°C (no freezing)			-55 to +85°C (no freezing)		
	Storage humidity	5 to 85%RH (no condensation)					
Degree of protection (screw terminal)	-		-		IP20 (IEC 60529)		
Weight (approx.)	35g	43g	27g	30g	30g	34g	

*1) See "Continuous current" on the next page before use.

*2) When RF2S forced guide relay is used, the voltage is 150V AC/DC.

Continuous current

Push-in terminal

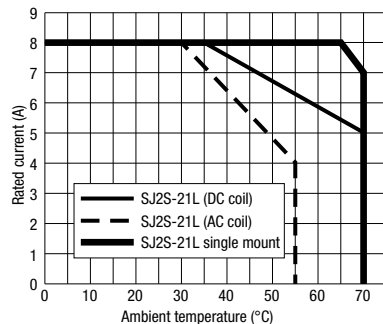
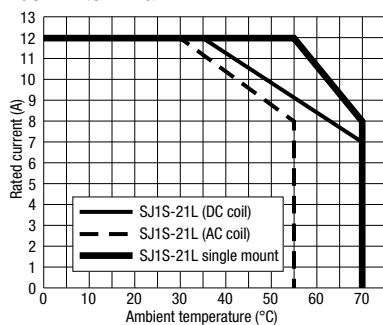

Applicable relays

Type	1-pole		2-pole	
	Socket Part No.	Applicable relays	Socket Part No.	Applicable relays
Push-in terminal	SJ1S-21L	RJ1S	SJ2S-21L	RJ2S RJ22S RF2S
Standard screw terminal	SJ1S-05BS		SJ2S-05BS	
Finger-safe screw terminal	SJ1S-07L		SJ2S-07L	

• For information on RF2 forced guided relays, see website.



Standard screw terminal

Check the current value of the relay to be mounted and use the current value listed in the table below.

Part No.	SJ1S-05BS			SJ1S-07L			SJ2S-05BS			SJ2S-07L			
Max. operating temperature	70°C	55°C	40°C	70°C	55°C	40°C	70°C	55°C	40°C	70°C	55°C	40°C	
Single mount	12A			12A			8A			8A			
Close mount	DC Relays When mounted	12A			10A (*2)			12A			8A		
	When mounting AC relays	— (*1)	12A			— (*2)	11A (*1)			— (*4)	8A		
8A													

*1) "12A" when there is a distance of 5mm min. from adjacent sockets.

*2) "12A" when there is a distance of 10mm min. from adjacent sockets.

*3) "8A" when there is a distance of 5mm min. from adjacent sockets.

*4) "8A" when there is a distance of 10mm min. from adjacent sockets.

*5) "8A" when there is a distance of 15mm min. from adjacent sockets.

Applicable crimping terminals

All dimensions in mm.

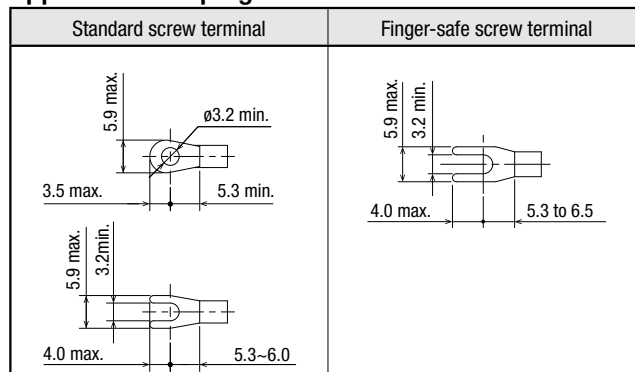

Note: Ring crimping terminals cannot be used for finger-safe screw terminals.

Accessories





When ordering, specify the Ordering No.

Type	Shape	Materials	Part No.	Ordering No.	Package quantity	Applicable model	Remarks
Marking plate		Plastic (white)	SJ9Z-P2100W	SJ9Z-P2100W	10	SJ1S-21L SJ2S-21L	—
			SJ9Z-PW	SJ9Z-PWPN10	1 (10 pcs)	SJ1S-07L SJ2S-07L	 Printable range 15.2 × 7.25mm
Jumper (*6)		Bronze (tin-plated) Coating: PBT	SU9Z-J2102A	SU9Z-J2102A	10	SJ1S-21L SJ2S-21L	The A2 terminal of the coil is cross-connected. Rated continuous current: 2A
		Brass Coating: PBT	SJ9Z-JF8S	SJ9Z-JF8S	10	SJ1S-05BS SJ2S-05BS	Terminal centers: 15.8mm Rated continuous current : 12A
		Brass (nickel plated) Coating: Polypropylene	SJ9Z-JF2	SJ9Z-JF2PN10	1 (10 pcs)	SJ1S-07L SJ2S-07L	Terminal centers: 15.5mm Rated continuous current : 12A
			SJ9Z-JF5	SJ9Z-JF5PN10			
			SJ9Z-JF8	SJ9Z-JF8PN10			
	SJ9Z-JF10		SJ9Z-JF10PN10				

*6) Ensure that the total current to the jumper does not exceed the maximum current.

Accessories





When ordering, specify the Ordering No.

Type	Shape	Materials	Part No.	Ordering No.	Package quantity	Applicable model	Remarks
DIN rail		Aluminum	BAA1000	BAA1000PN10	1 (10 pcs)		Length: 1m Width : 35mm Weight: Approx. 200g
End clip		Metal (Steel, zinc plated)	BNL6	BNL6PN10	1 (10 pcs)	SJ1S-21L SJ2S-21L SJ1S-05BS SJ2S-05BS SJ1S-07L SJ2S-07L	Weight: Approx. 15g Be sure to use an end clip to fasten multiple relay sockets on a DIN rail.
DIN rail spacer		Plastic (Black)	SA-406B	SA-406B	1		Thickness: 5mm Used for adjusting the spacing between sockets mounted on a DIN rail.
Crimping tool		-	S3TL-CR04T	S3TL-CR04T	1	SJ1S-21L SJ2S-21L	Applicable ferrule: With/without insulated cover
			S3TL-CR06D	S3TL-CR06D			
Flat blade screwdriver		-	S3TL-D04-25-75	S3TL-D04-25-75	1		Blade size a: 0.4mm b: 2.5mm c: 75mm

- For wires/ferrules compatible with Push-in terminal sockets, see p15 "Applicable wires".

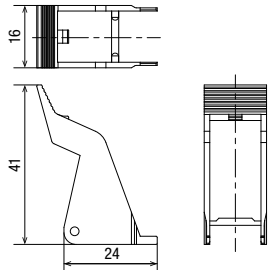
Maintenance parts

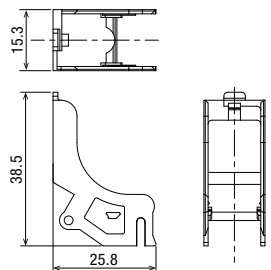
When ordering, specify the Ordering No.

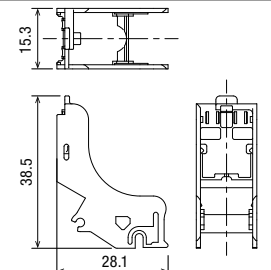
Type	Shape	Materials	Part No.	Ordering No.	Package quantity	Applicable model	Remarks
Release lever		Plastic	SJ9Z-C21R	SJ9Z-C21R	10	SJ1S-21L SJ2S-21L	
Release lever		Plastic	SJ9Z-CS	SJ9Z-CS	10	SJ1S-05BS SJ2S-05BS	
Release Lever (marking plate attachable)		Plastic	SJ9Z-CM	SJ9Z-CMPN05	1 (5 pcs)	SJ1S-07L SJ2S-07L	 When the marking plate is not used on the release lever

⚠ Safety Precautions

- Turn off the power to the product before starting installation, removal, wiring, maintenance, and inspection of the products. Failure to turn power off may cause electrical shock or fire hazard.
- Use wires of the proper size to meet the voltage and current requirements.
- Make sure that relay and output equipment are wired correctly. Incorrect wiring causes overheating, resulting in a possible fire hazard.
- Prevent metal fragments and pieces of wire from dropping inside the socket. Ingress of such fragments and chips may cause fire hazard, damage, or malfunction.

Instructions (Push-in terminal socket)

Applicable wire

When wiring, use the applicable wires shown below.

Applicable wires and specifications

Applicable wire (stranded wire, solid wire)	0.14 to 1.5mm ² (AWG16 to 26)
Wire strip length (*1)	10 to 11mm

*1) Strip the sheath of the wire 10 to 11mm from the end.
When using a ferrule, refer to "Wire size and recommended ferrules"

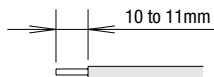

Note: Make sure that the stranded wires do not loosen when using wiring without ferrules.

Wire size and recommended ferrules

Ferrule terminals without insulation covers

Applicable wire (stranded wire, solid wire)		Wire strip length (*1)	Part No.	Ordering No.
(AWG)	mm ²			
26	0.14	10 to 11mm	S3TL-F014-12WC	S3TL-F014-12WC
24	0.25	10 to 11mm	S3TL-H025-12WJ	S3TL-H025-12WJ
22	0.34	10 to 11mm	S3TL-H034-12WT	S3TL-H034-12WT
20	0.50	10 to 11mm	S3TL-H05-14WA	S3TL-H05-14WA
		12 to 13mm	S3TL-H05-16WA	S3TL-H05-16WA
18	0.75	10 to 11mm	S3TL-H075-14WW	S3TL-H075-14WW
		12 to 13mm	S3TL-H075-16WW	S3TL-H075-16WW
18	1.00	10 to 11mm	S3TL-H10-14WY	S3TL-H10-14WY
		12 to 13mm	S3TL-H10-16WY	S3TL-H10-16WY

Inserting the wire

Stranded wires with ferrules or solid wire

- 1) Insert the wire to the back of the wire port.
- 2) Wiring is complete. Pull the wire tightly to make sure that the wire does not pull out from the socket.



Stranded wire

- 1) Push the pusher (orange button) using a flat blade screwdriver.
- 2) Insert the wire fully in the wiring port while pressing the pusher.
- 3) Release the flat blade screwdriver. Wiring is complete. Pull the wire tightly to make sure that the wire does not pull out from the socket.



Removing the wire

- 1) Push the pusher using a flat blade screwdriver.
- 2) Pull out the wire while pressing the pusher.
- 3) Release the flat blade screwdriver.



Be sure to read the instruction manual carefully before performing installation, wiring, or maintenance work.

- Push-in terminal -----<https://product.idec.com/?product=SJ2S-21L>
- Standard screw terminal 1-pole SJ1S-05BS -----<https://product.idec.com/?product=SJ1S-05BS>
- Standard screw terminal 2-pole SJ2S-05B-----<https://product.idec.com/?product=SJ2S-05BS>
- Finger safe screw terminal 1-pole SJ1S-07L-----<https://product.idec.com/?product=SJ1S-07L>
- Finger safe screw terminal 2-pole SJ2S-07L-----<https://product.idec.com/?product=SJ2S-07L>



Push-in terminal screw



Standard screw terminal 1-pole



Standard screw terminal 2-pole



Finger-safe terminal screw 1-pole



Finger-safe terminal screw 2-pole

Ordering Terms and Conditions

Thank you for using IDEC Products.

By purchasing products listed in our catalogs, datasheets, and the like (hereinafter referred to as "Catalogs") you agree to be bound by these terms and conditions. Please read and agree to the terms and conditions before placing your order.

1. Notes on contents of Catalogs

- (1) Rated values, performance values, and specification values of IDEC products listed in this Catalog are values acquired under respective conditions in independent testing, and do not guarantee values gained in combined conditions.
Also, durability varies depending on the usage environment and usage conditions.
- (2) Reference data and reference values listed in Catalogs are for reference purposes only, and do not guarantee that the product will always operate appropriately in that range.
- (3) The specifications / appearance and accessories of IDEC products listed in Catalogs are subject to change or termination of sales without notice, for improvement or other reasons.
- (4) The content of Catalogs is subject to change without notice.

2. Note on applications

- (1) If using IDEC products in combination with other products, confirm the applicable laws / regulations and standards.
Also, confirm that IDEC products are compatible with your systems, machines, devices, and the like by using under the actual conditions. IDEC shall bear no liability whatsoever regarding the compatibility with IDEC products.
- (2) The usage examples and application examples listed in Catalogs are for reference purposes only. Therefore, when introducing a product, confirm the performance and safety of the instruments, devices, and the like before use. Furthermore, regarding these examples, IDEC does not grant license to use IDEC products to you, and IDEC offers no warranties regarding the ownership of intellectual property rights or non-infringement upon the intellectual property rights of third parties.
- (3) When using IDEC products, be cautious when implementing the following.
 - i. Use of IDEC products with sufficient allowance for rating and performance
 - ii. Safety design, including redundant design and malfunction prevention design that prevents other danger and damage even in the event that an IDEC product fails
 - iii. Wiring and installation that ensures the IDEC product used in your system, machine, device, or the like can perform and function according to its specifications
- (4) Continuing to use an IDEC product even after the performance has deteriorated can result in abnormal heat, smoke, fires, and the like due to insulation deterioration or the like. Perform periodic maintenance for IDEC products and the systems, machines, devices, and the like in which they are used.
- (5) IDEC products are developed and manufactured as general-purpose products for general industrial products. They are not intended for use in the following applications, and in the event that you use an IDEC product for these applications, unless otherwise agreed upon between you and IDEC, IDEC shall provide no guarantees whatsoever regarding IDEC products.
 - i. Use in applications that require a high degree of safety, including nuclear power control equipment, transportation equipment (railroads / airplanes / ships / vehicles / vehicle instruments, etc.), equipment for use in outer space, elevating equipment, medical instruments, safety devices, or any other equipment, instruments, or the like that could endanger life or human health
 - ii. Use in applications that require a high degree of reliability, such as provision systems for gas / waterworks / electricity, etc., systems that operate continuously for 24 hours, and settlement systems
 - iii. Use in applications where the product may be handled or used deviating from the specifications or conditions / environment listed in the Catalogs, such as equipment used outdoors or applications in environments subject to chemical pollution or electromagnetic interference
If you would like to use IDEC products in the above applications, be sure to consult with an IDEC sales representative.

3. Inspections

We ask that you implement inspections for IDEC products you purchase without delay, as well as thoroughly keep in mind management/maintenance regarding handling of the product before and during the inspection.

4. Warranty

(1) Warranty period

The warranty period for IDEC products shall be one (1) year after purchase or delivery to the specified location. However, this shall not apply in cases where there is a different specification in the Catalogs or there is another agreement in place between you and IDEC.

(2) Warranty scope

Should a failure occur in an IDEC product during the above warranty period for reasons attributable to IDEC, then IDEC shall replace or repair that product, free of charge, at the purchase location / delivery location of the product, or an IDEC service base. However, failures caused by the following reasons shall be deemed outside the scope of this warranty.

- i. The product was handled or used deviating from the conditions / environment listed in the Catalogs
 - ii. The failure was caused by reasons other than an IDEC product
 - iii. Modification or repair was performed by a party other than IDEC
 - iv. The failure was caused by a software program of a party other than IDEC
 - v. The product was used outside of its original purpose
 - vi. Replacement of maintenance parts, installation of accessories, or the like was not performed properly in accordance with the user's manual and Catalogs
 - vii. The failure could not have been predicted with the scientific and technical standards at the time when the product was shipped from IDEC
 - viii. The failure was due to other causes not attributable to IDEC (including cases of force majeure such as natural disasters and other disasters)
- Furthermore, the warranty described here refers to a warranty on the IDEC product as a unit, and damages induced by the failure of an IDEC product are excluded from this warranty.

5. Limitation of liability

The warranty listed in this Agreement is the full and complete warranty for IDEC products, and IDEC shall bear no liability whatsoever regarding special damages, indirect damages, incidental damages, or passive damages that occurred due to an IDEC product.

6. Service scope

The prices of IDEC products do not include the cost of services, such as dispatching technicians. Therefore, separate fees are required in the following cases.

- (1) Instructions for installation / adjustment and accompaniment at test operation (including creating application software and testing operation, etc.)
- (2) Maintenance inspections, adjustments, and repairs
- (3) Technical instructions and technical training
- (4) Product tests or inspections specified by you

The above content assumes transactions and usage within your region. Please consult with an IDEC sales representative regarding transactions and usage outside of your region. Also, IDEC provides no guarantees whatsoever regarding IDEC products sold outside your region.

IDEC CORPORATION

Head Office 6-64, Nishi-Miyahara-2-Chome, Yodogawa-ku, Osaka 532-0004, Japan

USA IDEC Corporation
EMEA APEM SAS

Singapore IDEC Izumi Asia Pte. Ltd.
Thailand IDEC Asia (Thailand) Co., Ltd.
India IDEC Controls India Private Ltd.

China IDEC (Shanghai) Corporation
IDEC Izumi (H.K.) Co., Ltd.
Taiwan IDEC Taiwan Corporation

Japan IDEC Corporation

 www.idec.com