



# Designing systems for low safety risk levels

Easily build systems to satisfy the requirements  
for Category 2

# Safety measures for low risk machines

## Category 2 Safety Relay Module



Food machines

Creating a safety system for machines with different levels of risk

Mounting device for electrical components



Packaging machines



Semiconductor manufacturing equipment



Collaborative robots



Pharmaceutical manufacturing equipment



## Non-redundant safety system

### Introducing a safety system for low risk machines

Designing a category 2 system has been difficult and only a redundant system (category 3) could be used to protect machines against relatively minor hazards.

However, with the HR5S safety relay module, designing a category 2 system is easy and enables cost reduction and saves maintenance time.

### Category 3 and category 2 comparison

#### Category 3 example - When using IDEC safety relay module HR6S-AF



#### Category 3 system configuration

- Dual channel circuit with cross monitoring
- A single fault does not lead to the loss of the safety function

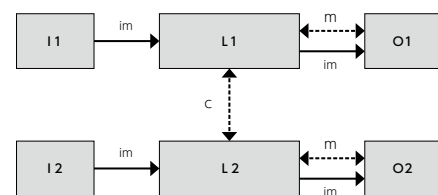

im: interconnecting means I1, I2: input device L1, L2: Logic processing  
m: monitoring O1, O2: Output device

Dashed lines for monitoring represent reasonably practicable fault detection

\*According to ISO13849-1

#### Category 2 example - When using IDEC safety relay module HR5S

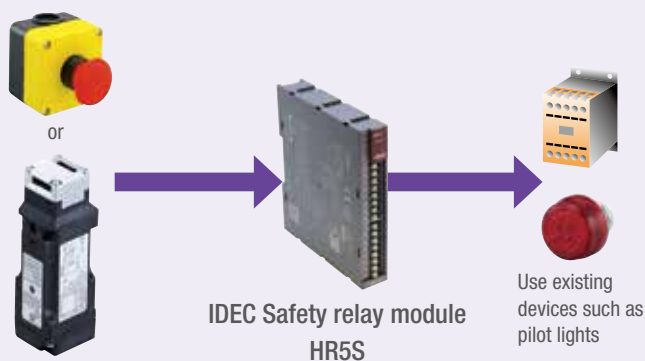

#### Category 2 system configuration

- The circuit is monitored but the output device does not require redundancy.
- If the safety function is impaired due to failure, the alarm (light or buzzer) is output by a fault detection signal. (In the case of a PLC system)

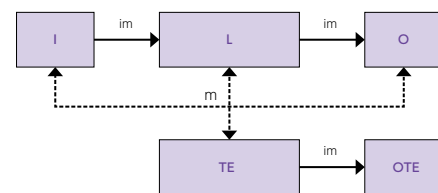

im: interconnecting means I2: input device L2: Logic processing  
m: monitoring O: output device TE: Testing equipment  
OTE: Output of testing equipment

Dashed lines represent reasonably practicable fault detection

\*According to ISO13849-1

- Category is an architecture for safety control defined in ISO13849-1.

# Performance level

Degree of contribution to risk reduction in a safety system is categorized by performance levels.

In category 2 architecture, PL=c or PL=d control system can be achieved.

Risk assessment must be performed to check the performance level (PLr) required for the equipment.

PLr=C exists especially in food and packaging machines, semiconductor manufacturing equipment, and other production equipment and locations.

Relationship between category (Cat.), DC, MTTFD, and PL

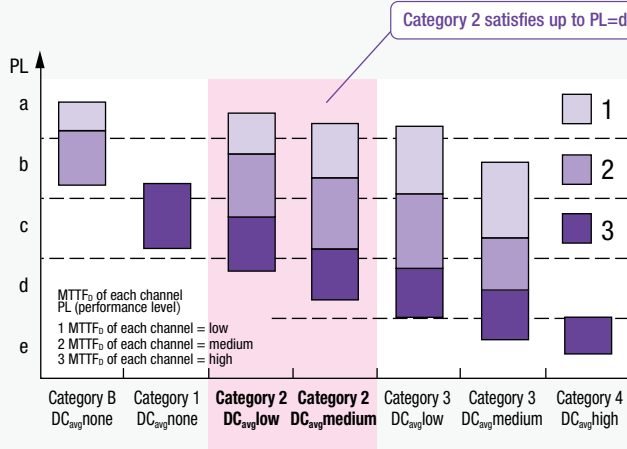

PL is determined by the combination of the architecture (Cat.), Mean Time to Dangerous Failure (MTTF<sub>D</sub>), and Diagnostic Coverage (DC<sub>avg</sub>) of the system.

The illustration shows that the PL that can be achieved by combining Cat., MTTFD, and DC<sub>avg</sub>. The HR5S can construct a category 2 system so it can satisfy PL=a to d levels.

## Determining PLr

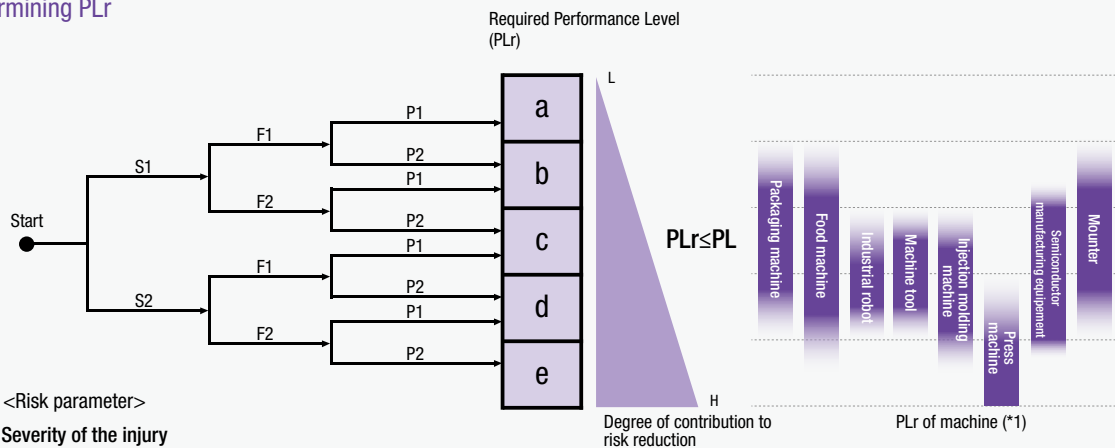

<Risk parameter>

**S Severity of the injury**

- S1 Minor injury (resulting in a full recovery)
- S2 Serious injury (resulting in a permanent disability)

**F Frequency and duration of exposure to the hazard**

- F1 Seldom to quite often, and/or short exposure time (15min. per sec maximum and 1/20 maximum of that operating time of the machine)
- F2 Frequent to continuous and/or long exposure time

**P Possibility of avoiding the hazard (depending on the occurrence speed of danger, ability to escape, and training)**

- P1 Possible under specific conditions
- P2 Scarcely possible

\*1) The performance level is mapped according to the sales achievement of IDEC safety products, results of risk assessment, and request for international standards. The required performance level for machines should be determined by risk assessment of individual machines.

## Performance of Category 2 system

System that eliminates short-circuit fault detection when wiring from an input device



**Total width**  
**41% DOWN**

**Cost**  
**45% DOWN**

System with off-delay control system





**Total width**  
**52% DOWN**

**Cost**  
**39% DOWN**

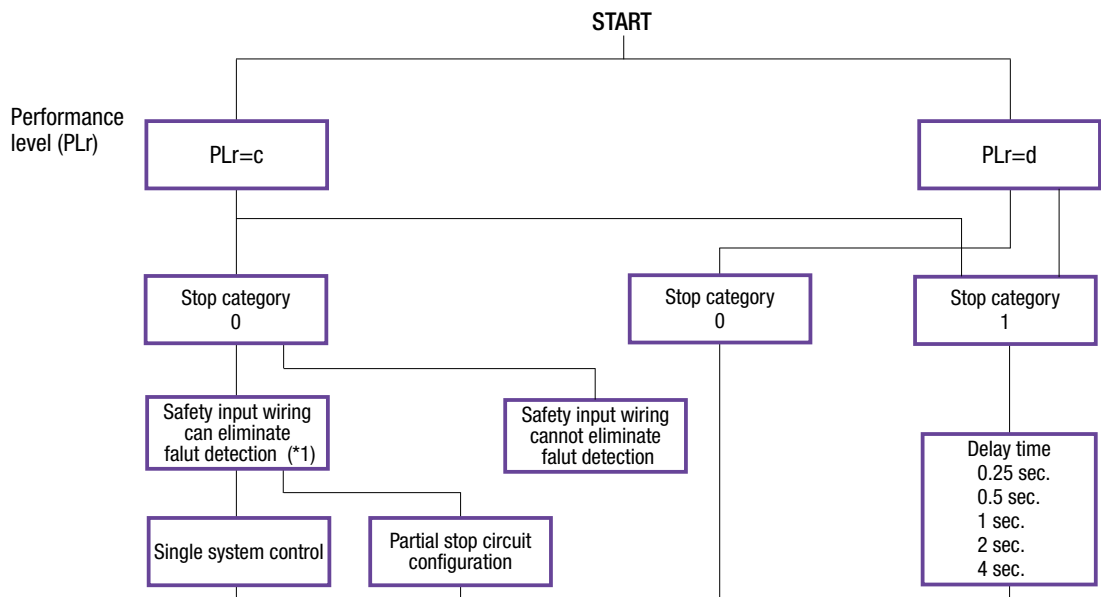
## Product Selection Selection process flow chart & line up



		 Simple model	 Standard model	 Off-delay model
Part number		HR5S-C2S (*1)	HR5S-C2B	HR5S-C2D-T025 HR5S-C2D-T050 HR5S-C2D-T100 HR5S-C2D-T200 HR5S-C2D-T400
Maximum applicable PL		c	d	d
Features		Minimum functions	<ul style="list-style-type: none"> <li>Input monitor available</li> <li>Equipped with output that turns off when fault is detected</li> <li>Equipped with fault detection input and can construct partial stop circuit.</li> </ul>	<ul style="list-style-type: none"> <li>One of the safety outputs of the standard type changed to delay output</li> <li>Off-delay, 5 models (0.25s, 0.5s, 1s, 2s, 4s)</li> </ul>
Input	Safety input	1	1	1
	Switch monitor input	Not available	Available	Available
	Fault monitor input	Not available	Available	Available
Output	Safety output	2	2	Not available
	Auxiliary output	Not available	Not available	1
	Delay safety output	Not available	Not available	1
Fault detection output	ON output (Fault monitor output)	Available	Available	Available
	OFF output (Fault detection output)	Not available	Available	Available
Start		Manual/Automatic	Manual/Automatic	Manual/Automatic
Fault detection release		Manual	Manual	Manual

\*1) Can be used in cases where failures caused by cables can be eliminated according to ISO13849-2, IEC60204-1 by using cable covers and shield cables.

# HR5S Safety Relay Module

Category 2 safety relay modules for machines that require protection against minor hazards.



• See website for details on approvals and standards.



## HR5S Safety Relay Module

Package Quantity: 1

Type	Performance level (PL)	Contact Configuration	Reaction time		Part No. (Ordering No.)
			Output without OFF-delay	Output with OFF-delay	
Simple	PL=c	2NO (Without OFF-delay): Safety output	0.02s max.	—	HR5S-C2S
Standard	PL=d			HR5S-C2B	
OFF-delay	PL=d	1NO (Without OFF-delay): Auxiliary output + 1NO (With OFF-delay): Safety output	0.02s max.	0.25s ± 0.05s	HR5S-C2D-T025
				0.50s ± 0.07s	HR5S-C2D-T050
				1.00s ± 0.10s	HR5S-C2D-T100
				2.00s ± 0.15s	HR5S-C2D-T200
				4.00s ± 0.20s	HR5S-C2D-T400

## Maintenance Parts

Package Quantity: 1

Type	Part No. (Ordering No.)	Remarks
Bracket for direct mounting	HR5S-PSP	Direct mount

## Dimensions

(All dimensions in mm)

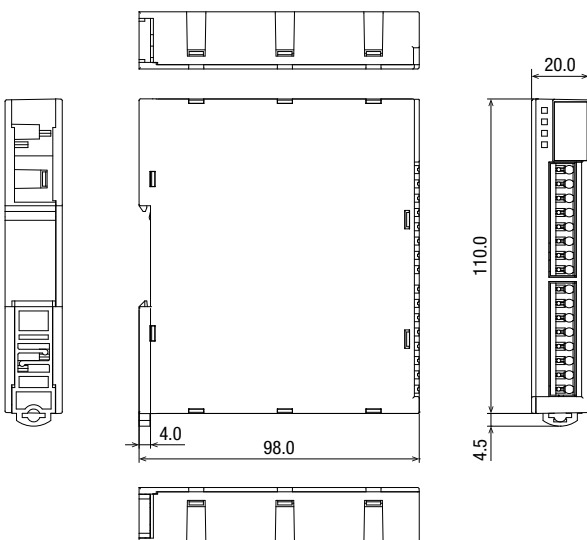

## Specifications

Type No.	HR5S-C2S	HR5S-C2B	HR5S-C2D-T□□□
Applicable standards	EN ISO13849-1: 2023, EN ISO13849-2: 2012, EN 60947-5-1: 2017, UL 508, CSA C22.2 No.14, GB/T 14048.5		
Performance level (PL) (EN ISO 13849-1)	PL=c	PL=d	
Category (Cat.)	2 (EN ISO 13849-1)		
Mean time to dangerous failure (MTTF <sub>D</sub> )	330 years (100 years: When the limit value from EN ISO 13849-1 is applied) (MTTF <sub>D</sub> of fault output: 210 years)		
Diagnostics coverage (DC <sub>avg</sub> )	Medium (90% minimum) (EN ISO 13849-1)		
Mission time (T <sub>M</sub> )	20 years (EN ISO 13849-1)		
Stop category (EN 60204-1: 2018)	0	1 (Safety output 2 with OFF-delay) (*1) 0 (Auxiliary output 1 without OFF-delay)	
Rated operating voltage	24V DC (Tolerance -15% to +10%), Class 2 Only (For North America)		
Current consumption	100mA maximum at 24V DC (Without load)		
Input (*2)	30Ω maximum (Between S11 to S□□ *□□ : 12, 13, 14, 34, 35, 36)		
	—	30Ω max.(Between Y1 of the previous module to S15)	
Safety output / Auxiliary output (*2)	Configuration	2NO (Without OFF-delay): Safety output	1NO (Without OFF-delay): Auxiliary output + 1NO (With OFF-delay): Safety output
	Initial contact resistance	200mΩ maximum each output contact (*3)	
	Rated load (resistive load)	250V AC 3A / contact, 30V DC 3A / contact	
	Maximum operational voltage	250V AC, 30V DC	
	Minimum applicable load	5V DC, 1mA (reference value) [Failure rate level P (reference value)]	
	Electrical life	250V AC 3A resistive load: 100,000 operations minimum (*4), 30V DC 3A resistive load: 100,000 operations minimum (*4) 250V AC 1A resistive load: 500,000 operations minimum (*5), 30V DC 1A resistive load: 500,000 operations minimum (*5) [AC-15] 240V AC 2A inductive load: 100,000 operations minimum (operating frequency 1200 per hour, cosφ= 0.3) [DC-13] 24V DC 1A inductive load: 100,000 operations minimum (operating frequency 1200 per hour, L/R = 48ms)	
		Mechanical life	10 million operations minimum (operating frequency 10,800 per hour)
Conditional short-circuit current	1,000A External fuse: 5A FH (IEC 60127-2)		
Fault Output (*2)	Fault monitor output	Semiconductor output, rated 24V DC 100mA maximum	
	Fault detection output	—	Semiconductor output, rated 24V DC 100mA max.
Reaction time (*6) (*7)	0.02s maximum	<ul style="list-style-type: none"> <li>Output with OFF-delay</li> <li>D - T025 (0.25s): 0.25s ± 0.05s</li> <li>D - T050 (0.5s): 0.50s ± 0.07s</li> <li>D - T100 (1s): 1.00s ± 0.10s</li> <li>D - T200 (2s): 2.00s ± 0.15s</li> <li>D - T400 (4s): 4.00s ± 0.20s</li> <li>Output without OFF-delay: 0.02s max.</li> </ul>	
Response time by failure diagnosis function (*8)	Detection by EDM	0.25s maximum	<ul style="list-style-type: none"> <li>D - T025 (0.25s): 0.5s maximum</li> <li>D - T050 (0.5s): 0.8s maximum</li> <li>D - T100 (1s): 1.3s maximum</li> <li>D - T200 (2s): 2.4s maximum</li> <li>D - T400 (4s): 4.5s maximum</li> </ul>
	Detection by SW monitor	—	0.6s maximum
Turn ON time (*7)	0.05s maximum		
Operating temperature (*9)	-10 °C to +55 °C (no freezing, no condensation)		
Operating humidity	5 % RH to 85% RH (no condensation)		
Storage temperature	-25 °C to +85 °C (no freezing, no condensation)		
Storage humidity	5 % RH to 85% RH (no condensation)		
Altitude	Operation: 0 to 2,000m		
Operating atmosphere	Indoor use only (atmosphere free from corrosive gases)		
IP (protective structure specification)	Enclosure: IP40, Terminals: IP20		
Pollution degree	2		
Over voltage category	II		
Insulation	Basic insulation (reinforced insulation: between contact output circuits and other circuits)		
Rated insulation voltage	250V (contact outputs)		
Rated impulse withstand voltage	2,500V (between different terminal contact outputs) (4,000V: between contact output circuits and other circuits)		
Dielectric strength (1 minute)	3,750V AC (between enclosure and internal circuit), 2,500V AC (between different terminal contact outputs) (between contact output circuits and other circuits)		
Vibration resistance	5 Hz to 8.4 Hz: 3.5 mm amplitude, 8.4 Hz to 150 Hz: 10 m/s <sup>2</sup> peak, 1 octave/min, 10 cycles for 3 axes		
Shock resistance	150 m/s <sup>2</sup> , pulse width: 11 msec, 3 times for 6 directions		
Mounting	DIN rail or panel mounting		
Terminal Style	Push-in terminals		
Weight (approx.)	150g		

\*1) "Stop category 1" of EN 60204-1: 2018 is compliant to "SS1-t" of EN 61800-5-2: 2017.

\*2) The external wiring length for inputs and outputs must be less than 30m maximum.

\*3) Measured using 6V DC, 1A voltage drop method.

\*4) Operating frequency 1200 per hour

\*5) Operating frequency 1800 per hour

\*6) The interval between when the safety input (S12) turns OFF and safety output contacts and/or the auxiliary output contact turn OFF.

\*7) When measured at the rated voltage (at 20°C). Excluding contact bounce time.

\*8) The interval between when the safety relay module detects a fault and the fault monitor output (Y1) turns ON, and the fault detection output (Y2) turns OFF at the same time.

\*9) UL approved operating temperature is 40°C maximum when the product is installed in a control panel.

- The performance level and the category in accordance with EN ISO 13849-1 depends on the external wiring, application, control device used, and location in the equipment.
- The user must carry out a risk assessment in accordance with ISO 12100.
- The entire system/machine must be validated in accordance with the applicable standards.
- The safety relay module contains electromechanical relays. Therefore the shown performance level and MTTF<sub>D</sub> value depend on the load and the operating cycles in the application. The above mentioned performance level and MTTF<sub>D</sub> values are suitable for nominal load of maximum 8,760 switching cycles per year or for small load of maximum 525,600 switching cycles per year.

Parts Description and Definition of Terminals

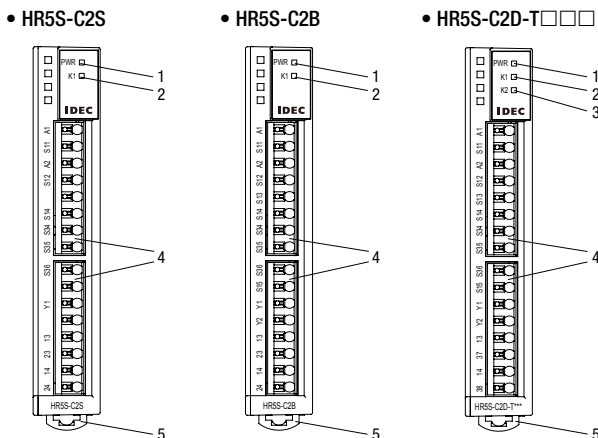

Parts No.	Parts Name and Functions
1	PWR LED: Indicates power supply
2	K1 LED: Indicates safety output(s) (or auxiliary output) without OFF-delay
3	K2 LED: Indicates safety output with OFF-delay
4	Push-in terminal
5	DIN Rail mounting hook

Product type symbol			Terminal no.	Terminal name	Function
S	B	D			
✓	✓	✓	A1, A2	Power supply	24V DC power supply (A1: 24V DC, A2: 0V)
✓	✓	✓	S11	Input driver	24V DC output for safety input, reset inputs, switch monitor input, and EDM input
✓	✓	✓	S12	Safety input	NC contacts of switches with a direct opening action mechanism or and interlock switch (such as coded switches) connects between S11 and S12.
	✓	✓	S13	Switch monitor input	Connect NO contacts of interlock switches (such as non-contact safety switches) between S11 and S13. When not used, do not connect S13.
✓	✓	✓	S14	EDM input	Connect NC contacts of external contactors between S11 and S14.
	✓	✓	S15	Fault monitor input	Connect fault monitor output (Y1) of the previous HR5S module. When not used, do not connect S15.
✓	✓	✓	S34	Manual reset input	Connect a switch between S11 and S34. Only a rising edge followed by a falling edge triggers the reset event.
✓	✓	✓	S35	Auto reset input	Connect a switch between S11 and S35. A rising edge triggers the reset event.
✓	✓	✓	S36	Fault reset input	Connect a switch between S11 and S36. Only a rising edge followed by a falling edge triggers the fault reset event. When the fault reset event is triggered after a failure is cleared, the fault detection output (Y2) turns ON from OFF and the fault monitor output (Y1) turns OFF from ON.
✓	✓		13 - 14	Safety output 1 Without OFF-delay	The contact configuration is NO. The contact is a part of the force guided relay (K1) embedded in HR5S.
		✓		Auxiliary output 1 Without OFF-delay	
✓	✓		23 - 24	Safety output 2 Without OFF-delay	The contact configuration is NO. The contact is a part of the force guided relay (K1) embedded in HR5S.
		✓	37 - 38	Safety output 2 With OFF-delay	The contact configuration is NO. The contact is a part of the force guided relay (K2) embedded in HR5S.
✓	✓	✓	Y1	Fault monitor output	The output is kept on high level (Typ. 24VDC) when the safety relay module detects a fault. (Semiconductor output)
	✓	✓	Y2	Fault detection output	The output is kept on low level (Typ. 0V) when the safety relay module detects a fault. (Semiconductor output)



## Wiring Examples

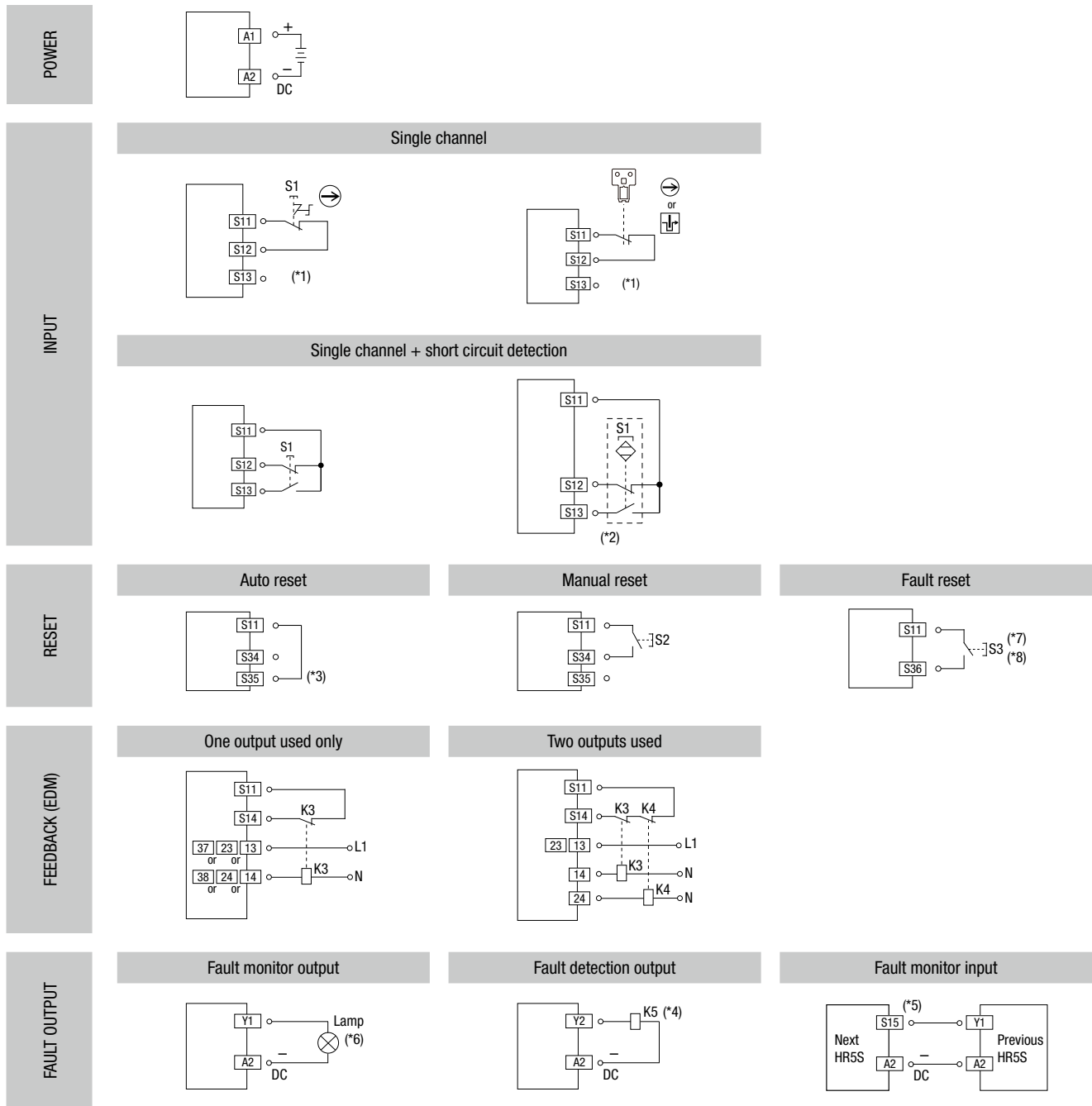

\*1) When the switch monitor input (S13) is not used, it is necessary to exclude a short circuit between the cable of safety input (S12) and other cables (e.g. to protect the cables and/or to shield the cables).

\*2) Illustrates contact status when actuator exists.

\*3) When the auto reset input (S35) is used, risk assessment must be performed to prevent an unexpected activation. In this case, the manual reset input (S34) must not be used.

\*4) The fault detection output (Y2) turns OFF when a fault is detected, i.e. it is possible for K5 (e.g. a contactor) to stop the hazardous source (e.g. a motor).

\*5) The fault monitor input (S15) can be connected to the fault monitor output (Y1) of previous module (HR5S). This means that K5 (e.g. a contactor) can be used to stop the hazardous source (e.g. a motor)

\*6) Leakage currents of the fault output may cause the LED lamp to illuminate dimly even when the output is off. In this case, insert a shunt resistor with the LED lamp.

\*7) S36 does not require wiring when fault reset is performed by turning on the power again.

\*8) Manual reset switch S2 can be used as a fault reset switch S3. When doing so, be sure to perform risk assessment

### Wiring Diagram (Typical application)

#### HR5S-C2S

The maximum achievable PL is "c".  
 (In the figure below, the manual reset input (S34) is used.)

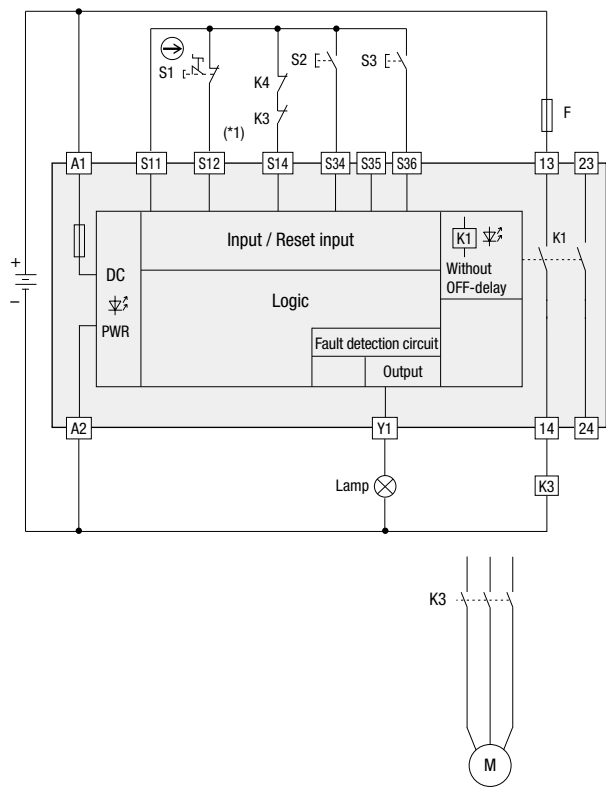

- S1: Emergency stop switch
- S2: Reset switch for start
- S3: Reset switch for a fault
- K1: Force guided relay installed in the module
- K3: Contactor
- M: Motor
- F: External fuse

\*1) It is necessary to exclude a short circuit between the cable of safety input (S12) and other cables (e.g. to protect the cables and/or to shield the cables).

Timing Chart

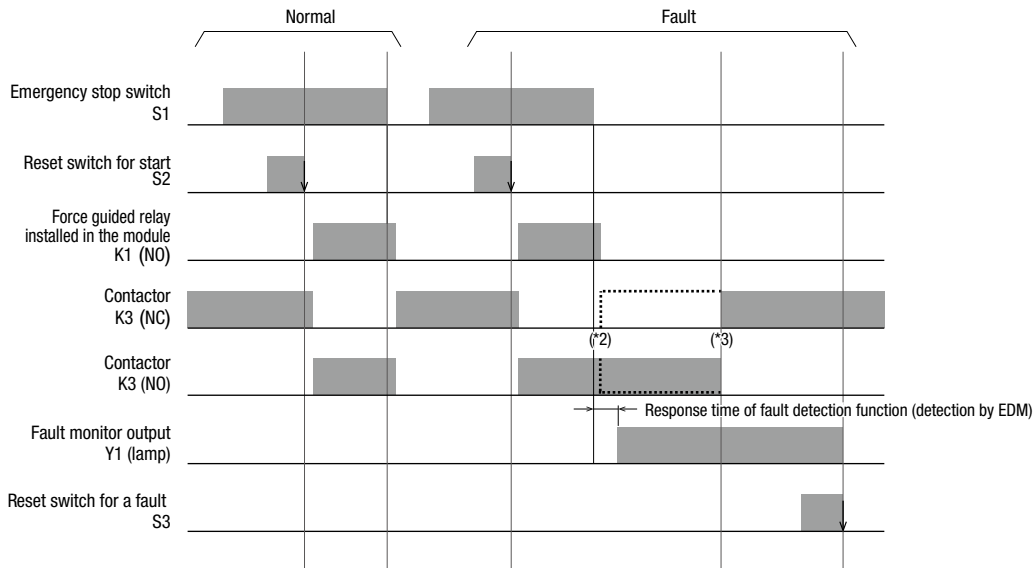

\*2) Welding fault occurred with contactor K3  
 \*3) Fault removed

### Wiring Diagram (Typical application)

#### HR5S-C2B

The maximum achievable PL is "d".

(In the figure below, the manual reset input (S34) is used.)

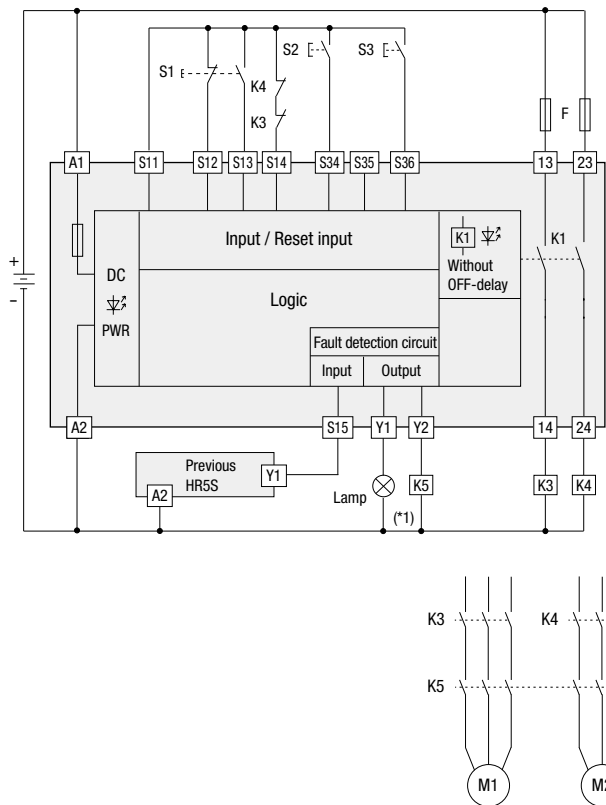

- S1 : Emergency stop switch
- S2 : Reset switch for start
- S3 : Reset switch for a fault
- K1 : Force guided relay installed in the module
- K3, K4, K5 : Contactor
- M1, M2 : Motor
- F : External fuse

\*1) When PL is c for fault monitor output Y1 and fault detection output Y2, connect a warning lamp to Y1 (on during fault detection).  
When PL is d, connect a contactor K5 to shut power of the hazardous source to Y2 (off during fault detection).

#### Timing Chart

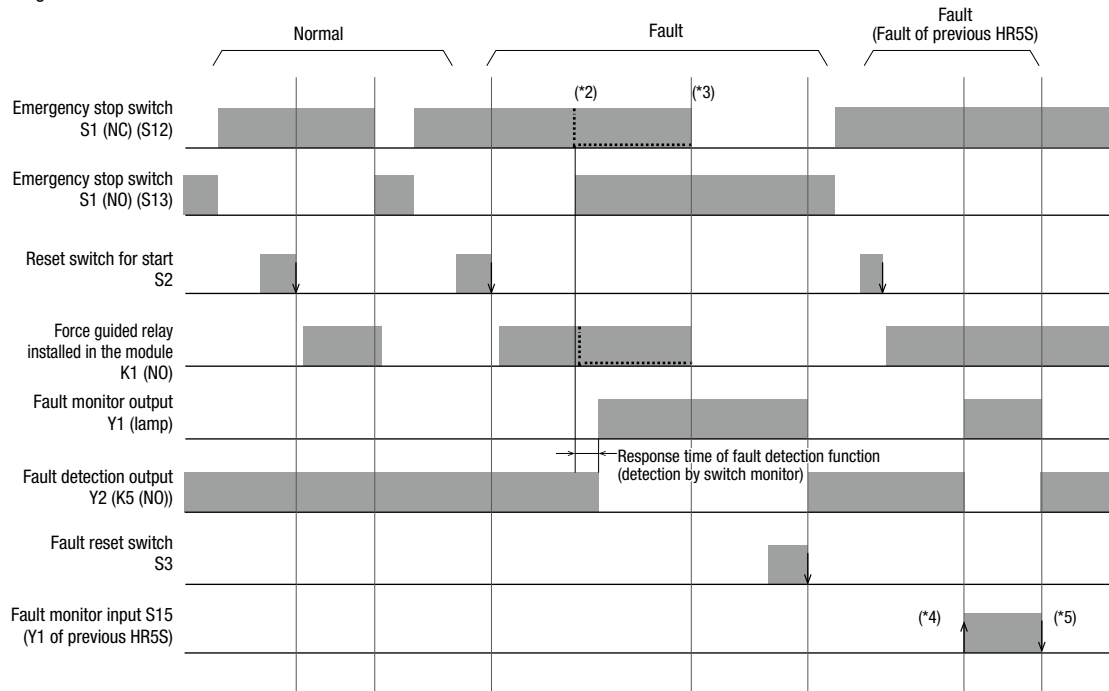

- \*2) Short-circuit fault occurred with the input wire
- \*3) Fault removed
- \*4) Fault occurred with the previous HR5S
- \*5) Fault removed from the previous HR5S

### Wiring Diagram (Typical application)

HR5S-C2D-T□□□

The maximum achievable PL is "d".  
 (In the figure below, the auto reset input (S35) is used.)

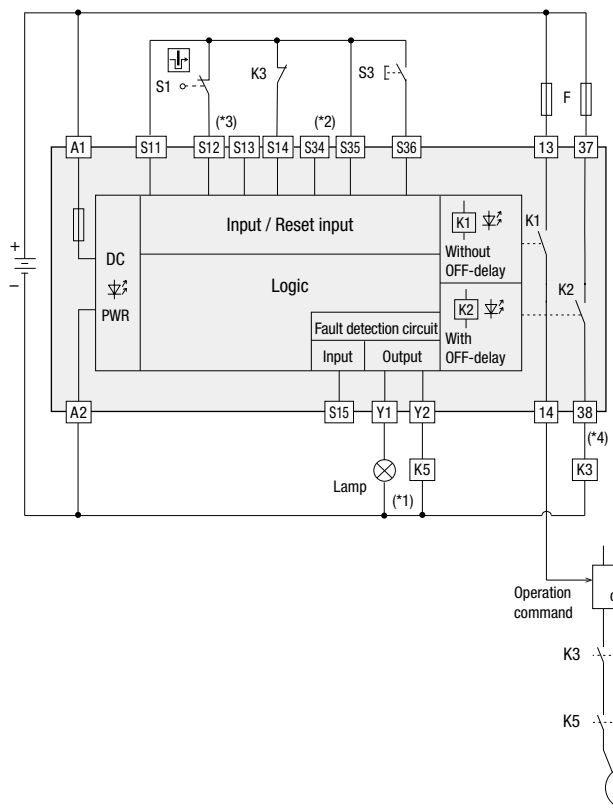

- S1 : Safety switch
- S3 : Reset switch for a fault
- K1, K2 : Force guided relay embedded in the module
- K3, K5 : Contactor
- M : Motor
- F : External fuse

- \*1) Regarding fault monitor output Y1 and fault detection output Y2  
 When PL is c, connect a warning lamp to Y1 (on during fault detection).  
 When PL is d, connect a contactor K5 to shut power of the hazardous source to Y2 (off during fault detection).
- \*2) When the auto reset input (S35) is used, it is necessary to do risk assessment to prevent an unexpected activation.
- \*3) When the switch monitor input (S13) is not used, it is necessary to exclude a short circuit between the cable of safety input (S12) and other cables (e.g. to protect the cables and/or to shield the cables).
- \*4) "Stop category 1" of IEC 60204-1 is corresponding to "SS1-t" of IEC 61800-5-2.

### Timing Chart

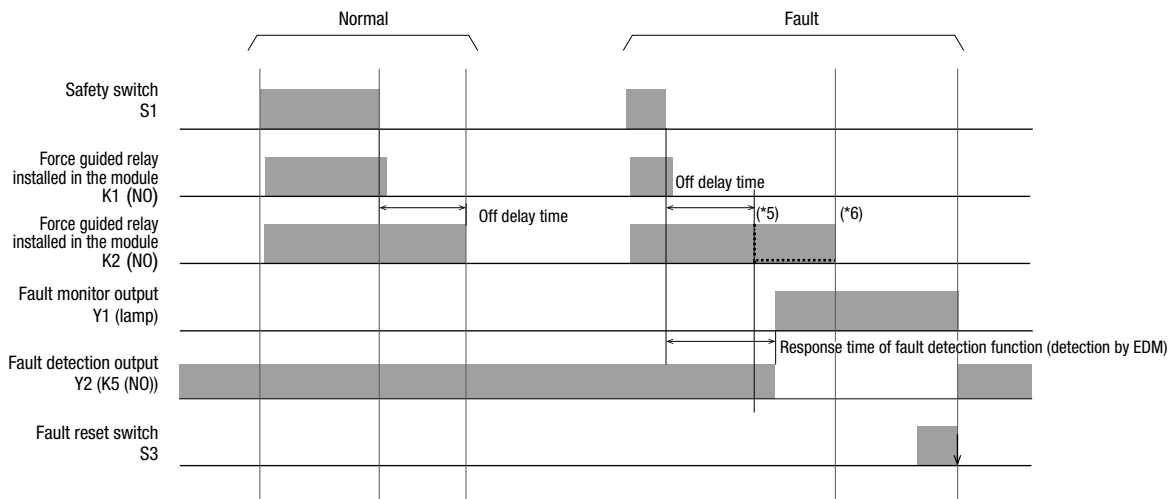

\*5) Welding fault occurred with contactor K2  
 \*6) Fault removed

Accessories

All dimensions in mm





Recommended Ferrules

When ordering, specify the Ordering No.

Name	Wire Size (Stranded Wire)		Part No.	Wire Strip Length	Package quantity
	AWG	mm <sup>2</sup>			
Ferrules with insulation cover 	24	0.25	S3TL-H025-12WJ	10 to 11mm	500
	22	0.34	S3TL-H034-12WT	10 to 11mm	
	20	0.50	S3TL-H05-14WA	10 to 11mm	
	18	0.75	S3TL-H075-14WW	10 to 11mm	

Tools

When ordering, specify the Ordering No.

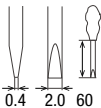
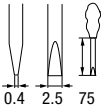
Name / Shape	Part No.	Package Quantity	Remarks
Crimping tool (for ferrules) 	S3TL-CR04T	1	Crimping shape: Trapezoidal 
Crimping tool (for ferrules) 	S3TL-CR06D	1	Crimping shape: Trapezoidal Indent 
Flat blade screwdriver 	S3TL-D04-20-60	1	Blade size (dimensions: mm) 
	S3TL-D04-25-75	1	Blade size (dimensions: mm) 

Safety Systems

- Operate, adjust, and maintain the product in accordance with the standards applicable to the equipment.
- Input and output equipment for safety control connected to this product should be compliant with ISO 13849-1 safety system requirements.
- The wiring examples shown in this catalog are examples only. Regarding the conformity of customer's safety system performance level, perform risk assessment and consult with a third-party certification organization.

 Safety Precautions

- Do not disassemble, repair, or modify the product. This may cause impairment of the safe operability of the safety relay module.
- Turn off the power to the product before starting installation, removing, wiring, maintenance, or inspection of the safety relay module. Failure to turn power off may cause electric shocks or fire hazard.
- Be sure to read the instructions attached to the product or website and use under the appropriate environment. Insufficient installation may lead to damage or failure.
- Make sure to take measures to prevent electric shock due to insulation damage between output 1 and output 2.
- Use within the specified voltage. Do not use a power supply that produce high ripple voltage or abnormal voltage.
- Use a power supply that meets following required specifications;
  - Complies with SELV or PELV circuit specified by IEC 60364-4-41.
  - Has the functionality of the control voltage and current of class 2 circuit, as defined in UL508.
- Check the safety function of the product periodically, turn OFF the signal to the safety input (e.g. at least once a year) and make sure the safety outputs turn OFF.
- The product is designed for installation within an enclosure. Do not install the product outside an enclosure. Install the product in an enclosure rated IP54 or higher.
- Install the product in environments described in this instruction sheet. If the safety relay module is used in places where the product is subjected to high temperature, high humidity, condensation, corrosive gases, excessive vibrations, and excessive shocks then electric shocks, fire hazard, or malfunction may result.
- Environment for using the product is "Pollution degree 2". Use the safety relay module under pollution degree 2 environment.
- When disposing the product, follow the laws and regulations of the country where it is disposed.
- Due to a power supply failure, the voltage of S11 (input driver) may rise to 34V DC maximum.

**Instructions**

See the instruction sheet for installation.

**Applicable Wire**

To wire the HR5S, use the following wires:

- Solid wire : 24 AWG to 16 AWG (0.2 to 1.5 mm<sup>2</sup>)
- Stranded wire / Flexible wire : 24 AWG to 18 AWG (0.25 to 0.75 mm<sup>2</sup>)
- Strip the cover of wire : 7 to 9 mm

Use cables conforming to applicable standards.

When using stranded wire, insulated ferrule should be used.

Use below insulated ferrule.

**Insulated ferrule (\*1)**

24 AWG to 18 AWG (0.25 to 0.75mm<sup>2</sup>)

**Connectable size**

- Crimp width a : 2.1 mm max.
- Height b : 1.48 mm max.
- Conductor length c : 7 to 9 mm

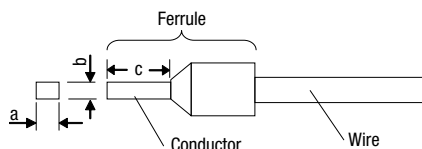

\*) When using a ferrule, refer to "Recommended Ferrules" below.  
When using a Crimping tool, refer to "Recommended Tools" below.

**Recommended Ferrules (Optional)**

Applicable Wire		Part No.
mm <sup>2</sup>	AWG	
0.25	24	S3TL-H025-12WJ
0.34	22	S3TL-H034-12WT
0.5	20	S3TL-H05-14WA
0.75	18	S3TL-H075-14WW

• See page 13 for details on recommended ferrules.

**Recommended Tools (Optional)**

Item	Part No.
Crimping tool	S3TL-CR06D
	S3TL-CR06D

• See page 13 for details on recommended ferrules.

Note 1) Note the crimping dimensions When using tools other than the recommended crimping tool. See "Connectable size" shown above for details.

Note 2) Use a tool recommended by the ferrule manufacturer.

**Inserting solid wire and insulated ferrule**

Insert the stripped solid wire or stranded wire with insulated ferrule in a straight direction. Tools are not required for wiring.  
After inserting, pull lightly to make sure wire is connected to the push-in terminal.

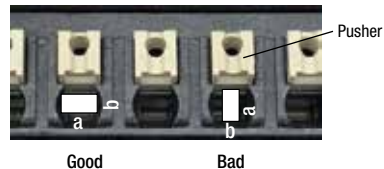

**Removing the wire**

Be sure to turn off the power before removing the wire.

- Push the pusher using a screwdriver, such as a flat screwdriver, with a force of approx. 20N.
- With the pusher pressed, pull the wire out in the straight direction.

**Recommended Tools (Optional)**

Name	Part No.
Flat screwdriver	S3TL-D04-20-60
	S3TL-D04-25-75

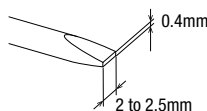

Be careful so that the push-in terminal is not damaged.

- Do not push the pusher by a force of more than 40N.
- Do not pull out the wire without pushing the pusher.

## Instructions

### Crimping of Ferrules and Wiring

- Choose an appropriate ferrule for the wire.
- Cut the wire carefully to get a flat end.
- Make sure that ferrule sleeve is completely filled by the conductor. Depending on the cross section, the conductor should protrude approx. 0 to 1 mm from the ferrule sleeve.

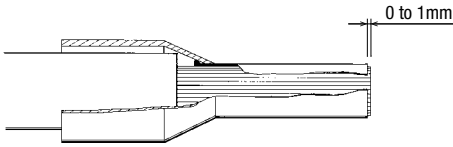

- When crimping, refer to the instructions of the crimping tool.

### Faults which can occur during crimping:

- Cracks along the sides and die impressions
- Splitting of the ferrules
- Asymmetrical crimping shape
- Extreme burrs formed along the sides
- Ferrule not filled by conductor
- Single conductors pushed back by protruding from the insulation cover
- Single conductors squeezed off
- Insulation cover damaged by the crimping jaw
- Conductor insulation not pushed into the insulation cover
- Ferrule bent longitudinally after crimping

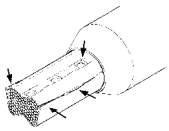

Formation of cracks at the sides.  
Sides split open

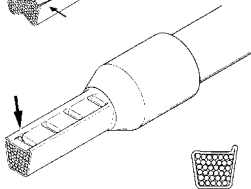

Formation of cracks at the  
impressions of the crimping jaw

Asymmetrical crimping shape.  
Burr formation on one side



Asymmetrical crimping shape.  
Burr formation on one side

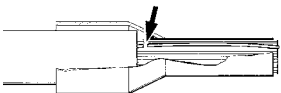

Single conductor squeezed off

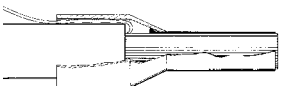

Single conductor pushed back

# Ordering Terms and Conditions

Thank you for using IDEC Products.

By purchasing products listed in our catalogs, datasheets, and the like (hereinafter referred to as "Catalogs") you agree to be bound by these terms and conditions. Please read and agree to the terms and conditions before placing your order.

## 1. Notes on contents of Catalogs

- (1) Rated values, performance values, and specification values of IDEC products listed in this Catalog are values acquired under respective conditions in independent testing, and do not guarantee values gained in combined conditions.  
Also, durability varies depending on the usage environment and usage conditions.
- (2) Reference data and reference values listed in Catalogs are for reference purposes only, and do not guarantee that the product will always operate appropriately in that range.
- (3) The specifications / appearance and accessories of IDEC products listed in Catalogs are subject to change or termination of sales without notice, for improvement or other reasons.
- (4) The content of Catalogs is subject to change without notice.

## 2. Note on applications

- (1) If using IDEC products in combination with other products, confirm the applicable laws / regulations and standards.  
Also, confirm that IDEC products are compatible with your systems, machines, devices, and the like by using under the actual conditions. IDEC shall bear no liability whatsoever regarding the compatibility with IDEC products.
- (2) The usage examples and application examples listed in Catalogs are for reference purposes only. Therefore, when introducing a product, confirm the performance and safety of the instruments, devices, and the like before use. Furthermore, regarding these examples, IDEC does not grant license to use IDEC products to you, and IDEC offers no warranties regarding the ownership of intellectual property rights or non-infringement upon the intellectual property rights of third parties.
- (3) When using IDEC products, be cautious when implementing the following.
  - i. Use of IDEC products with sufficient allowance for rating and performance
  - ii. Safety design, including redundant design and malfunction prevention design that prevents other danger and damage even in the event that an IDEC product fails
  - iii. Wiring and installation that ensures the IDEC product used in your system, machine, device, or the like can perform and function according to its specifications
- (4) Continuing to use an IDEC product even after the performance has deteriorated can result in abnormal heat, smoke, fires, and the like due to insulation deterioration or the like. Perform periodic maintenance for IDEC products and the systems, machines, devices, and the like in which they are used.
- (5) IDEC products are developed and manufactured as general-purpose products for general industrial products. They are not intended for use in the following applications, and in the event that you use an IDEC product for these applications, unless otherwise agreed upon between you and IDEC, IDEC shall provide no guarantees whatsoever regarding IDEC products.
  - i. Use in applications that require a high degree of safety, including nuclear power control equipment, transportation equipment (railroads / airplanes / ships / vehicles / vehicle instruments, etc.), equipment for use in outer space, elevating equipment, medical instruments, safety devices, or any other equipment, instruments, or the like that could endanger life or human health
  - ii. Use in applications that require a high degree of reliability, such as provision systems for gas / waterworks / electricity, etc., systems that operate continuously for 24 hours, and settlement systems
  - iii. Use in applications where the product may be handled or used deviating from the specifications or conditions / environment listed in the Catalogs, such as equipment used outdoors or applications in environments subject to chemical pollution or electromagnetic interference  
If you would like to use IDEC products in the above applications, be sure to consult with an IDEC sales representative.

## 3. Inspections

We ask that you implement inspections for IDEC products you purchase without delay, as well as thoroughly keep in mind management/maintenance regarding handling of the product before and during the inspection.

## 4. Warranty

- (1) Warranty period  
The warranty period for IDEC products shall be one (1) year after purchase or delivery to the specified location. However, this shall not apply in cases where there is a different specification in the Catalogs or there is another agreement in place between you and IDEC.
- (2) Warranty scope  
Should a failure occur in an IDEC product during the above warranty period for reasons attributable to IDEC, then IDEC shall replace or repair that product, free of charge, at the purchase location / delivery location of the product, or an IDEC service base. However, failures caused by the following reasons shall be deemed outside the scope of this warranty.
  - i. The product was handled or used deviating from the conditions / environment listed in the Catalogs
  - ii. The failure was caused by reasons other than an IDEC product
  - iii. Modification or repair was performed by a party other than IDEC
  - iv. The failure was caused by a software program of a party other than IDEC
  - v. The product was used outside of its original purpose
  - vi. Replacement of maintenance parts, installation of accessories, or the like was not performed properly in accordance with the user's manual and Catalogs
  - vii. The failure could not have been predicted with the scientific and technical standards at the time when the product was shipped from IDEC.
  - viii. The failure was due to other causes not attributable to IDEC (including cases of force majeure such as natural disasters and other disasters)Furthermore, the warranty described here refers to a warranty on the IDEC product as a unit, and damages induced by the failure of an IDEC product are excluded from this warranty.

## 5. Limitation of liability

The warranty listed in this Agreement is the full and complete warranty for IDEC products, and IDEC shall bear no liability whatsoever regarding special damages, indirect damages, incidental damages, or passive damages that occurred due to an IDEC product.

## 6. Service scope

The prices of IDEC products do not include the cost of services, such as dispatching technicians. Therefore, separate fees are required in the following cases.

- (1) Instructions for installation / adjustment and accompaniment at test operation (including creating application software and testing operation, etc.)
- (2) Maintenance inspections, adjustments, and repairs
- (3) Technical instructions and technical training
- (4) Product tests or inspections specified by you

The above content assumes transactions and usage within your region. Please consult with an IDEC sales representative regarding transactions and usage outside of your region. Also, IDEC provides no guarantees whatsoever regarding IDEC products sold outside your region.



# IDEC CORPORATION

**Head Office** 6-64, Nishi-Miyahara-2-Chome, Yodogawa-ku, Osaka 532-0004, Japan

 [www.idec.com](http://www.idec.com)

---

<b>USA</b>	IDEC Corporation	<b>Singapore</b>	IDEC Izumi Asia Pte. Ltd.	<b>China</b>	IDEC (Shanghai) Corporation	<b>Japan</b>	IDEC Corporation
<b>EMEA</b>	APEM SAS	<b>Thailand</b>	IDEC Asia (Thailand) Co., Ltd.		IDEC Izumi (H.K.) Co., Ltd.		
		<b>India</b>	IDEC Controls India Private Ltd.	<b>Taiwan</b>	IDEC Taiwan Corporation		

---

Specifications and other descriptions in this brochure are subject to change without notice.  
Information in this brochure is current as of October, 2024.  
2024 IDEC Corporation, All Rights Reserved.

EP1784-0

