

NEW



Actual size

New Low Profile Relays

Width 12.8 mm × Height 16.5 mm (*1)

RC Series

*1) Average size: RC2V



RC Series PCB Relays



SPDT: 12A (standard) 16A (high capacity)
DPDT: 8A contact ratings
 High capacity models suitable for industrial equipment control



Low profile
15.7mm (SPDT), 16.5mm (DPDT)
 Ideal for use on small equipment



Impulse withstand charge 10,000V
 High insulation resistance



Max. operating temperature 85°C (SPDT)
 For applications in high temperatures

RC series

Package quantity: 20

Contact configuration	Contact capacity	Part No.
SPST-NO	Standard	RC1V-A-*
SPDT		RC1V-C-*
SPST-NO	High capacity	RC1V-AH-*
SPDT		RC1V-CH-*
DPST-NO	Standard	RC2V-A-* (*2)
DPDT		RC2V-C-*

Specify the coil voltage in place of *.

- D5: 5V DC
- D12: 12V DC
- D24: 24V DC
- D48: 48V DC
- D110: 110V DC

*2) 110V DC types not available

Characteristics

Part No.	RC1V Standard	RC1V High capacity	RC2V Standard
No. of Poles	1-pole		2-pole
Contact configuration	SPST-NO, SPDT		DPST-NO, DPDT
Contact material	AgSnO ₂		Movable: AgSnO ₂ +Au-plated Stationary: AgSnO ₂
Degree of protection	Flux-resistant type (RTII)		
Contact resistance (*1)	100mΩ maximum		
Operating time (*2)	15ms maximum		
Release time (*2)	5ms maximum		
Insulation resistance	1000MΩ minimum (500V DC megger)		
Dielectric strength	Impulse withstand voltage	Between contact circuit and coil	10,000V
	Between contact circuit and coil	5000V AC, 1 minute	
	Between contacts of different poles		3000V AC, 1 minute
Vibration resistance	Between contacts of the same pole	1000V AC, 1 minute	
	Operating extremes	Frequency: 10 to 55Hz Amplitude: 0.35mm	Frequency: 10 to 55Hz, Amplitude 0.825mm
	Damage limits	Frequency: 10 to 55Hz Amplitude: 0.75mm	Frequency: 10 to 55Hz, Amplitude 1.65mm
Shock resistance	Operating extremes	100m/s ²	
	Damage limits	1000m/s ²	
Electrical life (rated load)	100,000 times min. (250V AC/24V DC, 12A)	RC1V-AH: 100,000 times min. (250V AC/24V DC, 16A) RC1V-CH: 5 million times min. (250V AC, 16 A) 3 million times min. (24V DC, 16A)	5 million times min. (250V AC/24V DC, 8A)
	(operation frequency 600 times/hour)		
Mechanical life (no load)	20 million times min. (operating frequency: 18,000 times per hour)		
Operating temperature	-40 to +85°C (no freezing)		
Operating humidity	5 to 85%RH (no condensation)		
Storage temperature	-40 to +85°C (no freezing)		
Operating humidity	5 to 85%RH (no condensation)		
Weight (approx.)	13g		12g

Note) Above values are initial values.

*1) Measured using 6V DC, 1A voltage drop method *2) Measured at the rated voltage (at 20°C), excluding contact bounce time.

Contact ratings

Type		Allowable contact power		Rated load		Allowable contact current	Allowable contact voltage	Minimum applicable load (Reference value) (*3)
		Resistive load		Voltage	Resistive load			
RC1V	Standard	3000VA AC 288W DC		250V AC 24V DC	12A 12A	12A	440V AC 300V DC	5V DC 100mA
	High capacity	4000VA AC 384W DC		250V AC 24V DC	16A 16A	16A		
RC2V	Standard	2000VA AC 192W DC		250V AC 24V DC	8A 8A	8A	400V AC 300V DC	5V DC 10mA

*3) Minimum switching loads mentioned above are reference values. Reference values may vary according to switching frequencies, environmental conditions and expected reliability levels. Perform the confirmation test with the actual load before use.

• When the maximum current flow exceeds 10A, take into consideration the heat generated by the PCB wiring. Check the operation using the actual load.

Coil ratings

Type	Coil rated voltage	Code □	Rated current (mA) ±10% (at 20°C)	Coil resistance (Ω) ±10% (at 20°C)	Operating characteristics (against rated values at 20°C)			Power consumption (approx.)
					Maximum allowable voltage (*1)	Minimum pickup voltage (initial value)	Dropout voltage (initial value)	
RC1V	5V DC	D5	81	62	12.3V	70% maximum	10% minimum	400mW
	12V DC	D12	33	360	29.4V			430mW
	24V DC	D24	17	1440	58.8V			420mW
	48V DC	D48	9	5360	117.6V			
RC2V-A	110V DC	D110	4	28,800	269.5V			
	5V DC	D5	81	62	9.87V	75% maximum	10% minimum	400mW
	12V DC	D12	33	360	23.7V			
	24V DC	D24	17	1440	47.4V			
48V DC	D48	9	5760	94.8V				
RC2V-C	110V DC	D110	—	—	—			
	5V DC	D5	106	47	8.7V	70% maximum	10% minimum	530mW
	12V DC	D12	44	270	21.0V			
	24V DC	D24	22	1100	42.0V			
48V DC	D48	11	4400	84.0V				
	110V DC	D110	5	22,000	192.5V			550mW

*1) The maximum allowable voltage is the maximum value of voltage that can be applied to the relay coil and not the continuous allowable value.

Dimensions

Note: Terminal dimensions are dimensions before pre-soldering.

All dimensions in mm.

RC1V-A-D

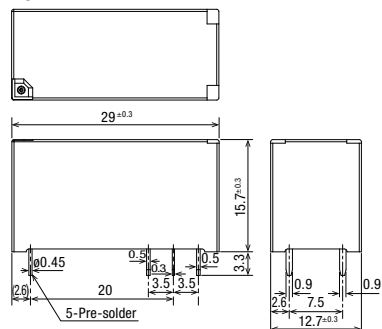

RC1V-C-D

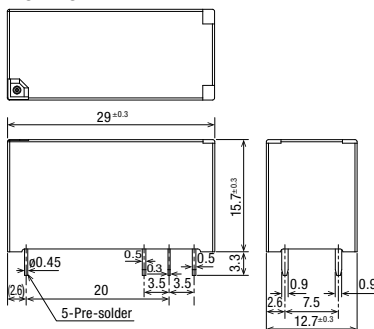

RC1V-AH-D

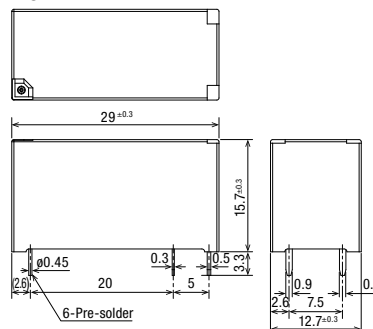

RC1V-CH-D

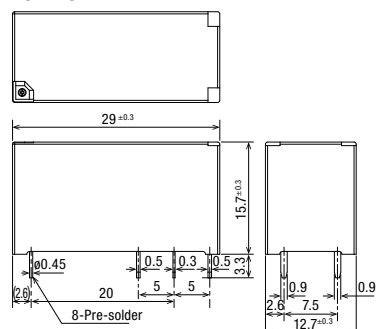

RC2V-A-D

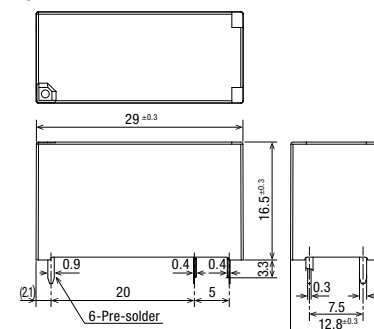

RC2V-C-D

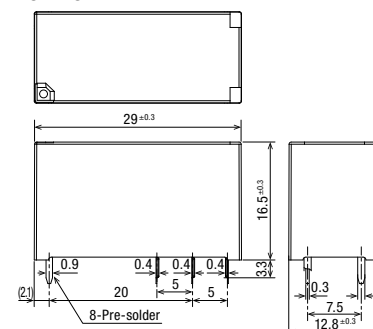

PCB drilling layout (Bottom View)

RC1V-A-D

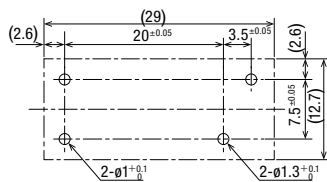

RC1V-C-D

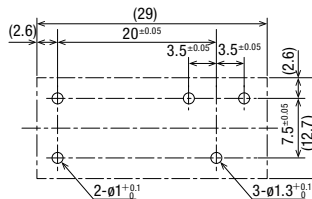

RC1V-AH-D

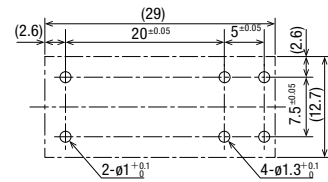

RC1V-CH-D

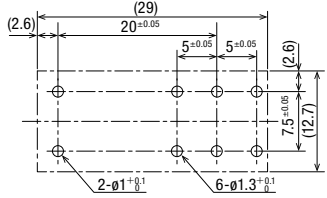

RC2V-A-D

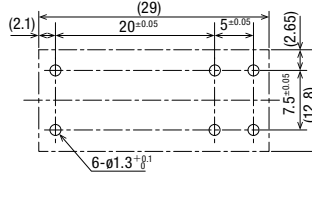

RC2V-C-D

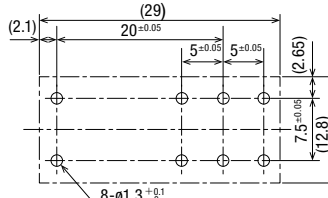

Internal connection (Bottom view)

RC1V-A-D

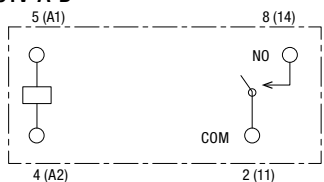

RC1V-C-D

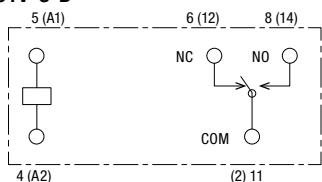

RC1V-AH-D (*1)

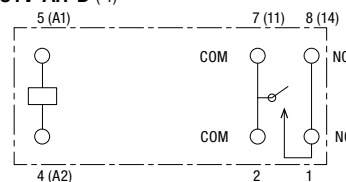

RC1V-CH-D (*1)

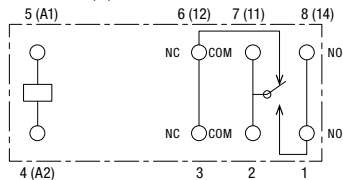

RC2V-A-D

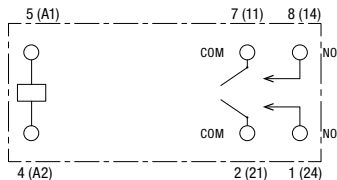

RC2V-C-D

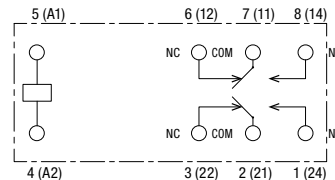

Note) IEC notation in ().

*1) Both #1 and #8 should be used and the pattern should be designed to short-circuit on the board.

Characteristics (Reference)

Coil temperature rise

RC1V (standard)

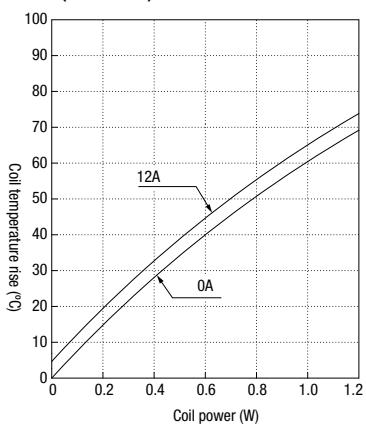

RC1V (high capacity)

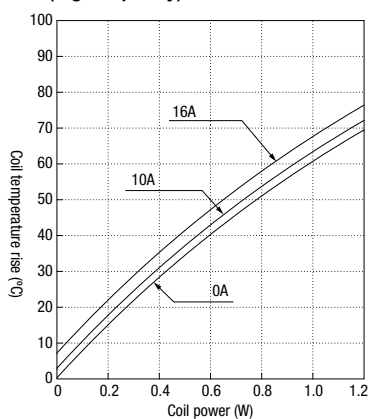

RC2V (standard)

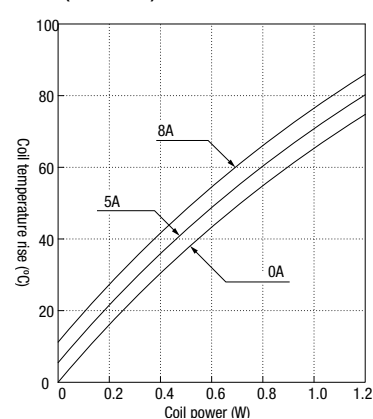

Operating range

RC1V (standard)

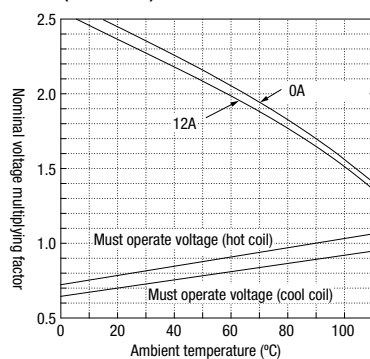

RC1V (high capacity)

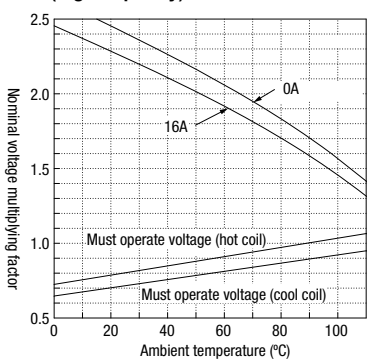

RC2V (standard)

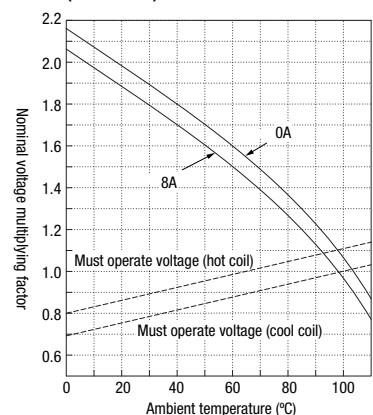

Electric life curves

RC1V (standard)

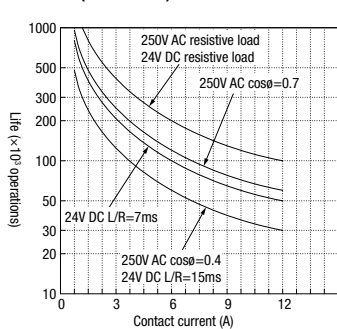

RC1V-AH (high capacity)

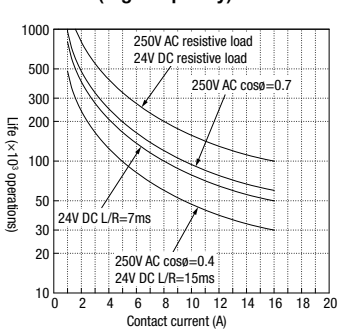

RC1V-CH (high capacity)

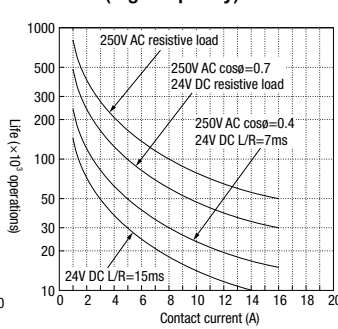

RC2V (standard)

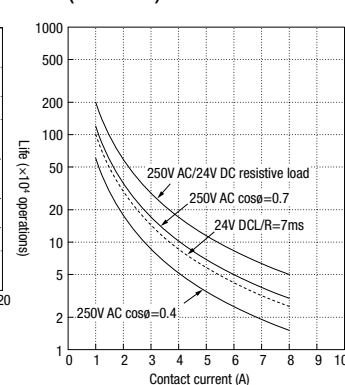

Characteristics (Reference)

Maximum operating frequency

RC1V (standard)

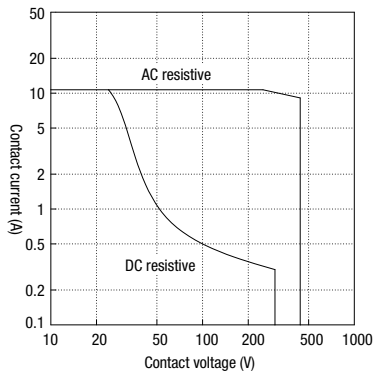

RC1V (high capacity)

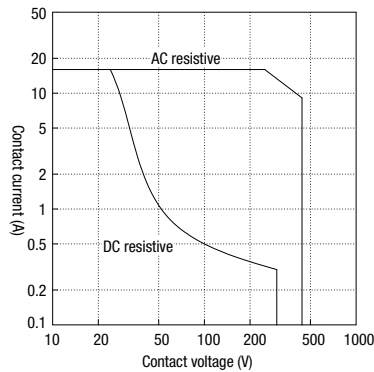

RC2V (standard)

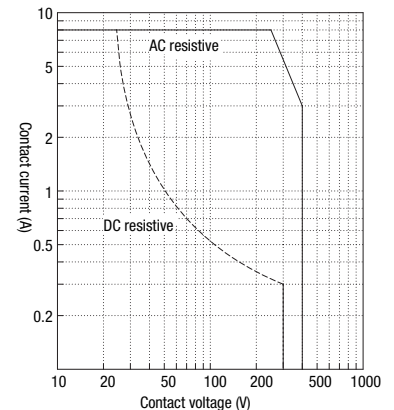

Instructions

- Do not subject the relay to vibrations or shocks exceeding the rated values (vibration resistance and shock resistance). Abnormal vibration or shock may cause not only malfunction but also deformation or damage to the internal parts of the relay, which may result in malfunction.
- Be sure to apply a square wave rated voltage to the coil. For other uses, confirm the operation characteristics with the actual device before use.
- Avoid using the product in an atmosphere where silicone gas, sulfide gas, or organic gas exists. Also, note that the use of silicone resin around the relay may cause contact failure.
- When using in low temperatures below 0°C, be careful of freezing. Freezing may cause adhering of moving parts, delay in operation, or ice between contacts, which may interfere with contact continuity.
- When multiple relays are closely mounted on the same board, magnetic interference between relays and heat generation may affect the relay characteristics. Confirm that the individual relays operate under the operating conditions of the surrounding relays before use.
- Precautions when mounting on PCB
 - Hand soldering should be done quickly at 360°C within 3 seconds.
 - Auto-soldering: Pre-heat at below 120°C within 90 seconds. Solder at 255°C±5°C within 5 seconds.
 - Because the terminal part is filled with epoxy resin, do not excessively solder or bend the terminal. Otherwise, air tightness will degrade.
 - Avoid the soldering iron from touching the relay cover or the epoxy filled terminal part.
 - Use a non-corrosive rosin flux.

Operation humidity range

RC1V

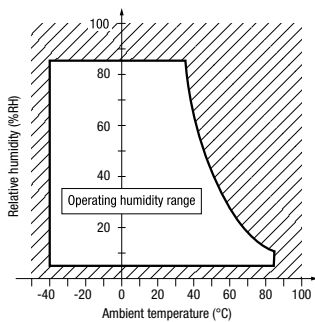

RC2V

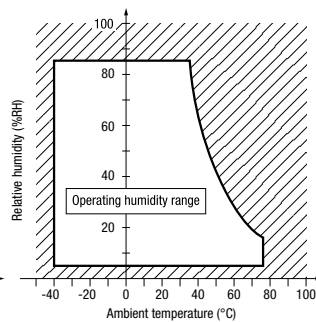

Storage humidity range

RC1V

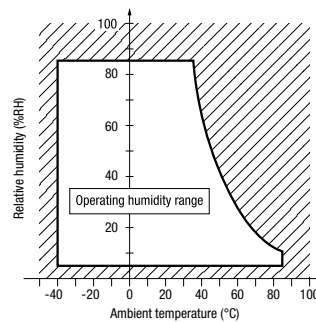

RC2V

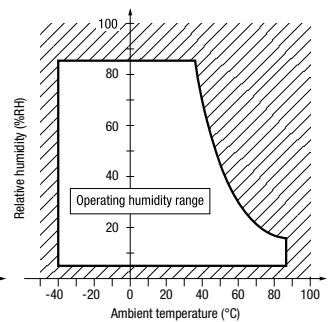

IDEC CORPORATION

Head Office 6-64, Nishi-Miyahara-2-Chome, Yodogawa-ku, Osaka 532-0004, Japan

USA IDEC Corporation
EMEA APEM SAS

Singapore IDEC Izumi Asia Pte. Ltd.
Thailand IDEC Asia (Thailand) Co., Ltd.
India IDEC Controls India Private Ltd.

China IDEC (Shanghai) Corporation
IDEC Izumi (H.K.) Co., Ltd.
Taiwan IDEC Taiwan Corporation

Japan IDEC Corporation

 www.idec.com

Specifications and other descriptions in this brochure are subject to change without notice.
Information in this brochure is current as of July, 2023.
2023 IDEC Corporation, All Rights Reserved.

EF1164-1

