





# MICRO/I<sup>TM</sup>

HG1J

Instruction Manual

## SAFETY PRECAUTIONS

- Be certain to read this manual carefully before performing installation, wiring, or maintenance work, or operating the MICRO/I HG1J. If the MICRO/I is used in a manner not specified by the manufacturer, the protection provided by the equipment may be impaired.
- The MICRO/I has been manufactured with careful regard to quality. However, if you intend to use this product in applications where failure of this equipment may result in damage to property or injury, ensure that it is used in conjunction with appropriate fail-safe backup equipment.
- Precautionary measure should be taken to avoid unauthorized access from the outside network to the MICRO/I. Please note that the Company shall not be liable for any loss, damage or other expenses incurred directly or indirectly by unauthorized access, etc.
- In this manual, safety precautions are categorized depending on the severity as Warning or Caution:

|  |  |
|--|--|
|  <b>WARNING</b> | Warning notices are used to emphasize that improper operation may cause severe personal injury or death. |
|  <b>CAUTION</b> | Caution notices are used where inattention might cause personal injury or damage to equipment.           |

### WARNING

- This product is not designed for use in applications requiring a high degree of reliability and safety, such as applications for medical devices, nuclear power, railroads, aerospace, and automotive devices. This product should not be used for such applications.
- Turn off the power of this product before installation, removal, wiring, maintenance, and inspection of this product. Failure to turn power off may cause electrical shock or fire hazard.
- Special expertise is required to install, wire, configure, and operate this product. Person without such expertise must not use this product.
- This product uses an LCD (liquid crystal display) as a display device. The liquid inside the LCD is harmful to the skin. If the LCD is broken and the liquid attaches to your skin or clothing, wash the liquid off using soap, and consult a doctor immediately.
- An emergency circuit that uses emergency stop switch must be configured outside of this product.
- Do not use touch switches, the function keys and selector switches for an emergency circuit or an interlocking circuit. If this product fails, equipment connected to this product will no longer be protected, and serious injury to operators and equipment damage may be caused.
- In case this product is accidentally dropped or exposed to significant shock, stop using this product, check this product for damage, and confirm that its various functions work safely and correctly.
- Connect MICRO/I's FG wire to grounding resistance of 100 Ω or less. Otherwise, there is a risk of electric shock or malfunction.
- The screen will not be visible if the backlight of this product burns out. However, the touch panel and the function keys will remain functional. Thus, Erroneous touch panel operation or function key operation may occur while controlling the touch panel. Because such erroneous operations could result in damage, the touch panel and the function key should not be used once the backlight is burned out.

 **CAUTION**

- Prevent this product from falling while moving or transporting, otherwise it may cause damage or malfunction to this product as a result.
- Use the product within the environmental limits given in the catalog and this manual. Use of the product in high-temperature or high-humidity environments, or in locations where it is exposed to condensation, corrosive gas, or large shock loads can create the risk of electrocution and fire.
- This product is designed for use in pollution degree 2. Use this product in environments of pollution degree 2. (based on the IEC 60664-1 rating)
- Install this product according to this manual. Improper installation will result in falling, failure, electrical shock, fire hazard, or malfunction of this product.
- Prevent metal fragments or wire chips from dropping inside this product housing. Ingress of such fragments and chips may cause fire hazard, damage, and malfunction.
- Use a power supply of the rated value. Using a wrong power supply may cause fire hazard.
- When exporting this product to Europe, use an EN 60127 (IEC 60127) approved fuse on the power line outside this product.
- When exporting this product to Europe, use an EU-approved circuit protector.
- Make sure of safety before starting and stopping this product. Incorrect operation of this product may cause mechanical damage or accidents.
- This product cannot be directly connected to the communication lines (including public wireless LAN) of telecommunication carriers (mobile communication companies, fixed-line communication companies, Internet providers, etc.). When connecting this product to the Internet, be sure to connect via a device, such as a router.
- The touch panel of this product is made of glass, and will break if exposed to excessive shock. Take due care when handling it.
- The protective film attached to the display of this product is to protect the product from scratches during transportation. Please remove the protective film before use. If the display is used with protective film, the film may become cloudy and stick to the display depending on the usage environment and may become unremovable.
- Do not push hard or scratch the touch panel and protection sheet with a hard object like hand tool. Touch panel and protection sheet can be easily damaged.
- Do not install this product in areas subjected to strong ultraviolet rays, since ultraviolet rays may impair the quality of the LCD.
- Do not attempt to disassemble, repair or modify this product. This can create the risk of fire or electrocution.
- When disposing of this product, do so as an industrial waste.
- When using this product in a system that requires clock accuracy, set the time regularly.
- Do not switch off the power or pull out the SD Memory Card or the USB flash drive while it is being accessed, as this may result in destruction of the stored data. If the data on the SD Memory Card or the USB flash drive is corrupted, format the SD Memory Card or the USB flash drive.
- Turn off the power supply of this product before connecting or disconnecting USB devices other than USB memory.
- This product uses "PS2" as DC power supply. (based on the IEC/EN 61131 rating)
- Use wire of a proper size to meet the voltage and current requirements.
- When operating the touch panel in an environment where the ambient operating temperature exceeds 50°C, there is a risk of getting burn injury. So please use heat-resistant gloves, touch pen, and such to prevent burn injury.

## Revision history

July 2024: First Edition

## Caution

- All rights in this manual belong to IDEC Corporation. It may not be reproduced, reprinted, sold, transferred or rented without our permission.
- The contents of this manual are subject to change without notice.
- Please contact your vendor or IDEC Corporation with any problems regarding the operation of this product.

## Trademarks

WindO/I and MICRO/I are registered trademarks of IDEC CORPORATION in JAPAN.

All other company names and product names used in this manual are trademarks of their respective owners.

## Regarding Compatible Standards

The conforming standards supported by the HG1J are as follows.

### UL 121201 / CSA C22.2 No.213 (Under application)

- This product is for indoor use only.
- Open type or panel mounted when installed in a Listed Type 4X "Indoor Use Only", Type 13 enclosure.
- The use of an SELV source.
- When wiring this product at the field, use copper conductors only.

| Test item particulars             |   |
|-----------------------------------|---|
| Type of item                      | Open Type/enclosed type when panel mounted in appropriate end enclosure |
| Description of equipment function | Control   |
| Connection to mains supply        | N/A connected to SELV source  |
| Overvoltage Category              | None  |
| Pollution Degree                  | 2   |
| Environmental Conditions          | Extended:   |
| Temperature:                      | -20 to +55°C, see RATINGS section for detail.                           |
| Humidity:                         | 10 to 95%RH (no condensation)   |
| For use in wet locations          | NO  |
| Equipment mobility                | Panel mounted   |
| Operating Conditions              | Continuous  |

- This product is suitable for use in Class I, Division 2, Groups A, B, C, D or Non-Hazardous locations only.
- RATINGS:  
Input: 24 Vde, 12W, SELV, LIM  
Maximum Surrounding Air: -20 to +55°C  
Enclosure Type 4X Indoor Use only, Type 13
- Temperature Code: T4A
- Equipment to be installed in an environmentally suitable enclosure that requires the use of a tool to access.
- L'appareil HG1J est conçu pour être utilisé uniquement dans des emplacements de classe I, division 2, groupes A, B, C, Dou non dangereux.
- Caracteristiques:  
Entree: 24 Vde, 12W, Tres basse tension de securite (SELV), LIMITES Air ambiant maximal: -20 a +55°C  
Boitiers de type 4X pour une utilisation interieure, de type 13.
- Code de temperature: T4A
- L'appareil HG1J doit être installé dans un boîtier adapté à l'environnement et uniquement accessible à l'aide d'outils.

## Preface

Thank you for purchasing the MICRO/I manufactured by IDEC Corporation.

This manual describes the specifications of MICRO/I HG1J how to install it, and various functions.

Read this manual to ensure the correct understanding of the entire functions of this product.

IDEC Corporation makes the latest product manual PDFs available on our website at no additional cost. Please download the latest product manual PDFs from our website.

Read the following materials as necessary for your particular application.

| References                                      | Content   |
|---|---|
| MICRO/I HG1J Instruction Manual (This document) | Describes the product specifications, installation and wiring methods, maintenance and inspection of the HG1J.  |
| MICRO/I Hardware Manual (PDF)                   | Describes the product specifications, installation and wiring instructions of the HG2J/1J, HG5G/4G/3G/2G-V, HG4G/3G, HG2G-5F/-5T and HG1G/1P, optional items, and expansion modules.                              |
| WindO/I-NV4 User's Manual (PDF)                 | Describes the basic operations of the HG2J/1J, HG5G/4G/3G/2G-V, HG4G/3G, HG2G-5F/-5T and HG1G/1P, how to create the project necessary for operation, and the various drawings and parts that make up the project. |
| WindO/I-NV4 External Device Setup Manual (PDF)  | Describes the connection procedures and available device addresses for various communication including the Device Link Communication, O/I Link communication, and DM Link communication.                          |

## Symbols Used in this Manual

This manual uses the following symbols to facilitate explanation.

### Symbols



..... Information that requires special attention. Failure to operate the product in accordance with the information provided can lead to serious injury or damage.



..... Information relating to requests or material to reference in the use of a function



..... Useful information relating to a function

**OK**

..... Screen buttons are indicated by **bold** text or by using the actual graphic icon.

**\*\*\*\***

..... Controls are indicated by bold text.

## Abbreviations, Generic Terms, and Terminology Used in this Manual

| Item               | Description  |
|--------------------|--|
| HG1J               | The name is short for MICRO/I HG1J-4FT22TG-*.  |
| External Device    | Generic term used to refer to a PLC or micro computer that is connected to and communicates with the main unit.  |
| Device Address     | Memory that is capable of storing values in unit of bits or words loaded on the main unit and external device.   |
| User Communication | A communication method which performs communication with external devices such as barcode readers and inverters. |
| WindO/I-NV4        | Integrated configuration software application for creating projects of the main unit.                            |
| Operating System   | Software used to manage and control system software.   |
| System Software    | Software that performs basic control and management of the main unit.  |
| Project            | Data including image data required for operating the main unit, which is created with WindO/I-NV4.               |
| Setup              | Generic term used to refer to the common settings in the project.  |
| Script             | A function that can describe complex calculations and operations in text.  |
| Internal Device    | The generic term for internal device addressing on the main unit such as internal relays, registers, etc.        |
| Parts              | Define as functional content (i.e. button, pilot lamp, commands, etc.)   |

## Contents

|   |           |
|---|-----------|
| SAFETY PRECAUTIONS .....  | Preface-1 |
| Revision history .....  | Preface-3 |
| Caution .....   | Preface-3 |
| Trademarks.....   | Preface-3 |
| Regarding Compatible Standards .....                                    | Preface-4 |
| Preface .....   | Preface-5 |
| Symbols Used in this Manual .....                                       | Preface-5 |
| Abbreviations, Generic Terms, and Terminology Used in this Manual ..... | Preface-6 |

## Chapter 1 Main Unit Specifications

---



|   |   |      |
|---|---|------|
| 1 | HG1J .....                              | 1-1  |
|   | 1.1 Packing Content .....               | 1-1  |
|   | 1.2 Type Number .....                   | 1-1  |
|   | 1.3 Part Names.....                     | 1-2  |
|   | 1.4 External Interfaces .....           | 1-3  |
|   | 1.5 Specifications .....                | 1-5  |
|   | 1.6 Dimensions.....                     | 1-8  |
|   | 1.7 Installation .....                  | 1-9  |
|   | 1.8 Wiring .....                        | 1-12 |
|   | 1.9 Maintenance and Inspection.....     | 1-14 |
|   | 1.10 Software License Information ..... | 1-15 |



## 1 HG1J

### 1.1 Packing Content

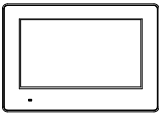
Before installing the HG1J, make sure that the model you have received is what you actually ordered, and no parts are damaged to accidents during shipping.

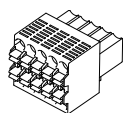
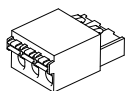
| Product Name & Appearance  | Quantity | Description                     |
|--|----------|---------------------------------|
| HG1J<br>                              | 1        | Main unit                       |
| Mounting clip<br>                     | 2        | -                               |
| Serial interface connector<br>        | 1        | Removable terminal block 10-pin |
| Power supply terminal connector<br> | 1        | Removable terminal block 3-pin  |

### 1.2 Type Number

| LCD                     | Bezel Color | Type Number    |
|-------------------------|-------------|----------------|
| 4.3 inch wide TFT Color | Black       | HG1J-4FT22TG-B |
|                         | Silver      | HG1J-4FT22TG-S |

### 1.3 Part Names

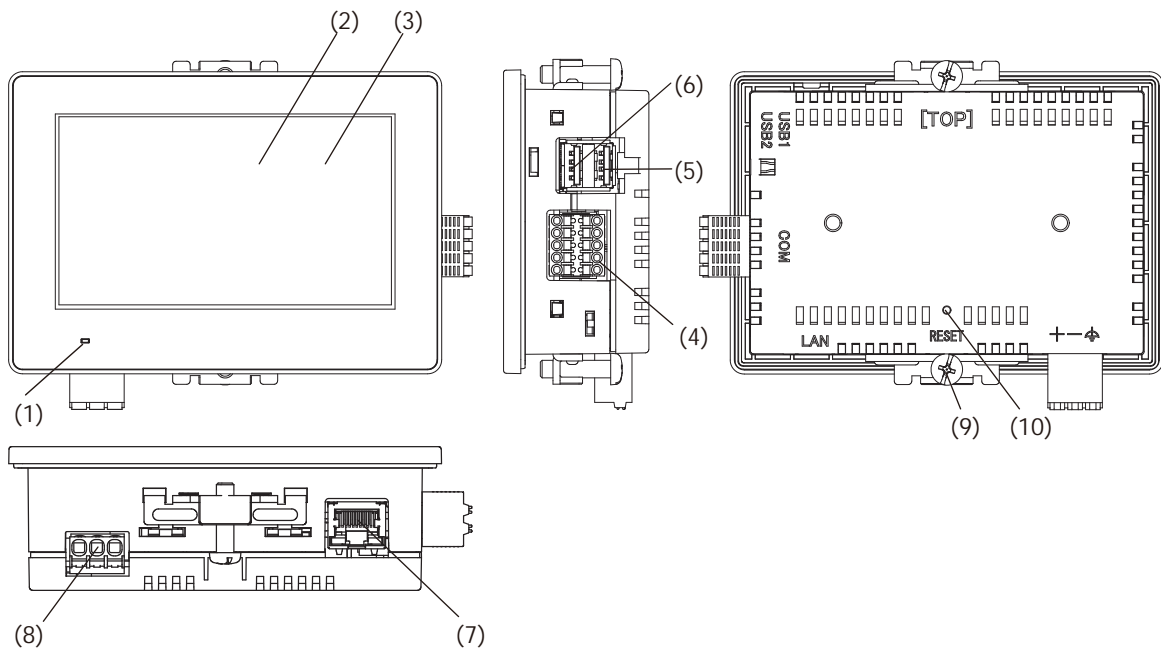

| No.  | Name                     | Description   |
|------|--------------------------|---|
| (1)  | POWER LED                | Green (lit): Normal Operation<br>Green (flash): Operating system is booting. (Normal Operation)<br>Orange (lit): Operating system is booting. (Boot mode)<br>Orange (flash): Preparing to boot the operating system, running in boot mode.<br>Red (lit): Main unit is damaged.<br>Not lit : Power is off. |
| (2)  | Display                  | TFT color LCD   |
| (3)  | Touch Panel              | PCAP touchscreen (Projected capacitive)   |
| (4)  | Serial Interface (COM)   | RS232C, RS422/485<br>Connector: Terminal Block 10-pin (Push-in type)<br>Maximum cable length: 15m (RS232C), 1200m (RS422/485)   |
| (5)  | USB Interface (USB1)     | USB2.0 (Host)<br>Connector: Type-A<br>Output current: 5V 500mA  |
| (6)  | USB Interface (USB2)     | USB2.0 (Host)<br>Connector: Type-A<br>Output current: 5V 500mA  |
| (7)  | Ethernet Interface (LAN) | IEEE802.3u 10BASE-T/100BASE-TX<br>Connector: RJ-45(With Auto MDI/MDI-X function)<br>Cable: CAT or higher, STP<br>Maximum cable length: 100m   |
| (8)  | Power Supply Terminal    | Connector (Main unit's accessories): Removable terminal block 3-pin (Push-in type)  |
| (9)  | Mounting Clip Position   | 2 places  |
| (10) | RESET Switch             | Tact switch   |

## 1.4 External Interfaces

### ⚠ CAUTION

- Make sure to turn off the power to the HG1J before wiring each interface.
- The serial interface (COM) can be used as the RS232C and RS422/485 interfaces at same time.
- Use the SELV (Safety Extra-Low Voltage) circuit to connect each interface.

#### ● Serial Interface (COM)

Use applicable cables for wiring and recommended ferrules (made by IDEC, Weidmüller or Phoenix Contact) as follows.

|                         |   |   |  |
|-------------------------|---|---|--|
| Interface Specification | RS232C, RS422/485   |   |  |
| Connector               | Detachable Terminal Block 10-pin  |   |  |
| Applicable cable        | AWG16 to 28   |   |  |
| Conductor Type          | Solid wire or Stranded wire   |   |  |
| Wire Strip Length *1    | 8 to 9 mm   |   |  |
| Recommended ferrule     | ST3L-H025-12WJ<br>S3TL-H034-12WT<br>S3TL-H05-14WA<br>S3TL-H075-14WW<br>(IDEC) | H0,25/12 HBL<br>H0,34/12 TK<br>H0,5/14 OR<br>H0,75/14 W<br>(Weidmüller) | AI 0,25-8YE<br>AI 0,34-8TQ<br>AI 0,5-8WH<br>AI 0,75-8GY<br>(Phoenix Contact) |

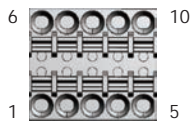

| No. | Name | I/O | Function         | Communication type |
|-----|------|-----|------------------|--------------------|
| 1   | SD   | OUT | Send Data        | RS232C             |
| 2   | RD   | IN  | Receive Data     |                    |
| 3   | RS   | OUT | Request to Send  |                    |
| 4   | CS   | IN  | Clear to Send    |                    |
| 5   | SG   | -   | Signal Ground    |                    |
| 6   | SDA  | OUT | Send Data (+)    | RS422/485          |
| 7   | SDB  | OUT | Send Data (-)    |                    |
| 8   | RDA  | IN  | Receive Data (+) |                    |
| 9   | RDB  | IN  | Receive Data (-) |                    |
| 10  | SG   | -   | Signal Ground    |                    |



Only one ferrule can be inserted into a terminal hole.

Please set another terminal block in the vicinity of the main unit and connect SG when using RS232C and RS422/485 requiring crossover wiring at the same time. And separate the communication cables so that they do not affect each communication waveform when using RS232C and RS422/485 at the same time.

\*1 Strip the sheath of the wire 8 to 9 mm from the end.

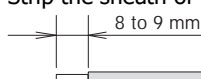

### Using RS422/485 interface

HG1J is not equipped with terminating resistor. Insert a terminating resistor of an appropriate value (about 100 to 120 Ohm, 1/2 W minimum) between terminal number 8 (RDA) and terminal number 9 (RDB), if necessary.

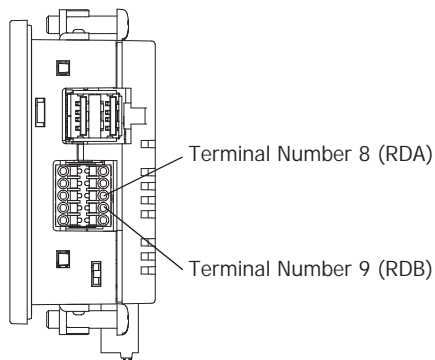

For details about inserting and removing wires, refer to "1.8 Wiring" on page 1-12.

## 1.5 Specifications

### ■ Applicable Standards

|                  |   |
|------------------|---|
| Safety Standards | UL61010-1, UL61010-2-201, UL121201<br>CSA C22.2 No.61010-1-12 (c-UL), CSA C22.2 No.61010-2-201 (c-UL),<br>CSA C22.2 No.213 (c-UL) |
| EMC Standards    | IEC/EN 61131-2  |

### ■ Environmental Specifications

|                               |  |
|-------------------------------|--|
| Ambient Operating Temperature | -20 to +55°C*1 (no freezing)   |
| Ambient Operating Humidity    | 10 to 95% RH (no condensation)   |
| Ambient Storage Temperature   | -20 to +70°C (no freezing)   |
| Ambient Storage Humidity      | 10 to 95% RH (no condensation)   |
| Altitude                      | 0 to 2,000 m (1,013 to 795hPa) during operation<br>0 to 3,000 m (1,013 to 701hPa) during transport |
| Pollution Degree              | 2  |
| Corrosion Immunity            | Free from corrosive gases  |

### ■ Electrical Specifications

|  |   |
|--|---|
| Rated Voltage                          | 12V/24V DC  |
| Power Consumption                      | 12W maximum   |
| Not using USB Interface (USB1, USB2)   | 4W maximum  |
| Backlight OFF                          | 3W maximum  |
| Power Voltage Range                    | 10.2 to 28.8V DC  |
| Allowable Momentary Power Interruption | 10 ms maximum (Power supply: 20.4 to 28.8V DC)<br>1 ms maximum (Power supply: 10.2 to 20.4V DC) |
| Inrush Current                         | 40A maximum   |
| Dielectric Withstand Voltage           | AC500V, 10mA, 1 minute (between power and earth terminals)                                      |

### ■ Construction Specifications

|                      |  |
|----------------------|--|
| Vibration Resistance | 5 to 8.4Hz amplitude 3.5mm,<br>8.4 to 150Hz acceleration 9.8m/s <sup>2</sup><br>10 times on each of three mutually perpendicular axes<br>(IEC 61131-2) |
| Shock Resistance     | 147m/s <sup>2</sup> , 11ms (3 shocks on each of three mutually perpendicular axes)<br>(IEC 61131-2)  |

\*1 For details about the output current limitation of the USB interface due to the ambient operating temperature, refer to "Restrictions due to mounting orientation" on page 1-11.

## ■ Performance Specifications

|  |                                    |  |
|--|------------------------------------|--|
| Display  | LCD Type <sup>*1</sup>             | TFT color LCD  |
|  | Display Colors                     | 16.77 M  |
|  | Effective Display Area             | 95.04 (W) × 53.856 (H) mm  |
|  | Display Resolution                 | 480 (W) × 272 (H) dots   |
|  | Dot pitch                          | 0.198 (W) × 0.198 (H) mm   |
|  | View angle                         | Left/Right/Top/Bottom: 80°   |
|  | Brightness of LCD only             | 500 cd/m <sup>2</sup>  |
|  | Brightness Adjustment              | 32 levels  |
|  | Backlight                          | LED (white)  |
|  | Backlight Life <sup>*2</sup>       | Approx. 50,000 hours (The time until brightness becomes 50% of the initial value)  |
| Touch Panel  | Switch Type                        | Projected Capacitive   |
|  | Multiple Operations                | Possible (2-point touch)   |
| User Memory  |                                    | Approx. 24 MB  |
| Backup time of the real-time clock (Ambient Operating Temperature at 25°C) |                                    | Typ. 20 days <sup>*4</sup>   |
| Backup Data  | Keep by a large-capacity capacitor | Clock Data   |
|  | Save to non-volatile memory        | Log data, HMI Keep Relays, HMI Keep Registers  |
| Buzzer output  |                                    | Single tone (tone length is adjustable)  |
| Degree of Protection <sup>*3</sup>   |                                    | Panel thickness is 1 mm or more and less than 1.6 mm: IP65F IEC 60529)<br>Panel thickness is 1.6 mm or more and 5 mm or less: IP66F, IP67F (IEC 60529), TYPE 4X (indoor use only), TYPE 13 |
| Weight (approx.)   |                                    | 260g   |

\*1 Please be aware that small black and bright dots might show up on LCD Screen: it is not a failure or malfunction.

\*2 The life of the LCD itself at an ambient temperature of 25°C. This is not a guaranteed value. The actual life depends on the environment and conditions of use.

\*3 It is a protection structure for the operating surface of HMI, which is attached to a panel. Although protection structure suffices every test conditions, it does not guarantee to operate under all of the environmental condition. As for IP65F/IP66F/IP67F oilproof structure, it suffices oilproof test conditions. Conditions are listed in the document that comes with Japanese Industrial Standard JIS C 0920. Protection structure do not guarantee usage under long exposure to oil or usage of oil that is not prescribed in the document. Please test/check beforehand to avoid trouble. IP ratings are not applicable to UL certification.

\*4 If the power interruption period exceeds the Backup time of the real-time clock, the error message "Initialize clock data" will be displayed when the power is turned on, and the clock data will be initialized to 00:00:00 on January 1, 2000.

## ■ EMC Specifications

|                                    |  |
|------------------------------------|--|
| Radiated Emission                  | Class A: 10m<br>40dB $\mu$ V/m quasi-peak (30M to 230MHz)<br>47dB $\mu$ V/m quasi-peak (230M to 1GHz)<br>Class A: 3m<br>76dB $\mu$ V/m (Peak), 56dB $\mu$ V/m (AVG) (1G to 3GHz)<br>80dB $\mu$ V/m (Peak), 60dB $\mu$ V/m (AVG) (3G to 6GHz) |
| Electrostatic Discharge            | Contact: $\pm$ 6kV<br>Air: $\pm$ 8kV   |
| Electromagnetic Field              | 10V/m (80M to 1000MHz)<br>3V/m (1.4G to 2.0GHz)<br>3V/m (2.0G to 2.7GHz)<br>3V/m (2.7G to 6.0GHz)<br>80% AM (1kHz)   |
| Fast Transient/Burst               | Power: $\pm$ 2kV<br>Communication cable: $\pm$ 1kV   |
| Surge Immunity                     | $\pm$ 500V (between +24V and 0V)<br>$\pm$ 500V (between +24V and FE, 0 and FE)   |
| Conducted Radio Frequency Immunity | 10V (Power, Communication cable) (150k to 80MHz)<br>80% AM (1kHz)  |

## 1.6 Dimensions

Unit: mm

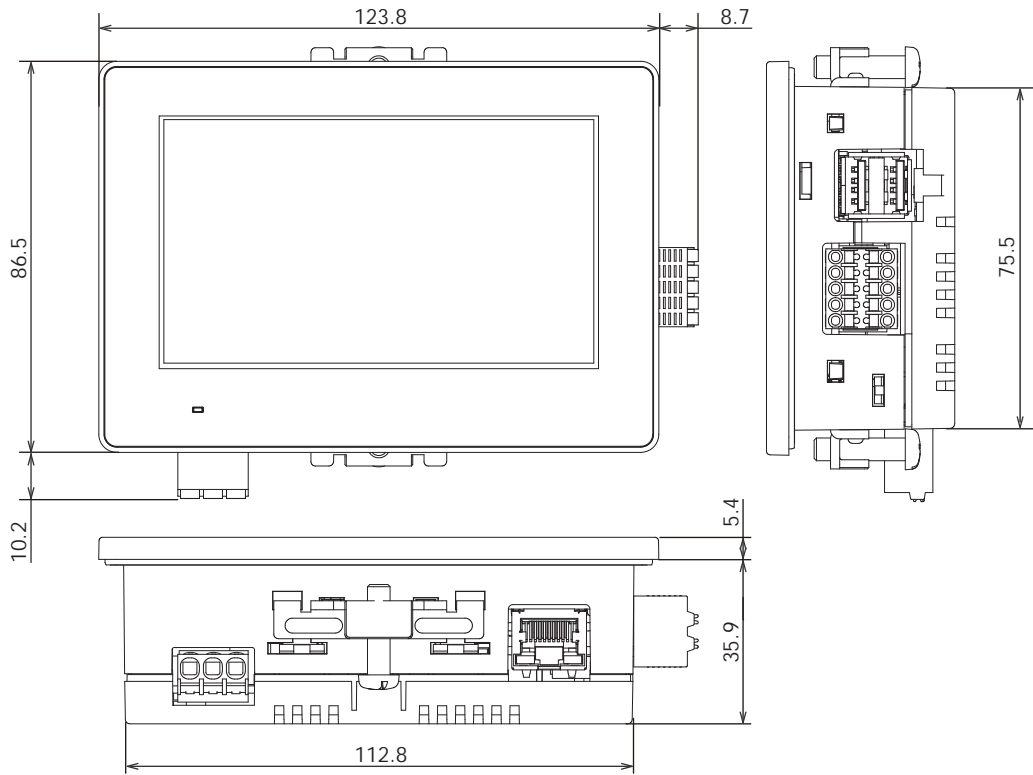

### <Cable Attached Dimensions>

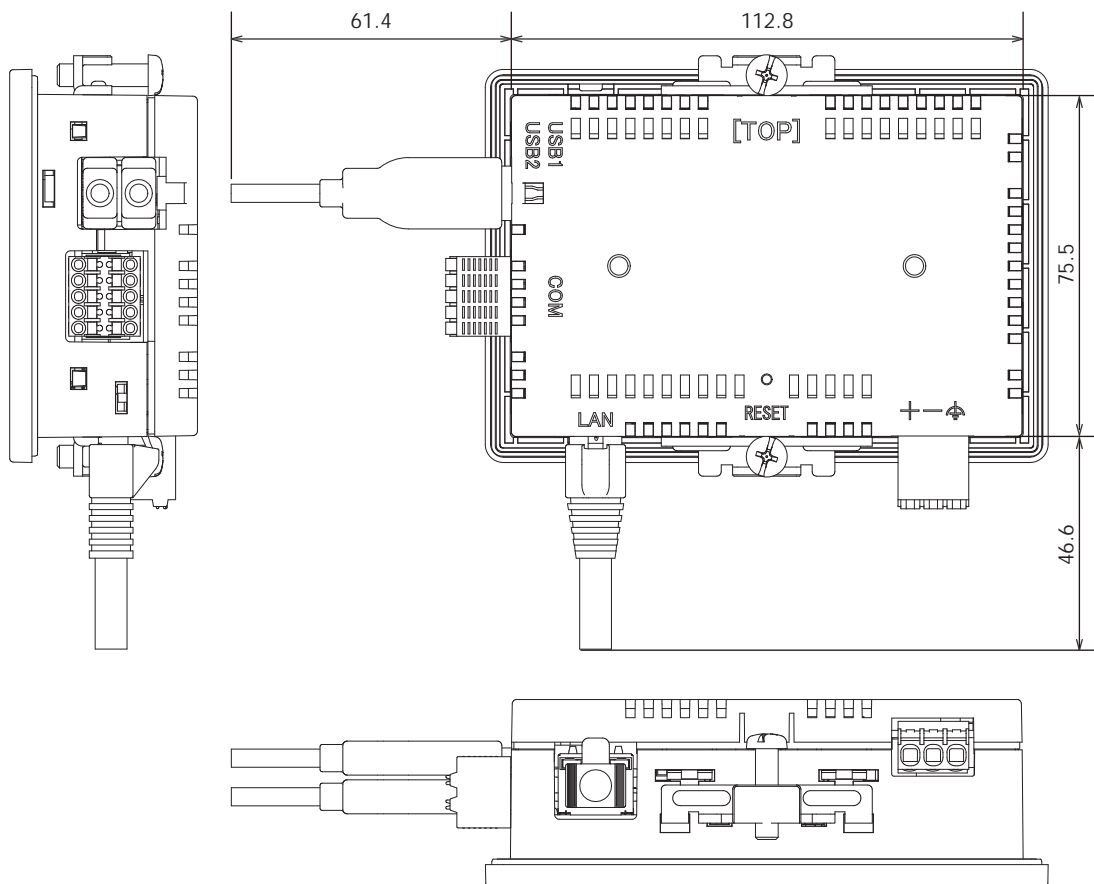

Depending on the type of connection cable used the dimensions shown above will change. The dimensions given here are representative values and are intended for reference only.



- About the printed contents of the main unit

"Mark A" indicates that you can refer to the instruction sheet using the QR code. For details, refer to "1.4 External Interfaces" on page 1-3 and "1.8 Wiring" on page 1-12.

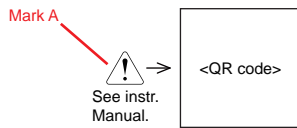

## 1.7 Installation

- Operating Environment

For designed performance and safety of the HG1J, do not install the HG1J in the following environments:

- Where dust, briny air, or iron powder exist.
- Where oil or chemical splashes for a long time.
- Where space is filled with oil mist.
- Where direct sunlight falls on the main unit.
- Where strong ultraviolet rays fall on the main unit.
- Where corrosive or combustible gasses exist.
- Where shocks or vibrations are transmitted.
- Where condensation occurs due to rapid temperature change.
- Where high-voltage or arc-generating equipment (electromagnetic contactors or circuit protectors) exists in close proximity.

- Ambient Temperature

- Allow sufficient space for ventilation, and install the equipment away from heat sources.
- Allow at least 100mm between the HG1J and walls or other equipment.
- Do not install the HG1J where the ambient temperature exceeds the rated operating ambient temperature range. When mounting the HG1J in such locations, provide a forced air-cooling fan or air-conditioner to keep the ambient temperature within the rated temperature range.
- The HG1J is designed to install on a vertical plane so that natural air-cooling is provided. If you install it using any other orientation, use forced-air cooling, or lower the ambient operating temperature.

## ● Installation

- Make a panel cut-out on the panel with the dimensions shown below.

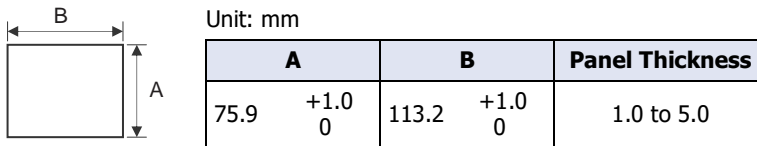

- Use the attached mounting clips to tighten the screws evenly to mount panel: screws must be applied on total of two places with the specified torque 0.3 to 0.4 N·m.

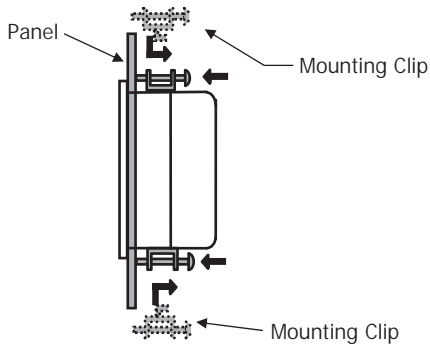

## ⚠ CAUTION

- Mount the main unit on a rigid panel.
- Do not tighten with excessive force, otherwise the main unit may warp the display, or impair the waterproof characteristics.
- If the mounting clips are tightened obliquely to the panel, the main unit may fall off the panel.
- When installing the main unit into a panel cut-out, make sure that the gasket is not twisted. Especially when re-installing, take special care because any twists in the gasket will impair the waterproof characteristics. Also, if the gasket comes off the main unit, align the convex part of the gasket with the concave part of the front case, and then insert the gasket fully into the gasket mounting groove without twisting it.

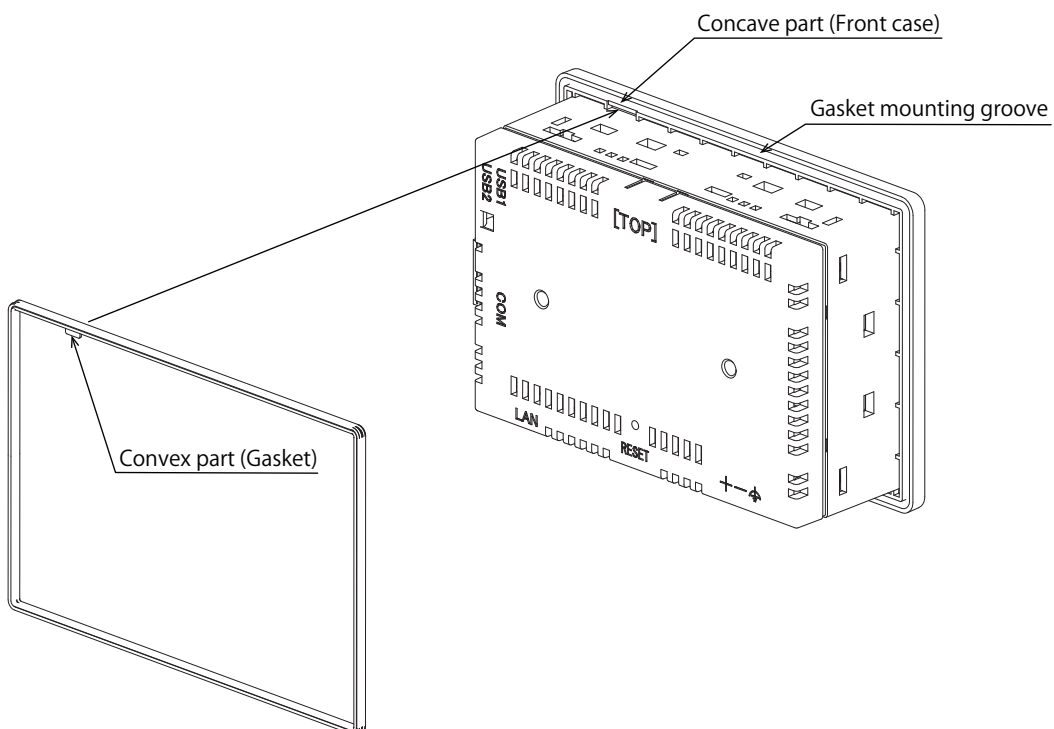

● Restrictions due to mounting orientation

The HG1J is designed to install on a vertical landscape. The ambient operating temperature and the output current of the USB interface (total of USB1 and USB2) are limited as shown in the table below.

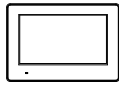
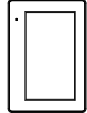
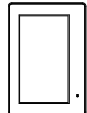
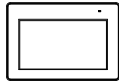
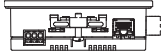
| Orientation  |   | Ambient Operating Temperature: Output current limitation of USB interface |
|--|---|---|
| Vertical   | <br>Landscape                    | -20 to +40°C: 1000 mA<br>+40 to +55°C: 500 mA                             |
|  | <br>Portrait (Clockwise)         |   |
|  | <br>Portrait (Counter Clockwise) |   |
|  | <br>Landscape (Rotate 180°)      |   |
| <br>Horizontal |   |   |



- When installing the HG1J in a diagonal, the limitations are same as a horizontal.
- Confirm the visibility of the display in a final installation.

## 1.8 Wiring

### ! CAUTION

- Turn off the power supply before wiring.
- Make the wiring as short as possible and run all wires as far away as possible from high-voltage and large-current cables. Follow all the procedures and precautions when wiring the HG1J.
- Separate the HG1J power supply wiring from the power lines of I/O devices and motor equipment.
- Ground the functional earth terminal to make sure of correct operation.
- Use the SELV (Safety Extra-Low Voltage) circuit and LIM (Limited Energy) circuit for power supply.
- Use Copper Conductors Only.

#### ● Power Supply Terminal

- Pin assignment is shown in the following table.

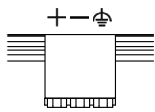

|   |                           |
|---|---------------------------|
| + | Power supply (12V/24V DC) |
| - | Power supply (0V)         |
| ⏏ | Functional Earth (FE)     |

- Use applicable cables for wiring and recommended ferrules (made by IDEC, Weidmüller or Phoenix Contact) as follows.

| Product Name                    | Power supply terminal connector<br>(Main unit's accessories)                  | Power supply terminal connector<br>(Optional parts <sup>*1</sup> )            |
|---------------------------------|---|---|
| Connector                       | Removable terminal block 3-pin (Push-in type)                                 |   |
| Applicable cable                | AWG12 to 24   | AWG12 to 26   |
| Conductor Type                  | Solid wire or Stranded wire   |   |
| Wire Strip Length <sup>*2</sup> | 10 to 11 mm   | 12 to 13 mm   |
| Recommended ferrule             | S3TL-H025-12WJ<br>S3TL-H034-12WT<br>S3TL-H05-14WA<br>S3TL-H075-14WW<br>(IDEC) | H0,25/12 HBL<br>H0,34/12 TK<br>H0,5/14 OR<br>H0,75/14 W<br>(Weidmüller)       |
|                                 | AI 0,25-8YE<br>AI 0,34-8TQ<br>AI 0,5-8WH<br>AI 0,75-8GY<br>(Phoenix Contact)  | S3TL-H025-12WJ<br>S3TL-H034-12WT<br>S3TL-H05-14WA<br>S3TL-H075-14WW<br>(IDEC) |
|                                 | H0,25/12 HBL<br>H0,34/12 TK<br>H0,5/14 OR<br>H0,75/14 W<br>(Weidmüller)       | AI 0,25-8YE<br>AI 0,34-8TQ<br>AI 0,5-8WH<br>AI 0,75-8GY<br>(Phoenix Contact)  |

\*1 FT9Z-1X03V (Right angle type)

\*2 Strip the sheath of the wire from the end.

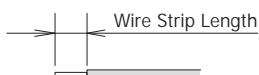

### ● Caution when inserting and removing wires

- When connecting a wire that has not been treated with a tip, such as a stranded wire, you can connect it by inserting the wire all the way in while pressing the pusher, and then releasing the pusher.
- When connecting wires with ferrules, connect the ferrules to the terminal block so that the long side is horizontal. (See the figure below.)

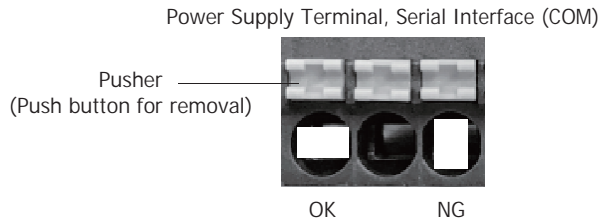

- Do not pull out the wire without pressing the pusher. When pulling out the wire, use a flat blade screwdriver, etc., and pull the wire straight out while pressing the pusher with about 20 N of force.
- Be careful not to damage the push-in terminals. When pressing the pusher, do not apply more than 40N of force.

### ● Cautions for using the HG1J connected to a personal computer

When connecting the HG1J to a personal computer via the USB Interfaces, the HG1J or the personal computer may break down depending on the conditions of the personal computer. Make sure of the following cautions, in order to prevent an accident.

- If the personal computer has a 3-pin power plug or power plug with a ground lead type, make sure to use a plug socket including a ground input electrode or ground the earth lead, respectively.
- If the personal computer has a 2-pin power plug without ground lead, follow the procedure below when connect the HG1J to the personal computer.

- (1) Pull out the power plug of the personal computer from the AC outlet.
- (2) Connect the HG1J to the personal computer.
- (3) Insert the power plug of the personal computer into the AC outlet.

### ● Recommended Tools

| Tool Name                    |                          | Model Number (Order Number) | Manufacturer |
|------------------------------|--------------------------|-----------------------------|--------------|
| Flat blade screwdriver       | Normal type              | SDS 0.4×2.5×75 (9009030000) | Weidmüller   |
|                              | With insulated cover     | S3TL-D04-25-75              | IDEC         |
| SDIS 0.4×2.5×75 (9008370000) |                          | Weidmüller                  |              |
| Crimping tool                | S3TL-CR04T<br>S3TL-CR06D |                             | IDEC         |
|                              | PZ6/5 (9011460000)       |                             | Weidmüller   |
| Stripping tool               | S3TL-ST06                |                             | IDEC         |
|                              | STRIPAX(9005000000)      |                             | Weidmüller   |

## 1.9 Maintenance and Inspection

Maintain and inspect the HG1J periodically to ensure the best performance. Do not disassemble, repair, or modify the HG1J during inspection.

| Maintenance and Inspection Parts | Description   |
|----------------------------------|---|
| Display                          | Wipe any stain of the display using a soft cloth slightly dampened with neutral detergent or alcoholic solvent. Do not use solvents such as thinner, ammonia, strong acid, and strong alkaline. |
| Terminals, Connectors            | Check the terminals and connectors to make sure of no loose screws, incomplete insertion, or disconnected lines.  |
| Mounting Clips                   | Make sure that all mounting clips and screws are tightened sufficiently. If the mounting clips are loose, tighten the screw to the specified torque.  |
| Backlight                        | The HG1J's backlight cannot be replaced by the customer. When the backlight needs to be replaced. Contact your vendor or IDEC Corporation.  |

### ● Maintenance Screen

When the following operation is performed during operation, the Maintenance Screen appears on the screen.

- Press the upper-left corner of the HG1J screen for three seconds or more.  
If the Base Screen is switched before three seconds have elapsed, the load operation for the maintenance screen will be canceled. Please press it again.

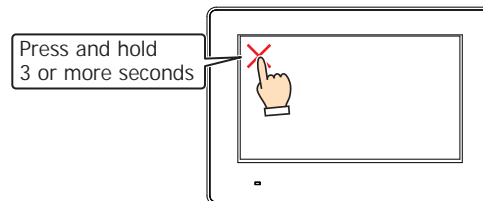

- Press the RESET switch on the back of the HG1J three times with a fine-tipped object.

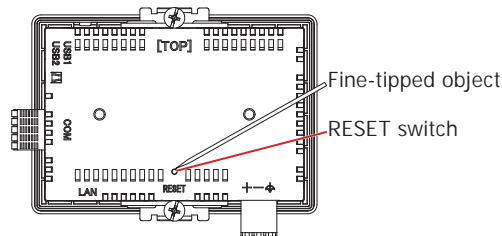

- The Maintenance Screen is not displayed in the **System Mode**.
- To display the maintenance screen, select the Enable Maintenance check box under the System tab in the Project Settings dialog box. For details, refer to Chapter 4 "3.1 System Tab" in the WindO/I-NV4 User's Manual.
- Do not touch the screen of the HG1J when operating the RESET switch.

### ● System Mode

In the System Mode, the HG1J can be changed to its initial settings and data can be initialized. Press the **System Mode** at the top of the Maintenance Screen. The Top Page Screen appears.

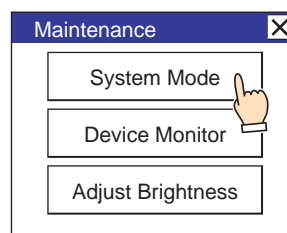

## ● Adjusting the Brightness

The brightness of the HG1J display can be adjusted on the Adjust Brightness Screen.

- 1 Press the **Adjust Brightness** at the bottom of the Maintenance Screen. The Adjust Brightness Screen appears.

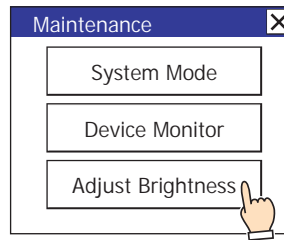

- 2 Press the << and >> at the bottom the Adjust Brightness Screen to adjust the contrast to the optimal setting.

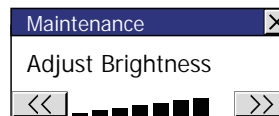

- 3 Press the **X** at the top-right to close the Adjust Brightness Screen.



To adjust the brightness in the System Mode, use the << and >> buttons located at the bottom of the Top Page.

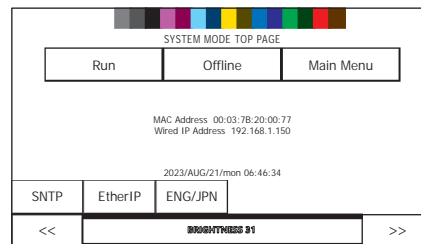

## 1.10 Software License Information

This product contains various open source software in addition to the software owned by IDEC Corporation. Information about open source software can be obtained from the QR code printed on the back of the HG1J.

# About the Warranty of the products

## 1 Warranty Period

The warranty period for IDEC products shall be three (3) year after purchase or delivery to the specified location. However, this shall not apply in cases where there is a different specification in the Catalogs or there is another agreement in place between you and IDEC.

## 2 Warranty scope

Should a failure occur in an IDEC product during the above warranty period for reasons attributable to IDEC, then IDEC shall replace or repair that product, free of charge, at the purchase location/delivery location of the product, or an IDEC service base. However, failures caused by the following reasons shall be deemed outside the scope of this warranty.

- i. The product was handled or used deviating from the conditions/environment listed in the Catalogs
  - ii. The failure was caused by reasons other than an IDEC product
  - iii. Modification or repair was performed by a party other than IDEC
  - iv. The failure was caused by a software program of a party other than IDEC
  - v. The product was used outside of its original purpose
  - vi. Replacement of maintenance parts, installation of accessories, or the like was not performed properly in accordance with the user's manual and Catalogs
  - vii. The failure could not have been predicted with the scientific and technical standards at the time when the product was shipped from IDEC
  - viii. The failure was due to other causes not attributable to IDEC (including cases of force majeure such as natural disasters and other disasters)
- \* Customers assume their own risk in programming products, Company will not be held liable for damages as a result of improper programming.

Furthermore, the warranty described here refers to a warranty on the IDEC product as a unit, and damages induced by the failure of an IDEC product are excluded from this warranty.

## 3 Service scope

The prices of IDEC products do not include the cost of services, such as dispatching technicians. Therefore, separate fees are required in the following cases.

- (1) Instructions for installation/adjustment and accompaniment at test operation (including creating application software and testing operation, etc.)
- (2) Maintenance inspections, adjustments, and repairs
- (3) Technical instructions and technical training
- (4) Product tests or inspections specified by you

# IDEC CORPORATION

 [www.idec.com](http://www.idec.com)

**Head Office** 6-64, Nishi-Miyahara-2-Chome, Yodogawa-ku, Osaka 532-0004, Japan

**USA** IDEC Corporation  
**EMEA** APEM SAS

**Singapore** IDEC Izumi Asia Pte. Ltd.  
**Thailand** IDEC Asia (Thailand) Co., Ltd.  
**India** IDEC Controls India Private Ltd.

**China** IDEC (Shanghai) Corporation  
IDEC Izumi (H.K.) Co., Ltd.  
**Taiwan** IDEC Taiwan Corporation

**Japan** IDEC Corporation

**EU Authorized Representative: APEM SAS**  
55, Avenue Edouard Herriot BP1, 82303 Caussade Cedex, France

**UK Authorized Representative: APEM COMPONENTS LIMITED**  
Drakes Drive, Long Crendon, Buckinghamshire, HP18 9BA, UK

Specifications and other descriptions in this manual are subject to change without notice.  
Information in this manual is current as of July, 2024.

2024 IDEC Corporation, All Rights Reserved.

B-2443(0)

