

Contact Arrangement (□□) : 1 a (10), 1 b (01), 1 a-1 b (11),
 2 a (20), 2 b (02), 3 a (30), 3 b (03),
 2 a-1 b (21), 1 a-2 b (12),
 2 a-2 b (22), 4 a (40), 4 b (04),
 3 a-1 b (31), 1 a-3 b (13)

Button Color (*) : RED(R), GREEN(G), BLACK(B), YELLOW(Y),
 BLUE(S), WHITE(W)

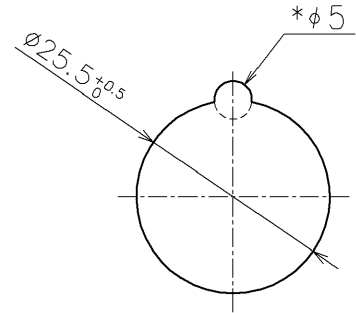

PANEL CUT-OUT

*THE $\phi 5$ RECESS IS NOT NECESSARY WHEN NEITHER NAMEPLATE NOR ANTI-ROTATION RING IS USED

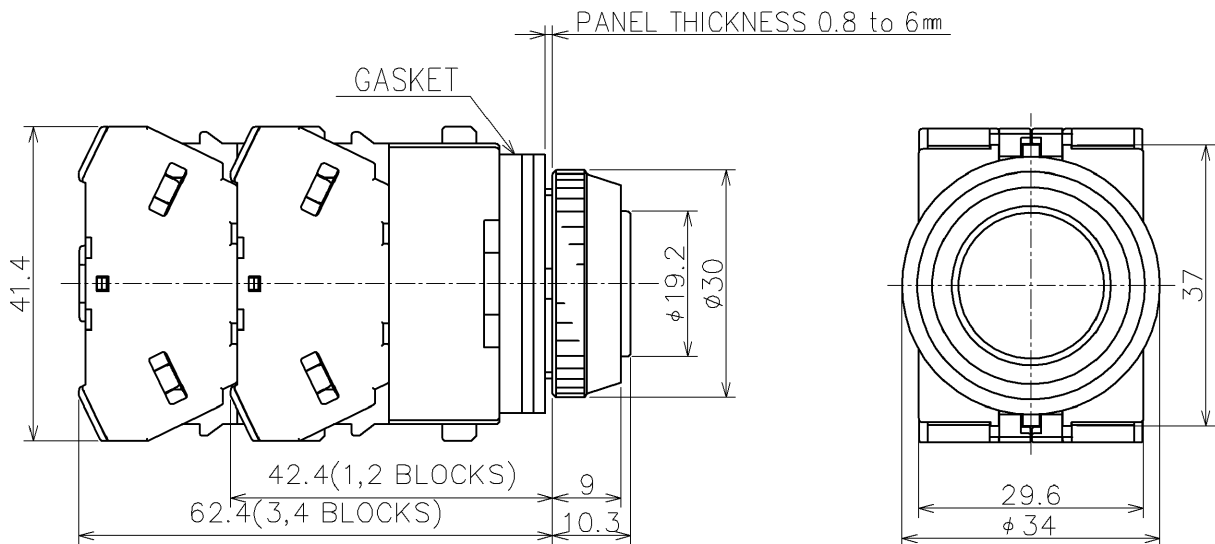
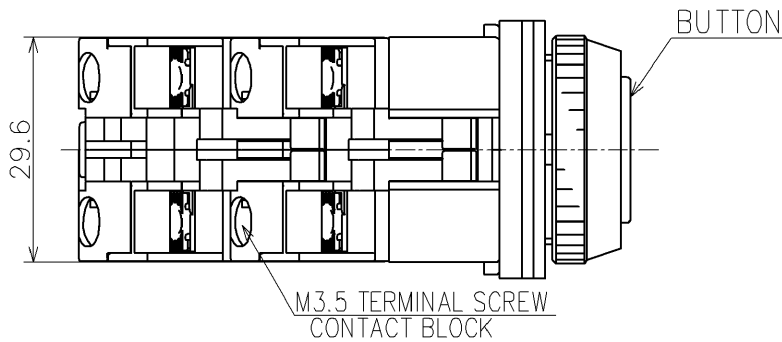

			Product Name: TWS SERIES PUSHBUTTON SWITCH	
			Type Number: ABS1 □□N*	
Approved by	M.FUJIMOTO	2023/9/25	Dim.: mm	Outside View
Checked by	Y.HANAOKA	2023/9/25	Drawing No.	
Drawn by	R.GUO	2023/9/25	MA4-A03365B	